

Instruction Manual

XW-SX70

XW-SX50

WIRELESS SPEAKER SYSTEM

Pioneer



Table of contents

Preparations

Playback

Voice Functions

Setup

Troubleshooting

Appendix

Supplementary Information

| | |
|--------------------------|----------|
| What's in the box | 3 |
| Part Names | 4 |
| Top Panel | 4 |
| Front Panel | 5 |
| Rear Panel | 6 |

Preparations

| | |
|------------------------------------|----------|
| Installation and connection | 8 |
|------------------------------------|----------|

Playback

| | |
|---------------------------------------|-----------|
| BLUETOOTH® Playback | 10 |
| Basic Operations | 10 |
| USB Memory Device | 12 |
| Basic Operations | 12 |
| Device and Supported Format | 13 |
| Connecting other Audio devices | 14 |
| Connecting with a stereo mini plug | 14 |
| Connecting with an analog audio cable | 15 |
| Analog Chain | 16 |
| Basic Operations | 16 |
| Stereo Pair | 17 |
| Basic Operations | 17 |
| Convenience functions | 19 |
| Illumination LED | 19 |

| | |
|-------------------------------|----|
| Locking this unit | 20 |
| Canceling Volume Limit | 21 |
| Emphasizing the low range | 22 |
| Adjusting the bass and treble | 23 |
| Pioneer Club Sound App | 24 |

Voice Functions

| | |
|---------------------------|-----------|
| Voice Assistant | 27 |
| Basic Operations | 27 |
| Hands Free Calling | 28 |
| Basic Operations | 28 |

Setup

| | |
|------------------------------------|-----------|
| Various settings | 30 |
| Firmware Update | 31 |
| The updating function on this unit | 31 |
| Updating via USB | 32 |

Troubleshooting

| | |
|--|----|
| When the unit is operating erratically | 34 |
| Troubleshooting | 35 |

Appendix

| | |
|-------------------------------|-----------|
| General Specifications | 37 |
|-------------------------------|-----------|

What's in the box

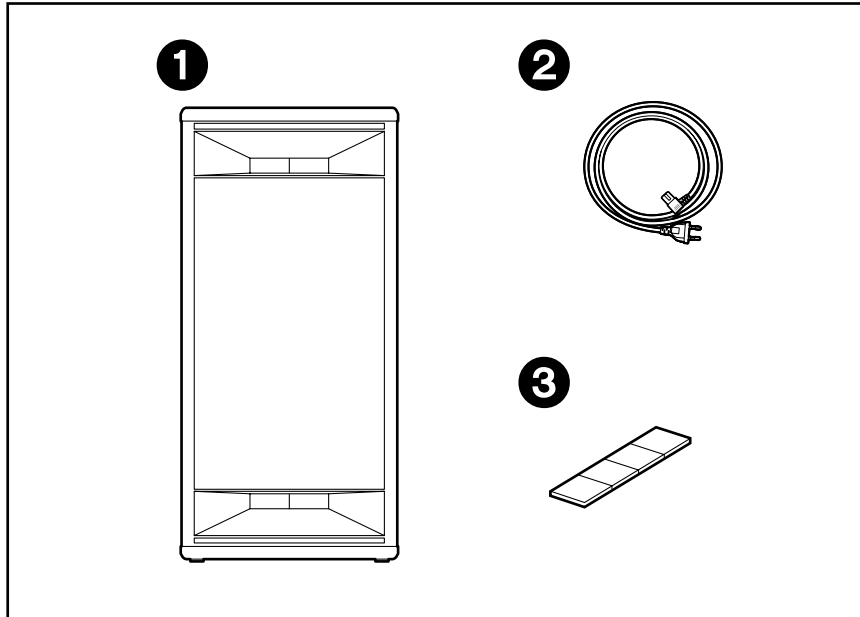

1. Main unit (1)
2. Power cord (1)
3. Feet for horizontal installation (1)
 - Quick Start Guide (1)
 - * This document is an online instruction manual. It is not included as an accessory.
 - We will not accept any responsibility for damage arising from the connection with equipment manufactured by other companies.
 - Details on the firmware update will be posted on our website and through other means at a later date.
 - Specifications and appearance are subject to change without prior notice.

Part Names

Top Panel

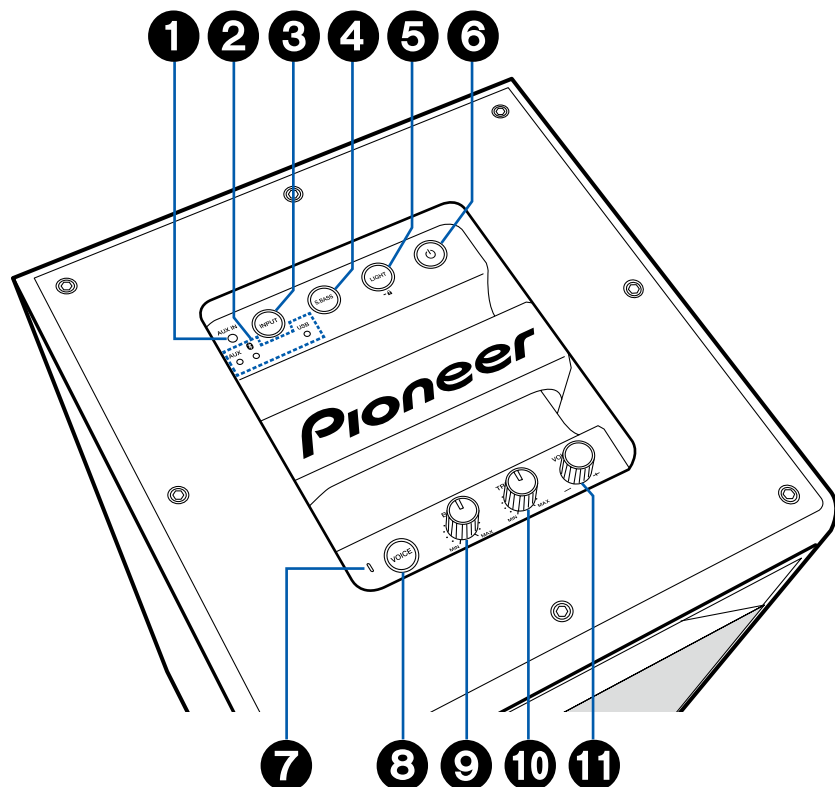

1. AUX IN Jack: Use a stereo mini plug cable ($\phi 1/8"/3.5$ mm) to input the audio from another unit. (→[p14](#))
2. Input source LED: Repeatedly pressing the INPUT button **3** causes the LED corresponding to the selected input source to light or blink.
3. INPUT button: Switches the input to be played.
4. S.BASS button (→[p22](#))
5. LIGHT button (→[p19, 20](#))
6. ⏻ button: A short press turns the power on or off.
7. Microphone: Use when the voice assistant is running and when making handsfree calls. (→[p27, 28](#))
8. VOICE button: Use to start the voice assistant and to receive and end handsfree calls. (→[p27, 28](#))
9. BASS Knob (→[p23](#))
10. TREBLE Knob (→[p23](#))
11. VOLUME Knob: Use to adjust the volume. Adjust between 0 and 50 when playing music and between 1 and 16 when the voice assistant is running and when making handsfree calls.
 - When Volume Limit (→[p21](#)) is enabled (default value), the upper limit for the volume when playing music is 45.

Front Panel

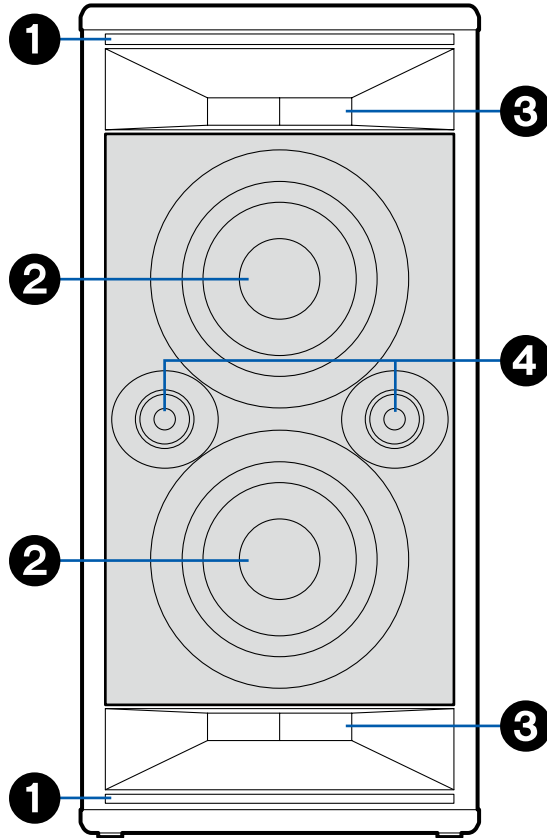

1. Illumination LED
 - The LED on the unit blinks rapidly. Turning the blinking off if it causes you to feel ill. The LED also shines very brightly, so do not look directly at it.
2. Woofer
3. Duct
4. Tweeter

Rear Panel

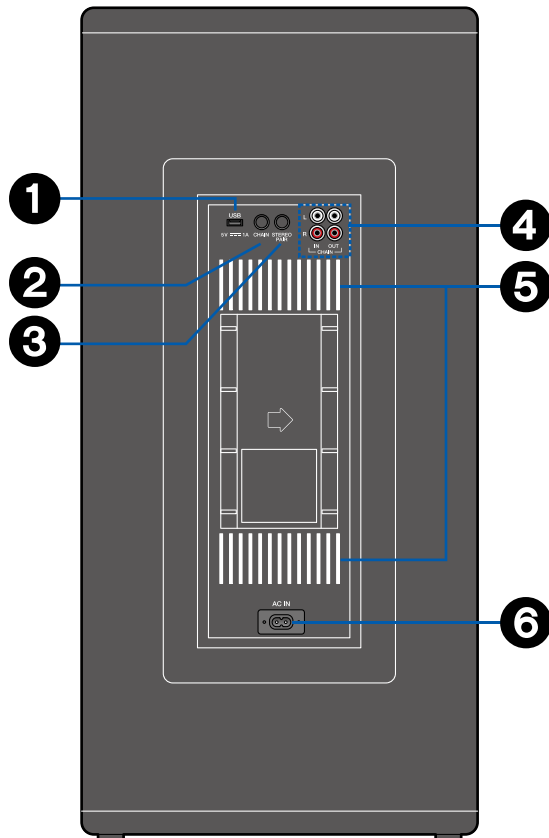

1. USB port: A USB memory device is connected so that music files stored in it can be played. (→[p12](#)) You can also supply power (5 V/1 A) to USB devices with a USB cable.
2. CHAIN button: Set this unit to analog chain mode. (→[p15, 16](#))
3. STEREO PAIR button: Use for stereo pair connection. (→[p17](#))
4. CHAIN jack: Connect a commercially available analog audio cable. (→[p15, 16](#))
5. Illumination LED
 - The LED on the unit blinks rapidly. Turning the blinking off if it causes you to feel ill. The LED also shines very brightly, so do not look directly at it. The illumination LED on the rear panel has been designed with the intention that it be viewed after being reflected from a wall.
6. AC IN: The supplied power cord is connected. (→[p8](#))

Preparations

| | |
|------------------------------------|----------|
| Installation and connection | 8 |
|------------------------------------|----------|

Installation and connection

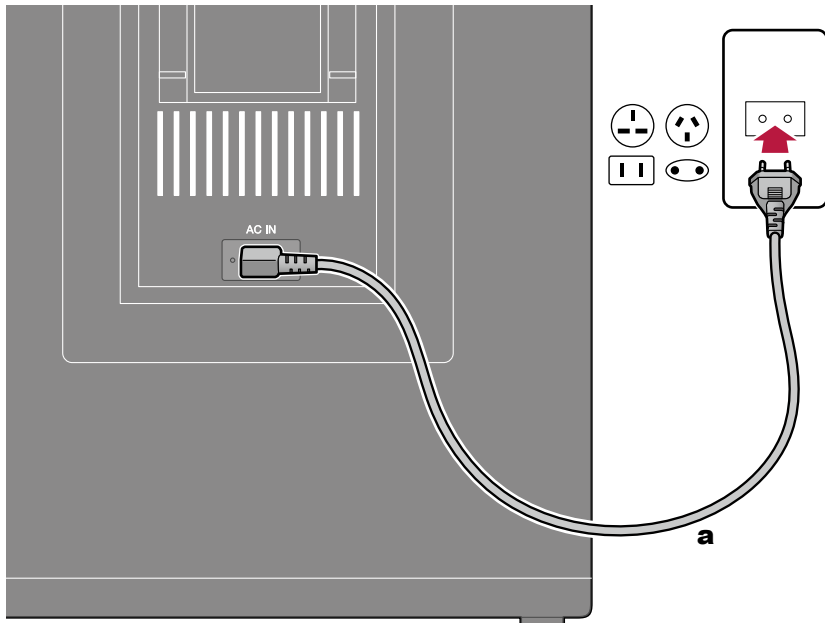

a Power cord

When installing this unit on its side, attach the feet for horizontal installation to the surface that will become the base.

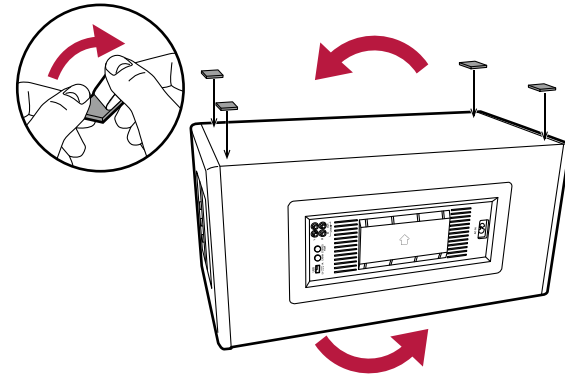

Be sure to connect the power cord to the AC IN of the unit first, and then connect it to the outlet. Always disconnect the outlet side first when disconnecting the power cord.

Playback

| | |
|---------------------------------------|-----------|
| BLUETOOTH® Playback | 10 |
| USB Memory Device | 12 |
| Connecting other Audio devices | 14 |
| Analog Chain | 16 |
| Stereo Pair | 17 |
| Convenience functions | 19 |

BLUETOOTH® Playback

You can wirelessly play the audio on a BLUETOOTH-enabled device, such as a smartphone.

Basic Operations

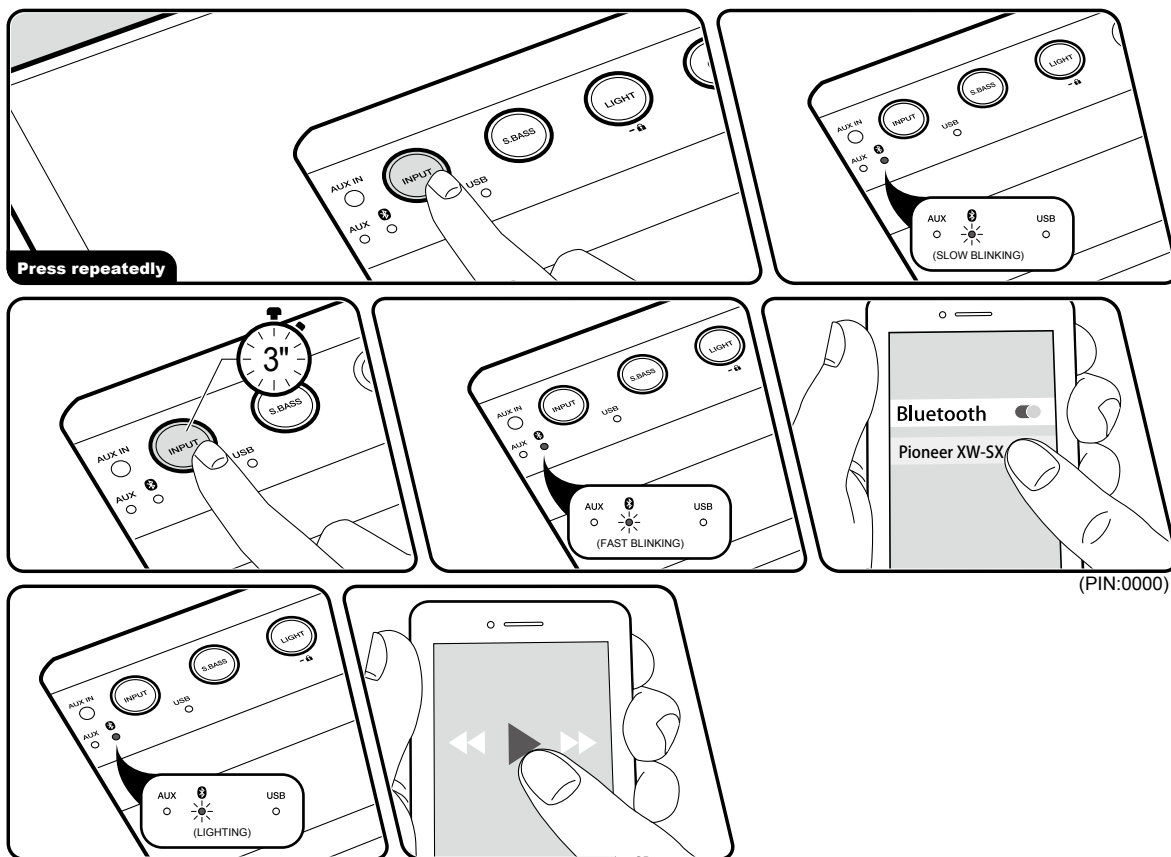

Perform the following procedure when this unit is on.

Pairing

1. Repeatedly press the INPUT button until the "AUX" LED starts to blink slowly, and change the input source to "BLUETOOTH".
2. While the "AUX" LED is blinking slowly, press and hold the INPUT button for about 3 seconds, and this causes the "AUX" LED to blink rapidly and the unit enters the pairing mode.
3. Enable (turn on) the BLUETOOTH function of the BLUETOOTH-enabled device, and then select this unit from among the devices displayed. If a password is requested, enter "0000". When connection is complete, the "AUX" LED changes from blinking to lighting.
 - This unit is displayed as "Pioneer XW-SX70 XXXXXX" or "Pioneer XW-SX50 XXXXXX".
 - To connect another BLUETOOTH wireless technology enabled device, do steps 2 and on. This unit can store the pairing information of up to 8 paired devices.
 - The coverage area is approx. 48'/15 m. Note that connection is not always guaranteed with all BLUETOOTH-enabled devices.

Playing Back

1. Perform the connection procedure on the

BLUETOOTH-enabled device. The input on this unit automatically switches to "BLUETOOTH".

2. Playing the music file.

Turn up the volume of the BLUETOOTH-enabled device to an appropriate level.

- Due to the characteristics of BLUETOOTH wireless technology, the sound produced on this unit may slightly be behind the sound played on the BLUETOOTH-enabled device.

USB Memory Device

You can play music files stored on a USB memory device.

Basic Operations

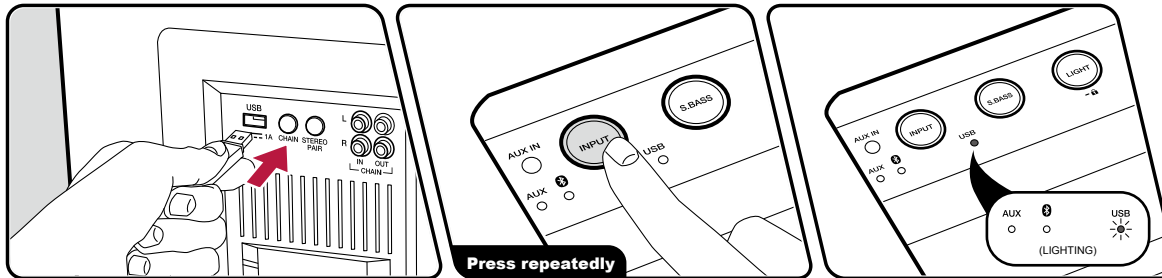

Perform the following procedure when this unit is on.

1. Plug your USB memory device with the music files into the USB port of this unit.
2. Repeatedly press the INPUT button until the "USB" LED starts to blink, and change the input source to "USB".
3. When the music files recorded on the USB memory device have been loaded, the "USB" LED changes from blinking to lighting, and play starts automatically.
 - The "USB" LED blinks slowly if there are no files that can be played on the USB memory device.
 - It is not possible to specify a folder or music file to play.
 - The order of playback is normally the order in which the music files were written to the USB memory device. However, specifications differ between USB memory devices, so it may be different to the writing order.
 - Using the Pioneer Club Sound App (→p24) enables you to control play using features such as skip and shuffle.
- The USB port of this unit complies with the USB 2.0 standard. The transfer speed may be insufficient for some content you play, and sound interruptions, etc. may occur.
- Note that operation is not always guaranteed for all USB memory devices.

Device and Supported Format

USB Memory Device Requirements

- This unit supports connection of USB memory devices (stick type) in the USB mass storage class standard. It does not support connection of other USB devices (HDD, SSD, USB card readers, etc.).
- The format of USB memory devices supports FAT16 or FAT32 file system format.
- A maximum of 255 folders and 999 files can be read. This also includes folders that contain files this unit cannot play.
- USB hubs and USB memory devices with hub functions are not supported. Do not connect these devices to the unit.
- USB memory devices with security functions are not supported on this unit.
- In use of a USB memory device, our company accepts no responsibility whatsoever for the loss or modification of data stored on a USB memory device, or malfunction of the USB memory device. We recommend that you back up the data stored on a USB memory device before using it with this unit.

kHz

- Supported bitrates: Between 32 kbps and 320 kbps, and VBR

Supported Audio Formats

This unit supports the following music file formats. Note that sound files that are protected by copyright cannot be played on this unit.

MP3 (.mp3/.MP3):

- Supported formats: MPEG-1/MPEG-2 Audio Layer 3
- Supported sampling rates: 32 kHz, 44.1 kHz, 48

Connecting other Audio devices

You can connect another audio device, input the audio to this unit and play it back.

Connecting with a stereo mini plug

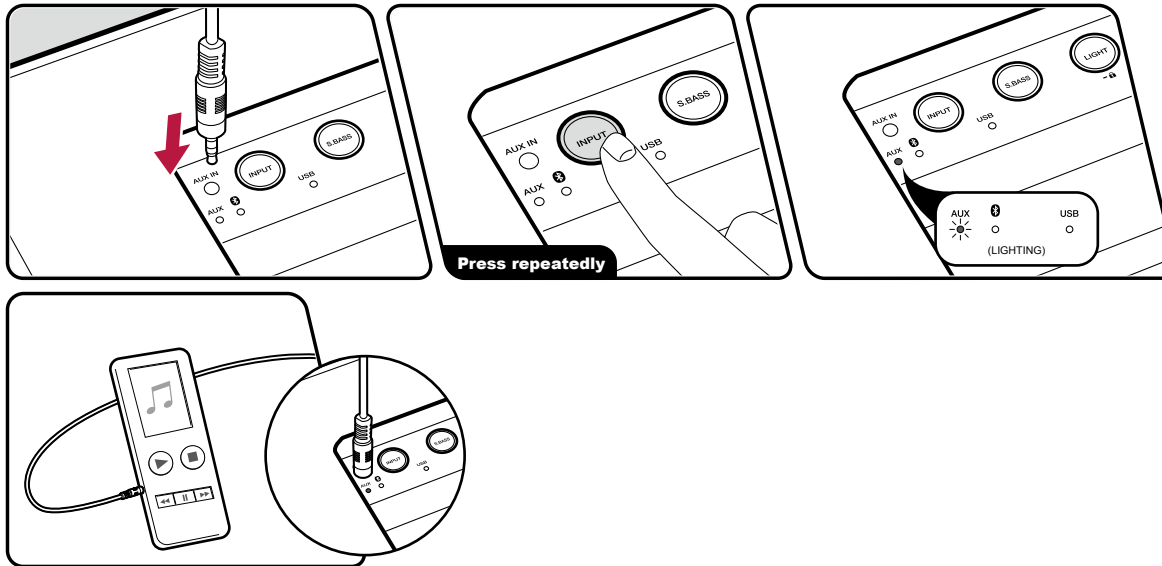

1. After connecting a stereo mini plug cable (ø1/8"/3.5 mm) to the AUX IN jack on this unit and the audio device, turn on the power of this unit and the connected device.
2. Repeatedly press the INPUT button until the "AUX" LED lights, and change the input source to "AUX".
3. Start play on the connected audio device. Increase the volume of the audio device to an appropriate level.
 - When connecting this unit to an audio device with a LINE OUT jack, such as a CD player, connect using an analog audio cable to prevent clipping. (→p15)

Connecting with an analog audio cable

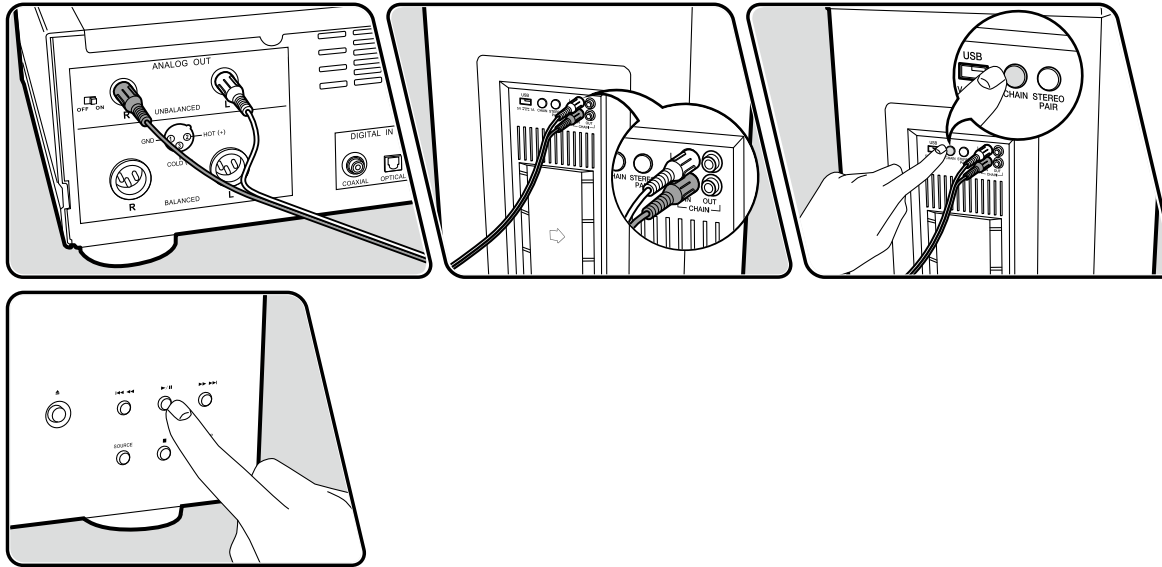

1. After connecting the LINE OUT jack on the audio device and the CHAIN IN jack on the rear panel of this unit using an analog audio cable, turn on the power of this unit and the connected device.
2. Press the CHAIN button on the rear panel of the unit so that all of the "AUX", "S", and "USB" LED light, and turn on the analog chain mode.
 - You can also set to the analog chain mode by repeatedly pressing the INPUT button.
3. Start play on the connected audio device.

Analog Chain

When two or more of these units are connected using commercially available analog audio cables, it is possible to simultaneously play music from a BLUETOOTH wireless technology enabled device, USB memory, or AUX connection. Connect the player to the unit that will become the main unit.

Basic Operations

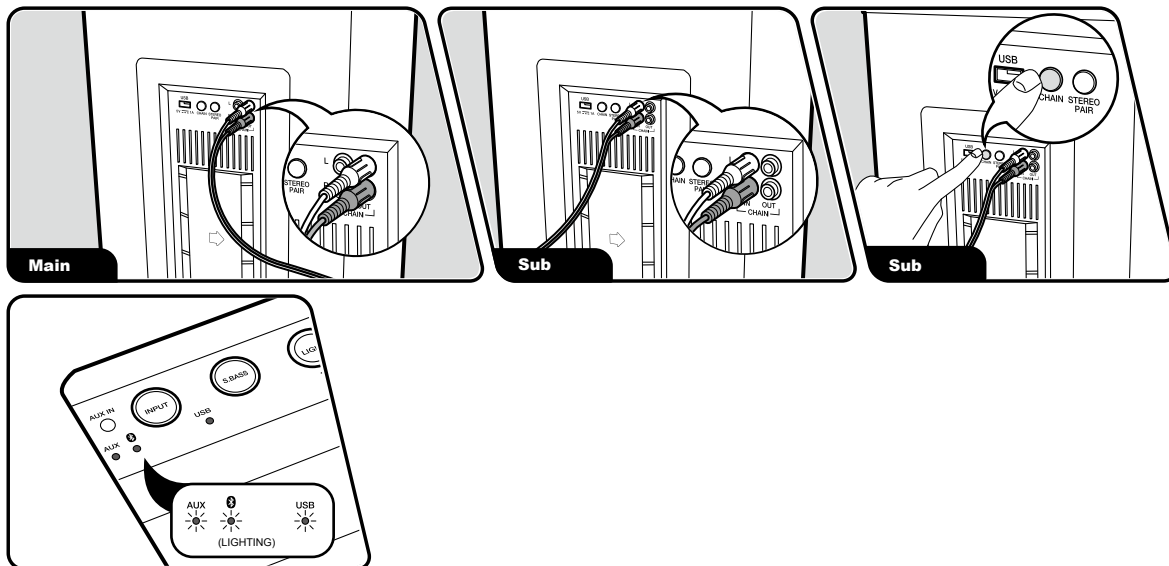

1. Connect the CHAIN OUT jack on the first unit (main unit) to the CHAIN IN jack on the second unit (sub unit) with an analog audio cable.
2. Turn on the power of the main unit and the sub unit.
3. Press the CHAIN button on the sub unit so that all of the "AUX", "BT", and "USB" LED light, and turn on the analog chain mode.
 - You can also set to the analog chain mode by repeatedly pressing the INPUT button.
4. Play the music files on the main unit.
 - When connecting a third unit, connect the CHAIN OUT jack on the second unit to the CHAIN IN jack on the third unit with an analog audio cable, then press the CHAIN button on the third unit.

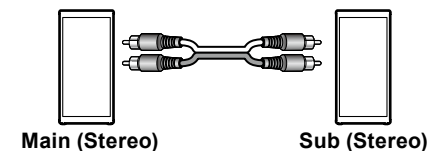

Stereo Pair

It is possible to play the music from a BLUETOOTH wireless technology enabled device through two of these units at the same time. Pair the BLUETOOTH wireless technology enabled device with the unit that will become the main unit. (→p10)

Basic Operations

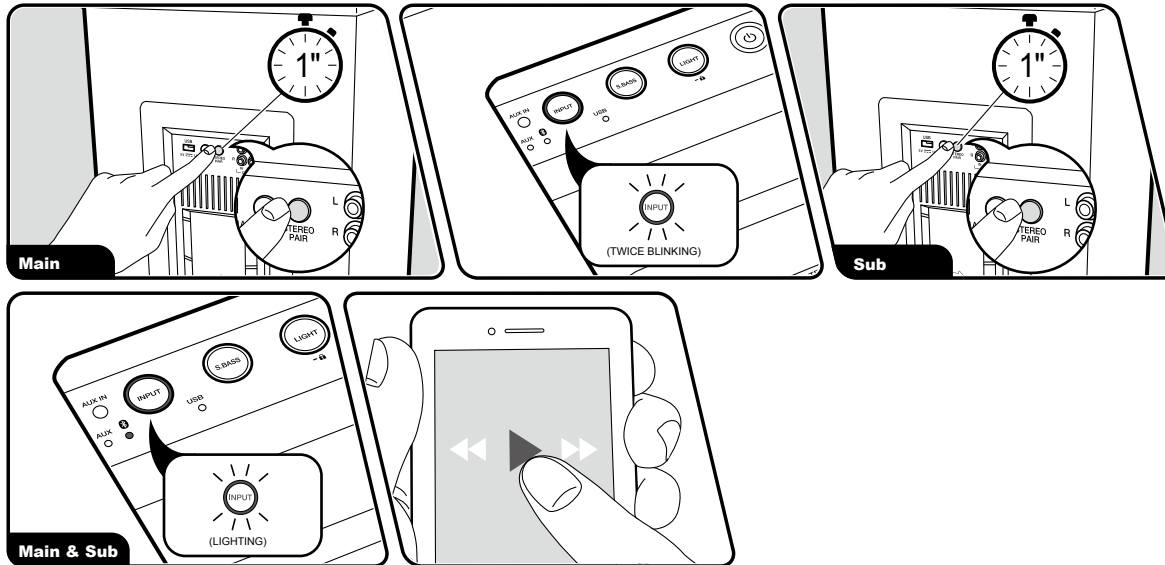

Perform the following procedure when this unit is on.

1. Repeatedly press the INPUT buttons on the first unit (main unit) and the second unit (sub unit) until the "8" LEDs start to blink slowly, and change the input source to "BLUETOOTH".
2. Press and hold the STEREO PAIR button on the main unit for 1 second. The INPUT button blinks twice.
3. Press and hold the STEREO PAIR button on the sub unit for 1 second. Pairing is complete when the INPUT buttons on the main unit and the sub unit change to being lit.
4. Play the BLUETOOTH wireless technology enabled device after connecting it to the main unit via BLUETOOTH.
 - You cannot pair with the sub unit during play.

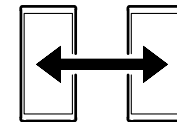

Main (Stereo) Sub (Stereo)

- Use stereo pair connection with two units with the same model number. Connecting units with different model numbers will mean the balance of the volume, etc., will not be right.
- When you change the volume on one unit during

play, the volume on the other unit changes in conjunction.

- Stereo pair will not be canceled even after you turn the power on again after turning it off. Stereo pair is canceled when you either press and hold the STEREO PAIR button or change the INPUT selector on the main unit or sub unit.
- If a call is received during stereo pair connection, only the main unit emits the ringtone. (→[p28](#))

Change the playback mode

- This feature is available after firmware update and on devices with new firmware installed during manufacture. If operation is not possible, refer to Firmware Update (→[p31](#)) to update the firmware.
1. Change the audio output mode. The front illumination LED lights for about 2 seconds when you press the STEREO PAIR button to enable you to see the setting status. The output mode switches when you repeatedly press the STEREO PAIR button while the front illumination LED is on, and the color of the LED also changes.

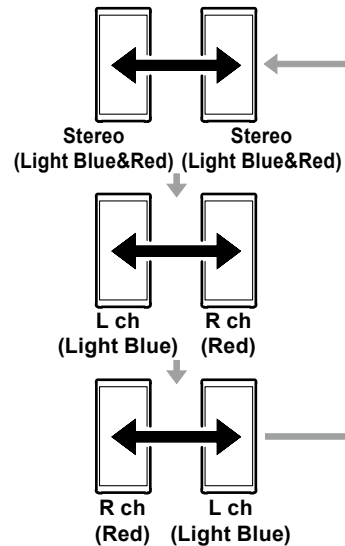

Convenience functions

Illumination LED

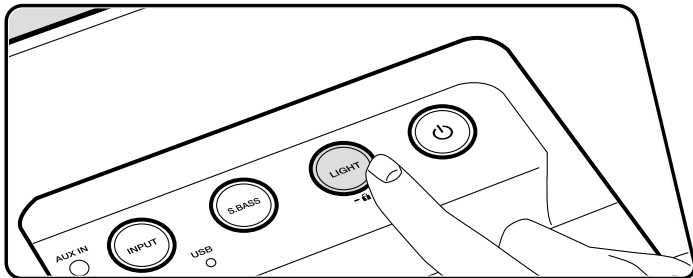

You can change how the illumination LED on the front and back of the unit blink.

1. Repeatedly press the LIGHT button to change the way the illumination LED blink. (Rave→Chill→Off→Rave...)
 Rave: Compared to chill, the blinking is faster and color transitions are also faster. Illumination also modifies if kick (BassDrum) is detected in the track.
 - Kick may not be detected depending on the connected audio device and track being played.
 Chill: Compared to rave, the blinking is slower and color transitions are also slower. The illumination does not change when kick is detected if you have selected chill.
 - If the unit is off, select either the mode where LED blink randomly or LED off.

Locking this unit

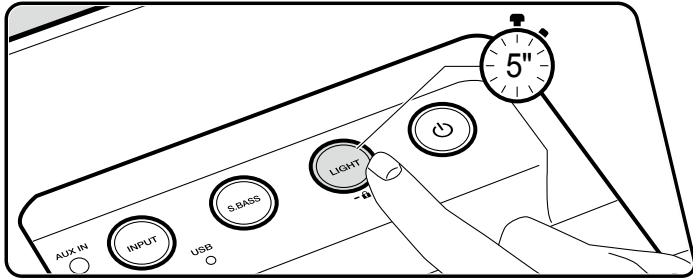

When the LIGHT button is pressed and held for about 5 seconds, the LIGHT button blinks and the operations are locked for the buttons and VOLUME knob of the unit. To unlock, press and hold the LIGHT button again for about 5 seconds.

- Even if you lock this unit, the BASS knob and TREBLE knob (→[p23](#)) are not locked.

Canceling Volume Limit

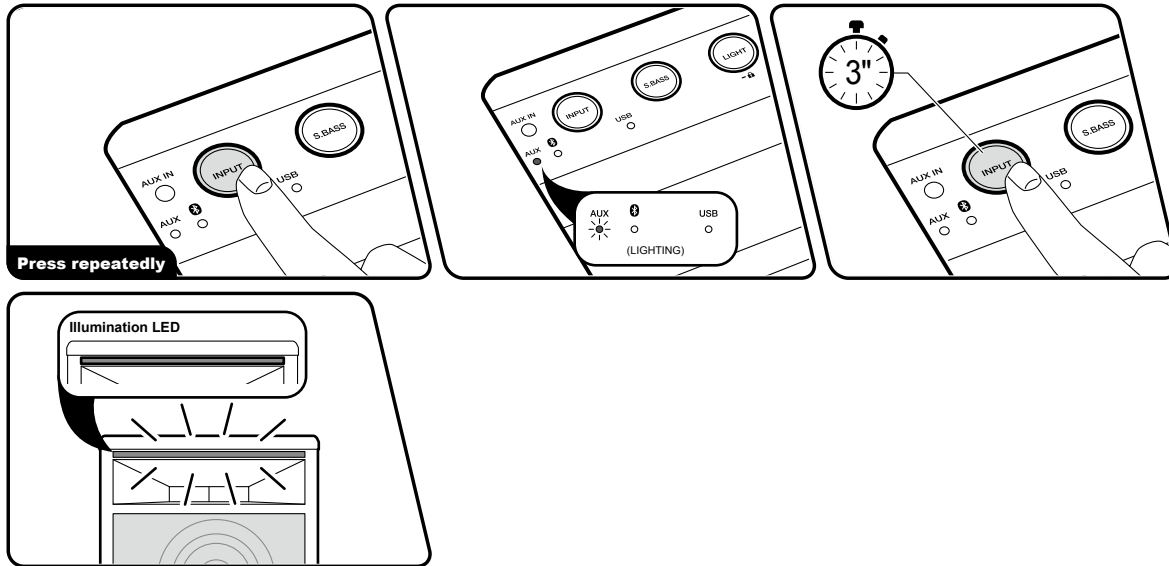

You can cancel the upper limit setting for volume when playing music. When you cancel the upper limit for the volume, the maximum volume increases from 45 to 50.

- This feature is available after firmware update and on devices with new firmware installed during manufacture. If operation is not possible, refer to Firmware Update (→p31) to update the firmware.
1. Repeatedly press the INPUT button until the "AUX" LED lights, and change the input source to "AUX".
 2. Press and hold the INPUT button for about 3 seconds to cancel the setting. When the setting is canceled, the front panel illumination LED blinks red twice. When you press and hold the INPUT button again for about 3 seconds, the front panel illumination LED blinks blue twice and the Volume Limit is enabled.
- The volume setting can still be set between 46 to 50 when Volume Limit is enabled, but the volume actually output will remain at 45.
 - Depending on the track, abnormal sound may be generated when playing at or near maximum volume with the Volume Limit turned off.

Emphasizing the low range

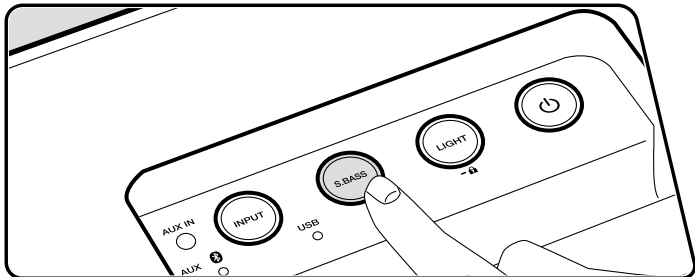

When you press the S.BASS button, the S.BASS button LED lights and the unit switches to the mode for emphasizing the bass. To turn off, press the S.BASS button again.

Adjusting the bass and treble

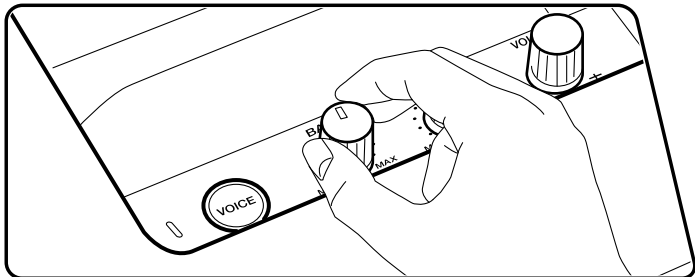

Turn the BASS knob or TREBLE knob to adjust the sound quality.

BASS: Adjust the volume of the bass between -6 dB and +6 dB.

TREBLE: Adjust the volume of the treble between -6 dB and +6 dB.

Pioneer Club Sound App

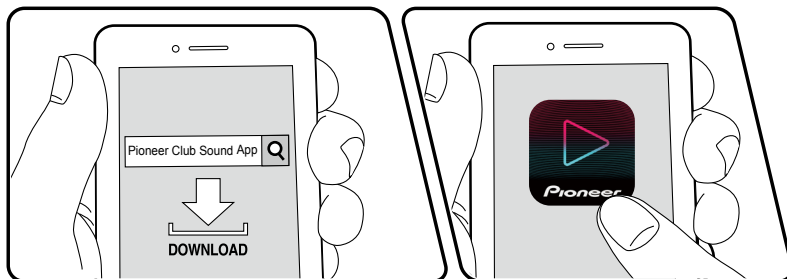

By downloading the Pioneer Club Sound App (available on iOS and Android™) to a mobile device such as a smartphone or tablet, you can control USB play (→[p12](#)) on this unit using features such as pause, skip, repeat, and shuffle. You can also set convenient features such as mute and the sleep timer. Furthermore, features such as preset registration using the sharing features of music distribution services such as Spotify and adjusting the brightness of the LED illumination become available.

- This feature is available after firmware update and on devices with new firmware installed during manufacture. If operation is not possible, refer to Firmware Update (→[p31](#)) to update the firmware.

Perform the following procedure when this unit is on.

1. Download the Pioneer Club Sound App from the App Store or Google Play™ Store.
2. Connect this unit to a mobile device via BLUETOOTH (→[p10](#)).
3. Start the Pioneer Club Sound App.
4. Tap this unit in the list of devices displayed in the Device List screen. The app requests you to authorize the connection and the INPUT, S.BASS, and LIGHT buttons on this unit blink. Press and hold the VOICE button for about 3 seconds to allow the connection.
 - When the request to authorize connection comes from the app while the power of this unit is off, authorization standby is cleared when the power is turned on.

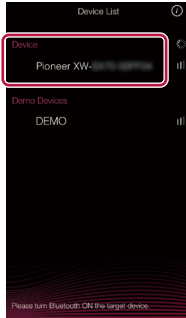

5. A screen for setting a name is displayed, so select a name.

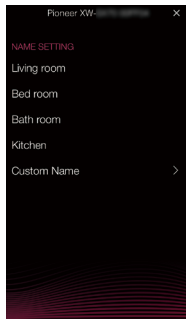

6. Initial settings are complete when the Volume setting screen is displayed.

Music Service

You can register presets using the sharing features of music distribution services. The Preset screen is displayed by swiping the screen left or right. Tap the preset number you want to register. A list of music distribution service apps is displayed when you tap the number. Select the content you want to register and share to the Pioneer Club Sound App.

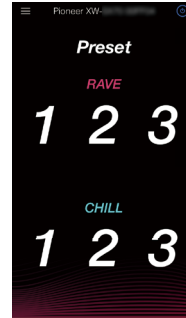

- The method for sharing depends on the music distribution service.
- A maximum of 6 presets can be registered.

Voice Functions

| | |
|---------------------------|-----------|
| Voice Assistant | 27 |
| Hands Free Calling | 28 |

Voice Assistant

You can start the voice assistant feature on a smartphone connected to this unit via BLUETOOTH.

Basic Operations



Perform the following procedure when this unit is on.

1. Connect this unit to a smartphone that has a voice assistant feature via BLUETOOTH.
(→p10)
2. Press the VOICE button on this unit.
The voice assistant feature on the smartphone starts up.
3. Speak into the microphone on this unit.
The voice assistant recognizes the question and the answer comes from the speaker of this unit.
 - This may not be supported in some cases due to the smartphone specifications or app version.

Hands Free Calling

Hands Free calls require a BLUETOOTH connection to a mobile phone that supports the Hands Free Profile or Headset Profile. (→p10)

Basic Operations

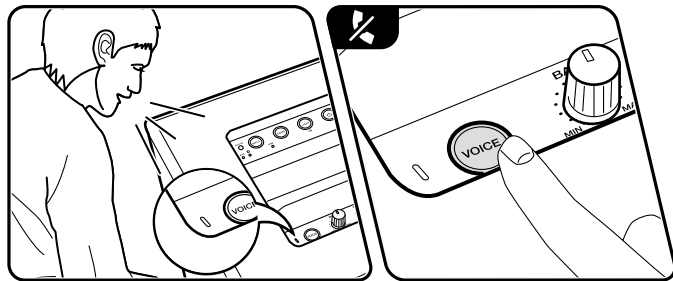
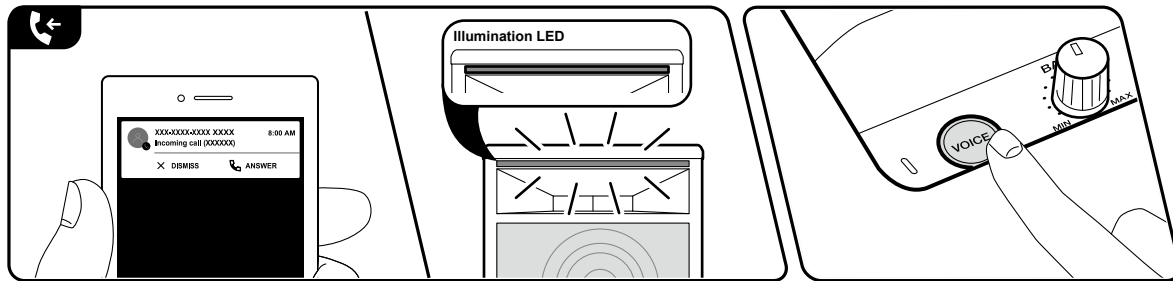

Perform the following procedure when this unit is on.

Take a call

1. When the mobile phone connected via BLUETOOTH receives a call, the front illumination LED blinks green.
2. Press the VOICE button on this unit to start the call. The front illumination LED lights green.
 - To reject the call, press and hold the VOICE button for about 2 seconds.
3. Speak into the microphone on this unit. Adjust the volume during the call with the VOLUME knob.
 - By pressing and holding the VOICE button for about 2 seconds during a call, you can switch the audio output to the speaker of the mobile phone.
4. Press the VOICE button to hang up.

Make a call

1. Operate the mobile phone connected via BLUETOOTH to make the call.
2. When the phone is in a call, the front illumination LED lights green.
3. Speak into the microphone on this unit. Adjust the volume during the call with the VOLUME knob.
 - By pressing and holding the VOICE button for about 2 seconds during a call, you can switch the audio output to the speaker of the mobile phone.
4. Press the VOICE button to hang up.

Setup

| | |
|-------------------------|-----------|
| Various settings | 30 |
| Firmware Update | 31 |

Various settings

You can configure advanced settings to have a more enjoyable experience with this unit.

| Setting Item | Default Value | Setting Details |
|------------------|---------------|---|
| Auto Standby | On | <p>This setting allows the unit to enter standby mode automatically after 20 minutes of inactivity without any audio input.</p> <p>With the input selector at AUX, press and hold the STEREO PAIR button for about 1 second and confirm the setting status.</p> <p>You can turn on or off by pressing and holding the STEREO PAIR button for about 3 seconds.</p> <p>"On": The unit automatically enters standby mode. (The front panel illumination LED lights or blinks blue)</p> <p>"Off": The unit does not automatically enter standby mode. (The front panel illumination LED lights or blinks red)</p> |
| BLUETOOTH Wakeup | On | <p>This function wakes up the unit on standby by connecting a BLUETOOTH-enabled device.</p> <p>With the input selector at AUX, press and hold the S.BASS button for about 1 second and confirm the setting status.</p> <p>You can turn on or off by pressing and holding the S.BASS button for about 3 seconds.</p> <p>"On": When this function is used. (The front panel illumination LED lights or blinks blue)</p> <p>"Off": When this function is not used. (The front panel illumination LED lights or blinks red)</p> |

| Setting Item | Default Value | Setting Details |
|--------------|---------------|---|
| BLUETOOTH | On | <p>Select whether or not to use the BLUETOOTH function.</p> <p>With the input selector at AUX, press and hold the CHAIN button for about 1 second and confirm the setting status.</p> <p>You can turn on or off by pressing and holding the CHAIN button for about 3 seconds.</p> <p>"On": Enables connection with a BLUETOOTH wireless technology enabled device by using the BLUETOOTH function. Select "On" also when making various BLUETOOTH settings. (The front panel illumination LED lights or blinks blue)</p> <p>"Off": When not using the BLUETOOTH function. (The front panel illumination LED lights or blinks red)</p> |

Firmware Update

The updating function on this unit

This unit has functionality to update the firmware (the system software) by the USB port. This function can improve various operations and add various functions.

- For the latest information on updates, visit our company's website. If there is no update available, updating the firmware of this unit is not necessary.
- While updating the firmware, do not do the following:
 - Unplug cables, disconnect USB memory devices, or perform operations such as turning off the power as these can cause malfunctions
- Updating can take up to a maximum of 5 minutes. Existing settings are maintained even after updating.

Disclaimer: The program and accompanying online documentation are furnished to you for use at your own risk.

Our company will not be liable and you will have no remedy for damages for any claim of any kind whatsoever concerning your use of the program or the accompanying online documentation, regardless of legal theory, and whether arising in tort or contract.

In no event will our company be liable to you or any third party for any special, indirect, incidental, or consequential damages of any kind, including, but not limited to, compensation, reimbursement or damages on account of the loss of present or prospective profits, loss of data, or for any other reason whatsoever.

Updating the Firmware via USB (→[p32](#))

Updating via USB

- Prepare a 128 MB or larger USB memory device. The format of USB memory devices supports FAT16 or FAT32 file system format.
 - Media inserted into a USB card reader may not be used for this function.
 - USB memory devices equipped with the security function are not supported.
 - USB hubs and USB devices equipped with the hub function are not supported. Do not connect these devices to the unit.
 - Delete any data stored on the USB memory device.
 - * Depending on the USB memory device or its content, long time may be required for loading, the content may not be loaded correctly, or power may not be supplied correctly.
 - * Our company will not be liable whatsoever for any loss or damage of data, or memory failure arising from the use of the USB memory device. Please note this in advance.
 - Update has failed if any of INPUT, S.BASS, or LIGHT blink rapidly. If update fails, press the **⏻** button to turn the power on. Update recovery is executed automatically.
 - If the VOICE button blinks rapidly, confirm that the file has been correctly stored on the USB memory and do the update procedure again starting at step 1.
5. Update is complete when this unit turns off automatically. The unit is now updated with the latest firmware.
 6. Disconnect the USB memory device from the unit.

Update

Preparation:

1. Connect the USB memory device to your PC.
2. Download the firmware file from our company's website to your PC and unzip. Firmware files are named as below.
SCS1001_***.zip
Unzip the file on your PC.
3. Copy "SCS1001.of1" file to the root folder of the USB memory device.
 - Make sure to copy the unzipped file.

Update procedure:

1. With the USB memory disconnected, press **⏻** button to turn the power on.
2. Repeatedly press the INPUT button to switch the input source to "USB".
3. Press and hold the CHAIN button for about 5 seconds. The INPUT, S.BASS, and LIGHT button LEDs blink.
4. Within 20 seconds of the INPUT, S.BASS, and LIGHT button LEDs changing from blinking to steady illumination, connect the USB memory to the USB port of this unit.
The update starts and the INPUT, S.BASS, and LIGHT button LEDs blink in turn to indicate the progress of the update.

Troubleshooting

Before starting the procedure

Problems may be solved by simply turning the power on/off or disconnecting/connecting the power cord, which is easier than working on the connection, setting and operating procedure. Try the simple measures on both the unit and the connected device. After reconnecting, turn off and on the unit and the connected device.

- The unit contains a microPC for signal processing and control functions. In very rare situations, severe interference, noise from an external source, or static electricity may cause it to lockup. In the unlikely event that this happens, unplug the power cord from the wall outlet, wait at least 5 seconds, and then plug it back in.

When the unit is operating erratically **34**

Try restarting the unit **34**

Resetting the unit (this resets the unit settings to the default) **34**

Troubleshooting **35**

■ Power **35**

■ Audio **35**



■ BLUETOOTH function **35**

■ USB Memory Device **36**

■ Others **36**

When the unit is operating erratically

Try restarting the unit

Restarting this unit may solve the problem. Press and hold the  button for 5 seconds or longer while the unit is on. When the LED on the top panel goes out, release your finger, then press the  button again to turn the unit on. (The settings on this unit are kept.) If the issue is not fixed by restarting, try unplugging this unit's power cord and then plugging it in again.

Resetting the unit (this resets the unit settings to the default)

If the restart of the unit does not solve the problem, reset the unit, and restore all the settings to the factory default at the time of purchase. This may solve the problem. If the unit is reset, your settings are restored to the default values. To reset, while pressing the LIGHT button, press and hold the CHAIN button for about 2 seconds.

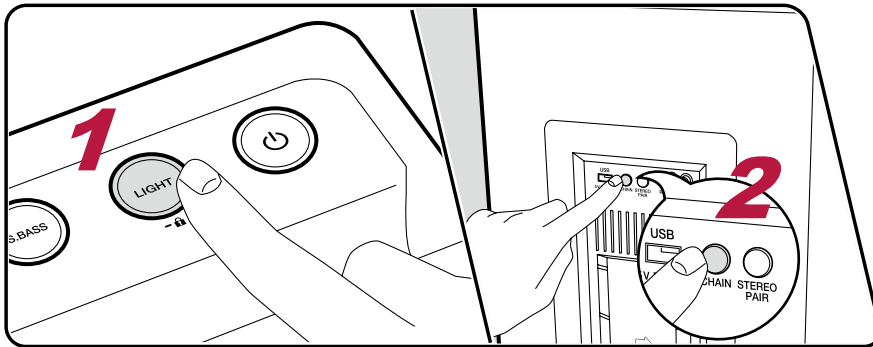

Troubleshooting

■ Power

Cannot turn on the unit

- Make sure that the power cord is properly plugged into the wall outlet.
- Unplug the power cord from the outlet once, wait 5 seconds or more, then plug it in again.

(→p8)

The unit turns off unexpectedly

- The unit automatically enters standby mode when "Auto Standby" is activated.
- The protection circuit function may have operated due to an abnormal rise in temperature of the unit. In such a case, the power turns off repeatedly even if the power is turned on each time. Secure sufficient ventilation space around the unit, wait for a while until the temperature of the unit decreases. Then, turn the power on again.

(→p30)

WARNING: If smoke, smell or abnormal noise is produced by the unit, unplug the power cord from the outlet immediately, and contact the dealer or our company's support.

■ Audio

No sound from a connected player

- Change the input selector on this unit to the position of the terminal to which the player is connected.

■ BLUETOOTH function

- Unplug and plug the power cord of the unit, or turn off and on the BLUETOOTH-enabled device. Restart of the BLUETOOTH-enabled device may be effective.
- BLUETOOTH-enabled devices must support the A2DP profile.
- Because a radio wave interference will occur, this unit may not be used near devices such as a microwave oven or cordless phone which use the radio wave in the 2.4 GHz range.
- A metallic object near the unit can affect on the radio wave, and BLUETOOTH connection may not be possible.

Check the following if the problem persists after you have confirmed the above.

Cannot connect with this unit

- Check if the BLUETOOTH function of the BLUETOOTH-enabled device is enabled.

(→p10)

Music playback is unavailable on the unit even after successful BLUETOOTH connection

- When the audio volume of your BLUETOOTH-enabled device is set low, the audio may not be played back. Turn up the volume of the BLUETOOTH-enabled device.
- Depending on the BLUETOOTH-enabled device, the Send/Receive selector switch may be equipped. Select Send mode.
- Depending on the characteristics or specifications of the BLUETOOTH-enabled device, music may not be played back on this unit.

Sound is interrupted

- There may be a problem with the BLUETOOTH-enabled device. Check the information on a web page.

The audio quality is poor after connection with a BLUETOOTH-enabled device

- The BLUETOOTH reception is poor. Move the BLUETOOTH-enabled device closer to the unit, or remove any obstacle between the BLUETOOTH-enabled device and this unit.

■ USB Memory Device

USB memory device not recognized

- Check if the USB memory device is securely inserted to the USB port of the unit.
- Disconnect the USB memory device once from the unit, and then reconnect it.
- Depending on the type of content, the playback may not be performed normally. Check the types of supported file formats.
- Operations of USB memory devices equipped with security functions are not guaranteed.

(→p12)

■ Others

Strange noise can be heard from the unit

- If you have connected another device to the same outlet as this unit, strange noise may occur under the influence of the device. If the symptom is remedied by removing the power plug of the other device from the outlet, use different outlets for this unit and the device.

General Specifications

■ Amplifier Section

- RMS Output Power
 - SX70: 100 + 100 W at 4 ohms, 1 kHz, 2 ch driven of 10 % THD
 - SX50: 60 + 60 W at 4 ohms, 1 kHz, 2 ch driven of 10 % THD
- Input Sensitivity and Impedance
 - 800 mV/47 kΩ (CHAIN IN)
 - 400 mV/47 kΩ (AUX IN)
- Rated RCA Output Voltage and Impedance
 - 2 V/780 Ω (CHAIN OUT)
- Tone Control Characteristics
 - +6 dB, 20 Hz (BASS)
 - 6 dB, 20 kHz (TREBLE)
- Signal to Noise Ratio
 - 80 dB (CHAIN IN / AUX IN, Speaker out)
- Speaker Impedance
 - 4 Ω

■ BLUETOOTH Section

- Communication system
 - BLUETOOTH Specification version 5.0
- Frequency band
 - 2.4 GHz (2.402 GHz - 2.480 GHz)
- Modulation method
 - FHSS (Frequency Hopping Spread Spectrum)
- Compatible BLUETOOTH profiles
 - A2DP 1.3.1
 - AVRCP 1.6
 - HFP 1.7
 - HSP 1.2
- Supported Codecs
 - SBC
- Transmission range (A2DP)
 - 20 Hz - 20 kHz (Sampling frequency 44.1 kHz)

- Maximum radio-frequency power transmitted in the frequency band(s)
 - 2400 MHz - 2483.5 MHz: 10 dBm
- Maximum communication range
 - Line of sight approx. 15 m (*)
 - * The actual range will vary depending on factors such as obstacles between devices, magnetic fields around a microwave oven, static electricity, cordless phone, reception sensitivity, antenna's performance, operating system, software application, etc.

■ Supported Media/Format

- Supported USB playback formats
 - MP3

■ General

- Power Supply
 - AC 100 - 240 V, 50/60 Hz
- Power Consumption (Standby mode)
 - SX70: 54 W
 - SX50: 42 W
 - 0.5 W or less (Full Standby mode)
 - 0.5 W or less (BLUETOOTH Wakeup mode)
 - 2 W or less (BLUETOOTH Wakeup & Illumination mode)
- Auto Standby
 - ON (20 min) / OFF
- Speaker Type
 - Bass reflex type
- Speaker Configuration
 - SX70: 5 cm Cone type (Tweeter) / 18 cm Cone type (Woofer)
 - SX50: 5 cm Cone type (Tweeter) / 13 cm Cone type (Woofer)
- Effective Frequency Range
 - SX70: 46 Hz - 20 kHz (Input conditions: Vol max, LINE IN 80 mV)
 - SX50: 59 Hz - 20 kHz (Input conditions: Vol max, LINE IN 104 mV)
 - S.BASS off / Bass ±0 / Treble ±0 / Average sound pressure -10 dB at (300, 400, 500, 600 Hz)

Recommended Frequency Range

SX70: 35 Hz - 20 kHz (Input conditions: Vol max, LINE IN 80 mV)

SX50: 47 Hz - 20 kHz (Input conditions: Vol max, LINE IN 104 mV)

S.BASS off / Bass ± 0 / Treble ± 0 / Average sound pressure -20 dB at (300, 400, 500, 600 Hz)

Dimensions (W × H × D)

SX70: 327 × 682 × 341 mm (12-7/8" × 26-6/7" × 13-3/7")

SX50: 262 × 592 × 281 mm (10-1/3" × 23-1/3" × 11")

Weight (without package)

SX70: 18 kg (39.7 lbs.)

SX50: 12 kg (26.5 lbs.)

■ Others

CHAIN IN: 1 (RCA Jack / Rear)

AUX IN: 1 (ø3.5 mm Stereo mini jack / Top)

CHAIN OUT: 1 (RCA Jack / Rear)

USB: 1 (Ver. 2.0, 5 V/1 A, Rear)

Specifications and features are subject to change without notice.

 → [License and Trademark](#)

Pioneer

SN 29403553C_EN

© 2018 Onkyo & Pioneer Corporation. All rights reserved.

© 2018 Onkyo & Pioneer Corporation. Tous droits de reproduction et de traduction réservés.

"Pioneer" is a trademark of Pioneer Corporation, and is used under license.

F1902-3