



**BEAMZ**  
**MADE**  
**EAZY**

150.782 V1

**WBP912IP PAR**

**QUICK **START** GUIDE**

# DMX CHANNELS

## D001

CHANNEL	FUNCTION	VALUE	DESCRIPTION
1	Colour	000-255	Red, 0-100%
2		000-255	Green, 0-100%
3		000-255	Blue, 0-100%
4		000-255	White, 0-100%
5		000-255	Amber, 0-100%
6		000-255	UV, 0-100%

## A001

CHANNEL	FUNCTION	VALUE	DESCRIPTION
1	Master	000-255	Master dimmer, 0-100%
2	Colour	000-255	Red, 0-100%
3		000-255	Green, 0-100%
4		000-255	Blue, 0-100%
5		000-255	White, 0-100%
6		000-255	Amber, 0-100%
7		000-255	UV, 0-100%
8	Strobe	000-004	No function
		005-255	Strobe, from slow to fast
9	Preset colours	000-007	No function
		008-127	40 preset colours
		128-255	64 factory colours
10	Mode	000-019	No function
		020-127	18 Chases
		128-159	63 Colour fade
		160-191	63 Colour jump
		192-223	63 Colour pulse
		224-255	Sound control
11	Speed	000-255	Speed, from slow to fast
12	Dimmer curve	000-005	Control panel
		006-055	Dimmer curve 0
		056-105	Dimmer curve 1
		106-155	Dimmer curve 2
		156-205	Dimmer curve 3
		206-255	Dimmer curve 4

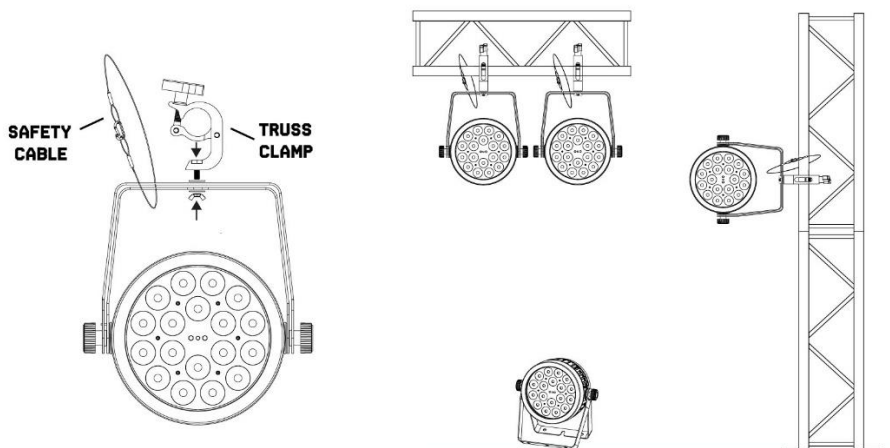

# TIMER FUNCTION

The fixture has a built-in timer function. The fixture can show the pre-programmed preset, colour or chase at certain times and dates.

## STEP 1 Adjust the battery turn of level on between 5-10%

- Press **MENU**
- Select **SETTINGS**, press enter.
- Select **GENERAL**, press enter.
- Select **POWER OFF BATT**, press enter.
- Select percentage between 5 and 10% with the up and down buttons.
- Press **ENTER** to confirm.

## STEP 2 Set the current date and time

- Press **MENU**
- Select **SETTINGS**, press enter.
- Select **DATE/TIME**, press enter.
- Select **DATE**, press enter.
- Select the year with Up/Down buttons, press enter to select the month with Up/Down buttons, press enter to select the day with Up/Down buttons.
- Press **ENTER** to confirm.
- Select **TIME**, press enter.
- Select the hours with Up/Down buttons, press enter to select the minutes with Up/Down buttons, press enter to select the seconds with Up/Down buttons.
- Press **ENTER** to confirm.

## STEP 3 Set automatic turn On time

- Press **MENU**
- Select **SETTINGS**, press enter.
- Select **DATE/TIME**, press enter.
- Select **POWER ON**, press enter.
- Select the hours with Up/Down buttons, press enter to select the minutes with Up/Down buttons, press enter to select the seconds with Up/Down buttons.
- Press **ENTER** to confirm.

## STEP 4 Set automatic turn Off time

- Press **MENU**
- Select **SETTINGS**, press enter.
- Select **DATE/TIME**, press enter.
- Select **POWER OFF**, press enter.
- Select the hours with Up/Down buttons, press enter to select the Minutes with Up/Down buttons, press enter to select the seconds with Up/Down buttons.
- Press **ENTER** to confirm.

## STEP 5 Select the preset, colour or chase program.

- Press **MENU**
- Select **SETTINGS**, press enter.
- Select **GENERAL**, press enter.
- Select **POWER UP**, press enter.
- Select one of the preset, colour or chase program which you want as soon as the fixture starts up.
- Press **ENTER** to confirm.



# BEAMZ

**YOUR FUTURE  
YOUR SKILLS  
YOUR PLATFORM  
YOUR PARTY  
YOUR EVENT**



offers a wide range of high performance lighting equipment and related accessories for the rental, entertainment and architectural lighting markets. BeamZ Pro stands for performance, innovation and value pricing!

