

DENON[®]

DCD-50

COMPACT DISC PLAYER

Owner's Manual

You can print more than one page of a PDF onto a single sheet of paper.

[Front panel](#)[Display](#)[Rear panel](#)[Remote](#)[Index](#)

Accessories	4
Features	5
High quality	5
High performance	5
Part names and functions	6
Front panel	6
Display	8
Rear panel	9
Remote control unit	10

Connections

Connections	13
Installing this unit	14
Installing horizontally	14
Installing vertically	15
Before using the remote control unit	17
Operating range of the remote control unit	18
Connecting a digital device	19
Connecting an analog device	20
Connecting the power cord	21



Playback

Basic operation	23
Turning the power on	23
Switching the display's brightness	23
Playing CDs	24
Playing CDs	24
Playing tracks in a specific order (Program playback)	26
Playing DATA CDs (MP3 and WMA files)	27
Playing files	28

Settings

Other settings	30
Auto Standby	30
Auto Play	31

Tips

Tips	33
Troubleshooting	34

Appendix



Playable media	38
Discs	38
Files	38
Playback order of MP3/WMA files	39
About discs and files	40
Cautions on using media	41
Loading Discs	41
Cautions on Loading Discs	41
How to handle media	42
Cleaning discs	42
Explanation of terms	43
Specifications	44
Index	47



Thank you for purchasing this Denon product. To ensure proper operation, please read this owner's manual carefully before using the product. After reading this manual, be sure to keep it for future reference.

Accessories

Check that the following parts are supplied with the product.

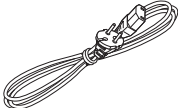
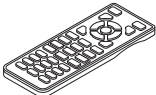
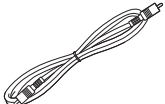
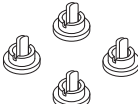
 Quick Start Guide	 CD-ROM (Owner's Manual)	 Safety Instructions	 Power cord
 Remote control unit (RC-1205) (built-in battery)	 Coaxial digital cable	 Caps (silver) (x4)	



Features

High quality

- **A new style of CD player with Denon's trademark quality, containing a high-precision 32-bit D/A converter**
The D/A converter is a key element of sound quality, so this product contains our 32bit/192kHz D/A converter, renowned for its high degree of precision, to bring you the best sound quality possible.
- **This unit can be combined with our high-quality PMA-50 Class D integrated amplifier to achieve a high degree of reproducibility even for extremely weak signals**
Our high-quality PMA-50 Class D integrated amplifier contains Advanced AL32 Processing, Denon's unique analog waveform reproduction technology. Use it with this unit to get the most out of our exceptional sound quality that is both sensitive and powerful to a degree that belies the size of the enclosure.

High performance

- **This new design is the optimal match for our PMA-50 integrated amplifier**
- **Supports vertical installation**
This unit can be placed either vertically or horizontally. The orientation of the display changes automatically to match the orientation in which this unit is placed. The operating mechanism of the CD slot allows smooth and steady opening and closing whether this unit is placed vertically or horizontally.
- **Supports MP3 and WMA file playback**
This unit can play back MP3 and WMA files recorded on CD-R and CD-RW discs. The high-visibility organic EL display can show information such as the track name and artist name when playing back MP3s and WMAs.
- **The auto standby function reduces power consumption**
- **This unit comes with a system remote control that can also operate the PMA-50**



Part names and functions

Front panel

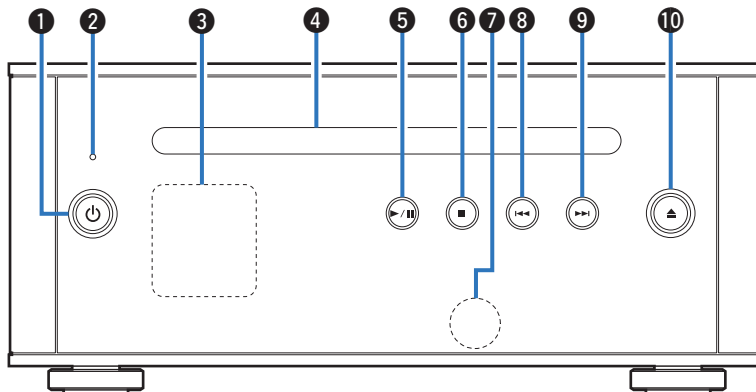

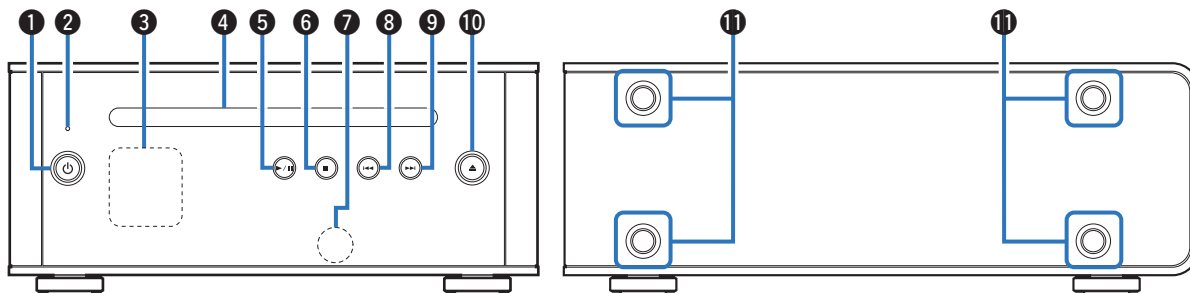

1 Power operation button (⏻)

This turns the power on/to standby. (☞ p. 23)

The power status is indicated as follows.

- Power on: Display lit
- Standby: Display off

2 Protection circuit indicator

This blinks when the protection circuit has operated. (☞ p. 34)

3 Display

This displays various pieces of information. (☞ p. 8)

4 CD slot (☞ p. 41)

5 Play/pause button (▶ / ⏸)

Plays the track/Pauses the track.

6 Stop button (■)

Stops playback.

7 Remote control sensor

This receives signals from the remote control unit. (☞ p. 18)

8 Reverse-skip button (◀◀)

Returns to the start of the currently playing track.

9 Forward-skip button (▶▶)

Plays the next track.

10 CD Eject button (⏏)

Ejects the disc.

11 Installation holes for vertical installation feet

These are used when the unit is installed vertically. (☞ p. 15)



Display

The display automatically rotates to match the installation orientation.

Display sample



Description of icon

- ⌂: random
- ↺: repeat all
- ↻: repeat 1
- 🎵: track
- 📁: folder



Rear panel

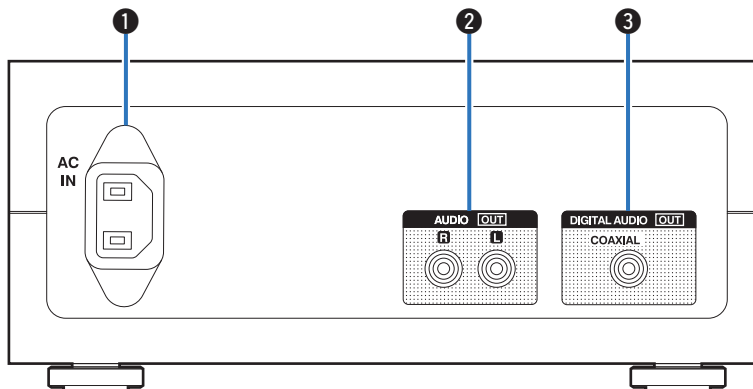

① AC inlet (AC IN)

Used to connect the supplied power cord. (👉 p. 21)

② AUDIO OUT connectors (AUDIO OUT)

Used to connect an amplifier equipped with analog audio input connectors. (👉 p. 20)

③ DIGITAL AUDIO OUT connectors (COAXIAL)

Used to connect an amplifier equipped with digital audio input connector. (👉 p. 19)



Remote control unit

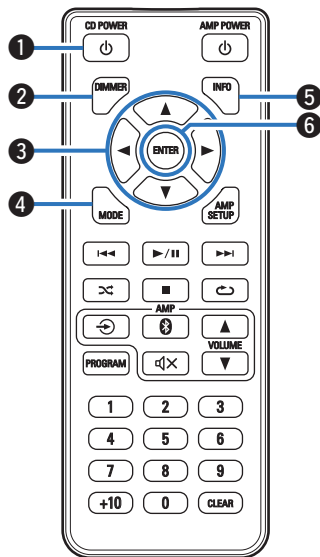

■ Operating this unit

1 Power operation button (⏻)

This turns the power on/to standby.

2 DIMMER button

Adjust the display brightness of this unit. (🔧 p. 23)

3 Cursor buttons (▲▼◀▶)

These select folders or files on a data CD.

4 MODE button

This switches the playback mode. (🔧 p. 27)

5 INFO button

This switches the track information shown in the display during playback. This switches the playback time display.

6 ENTER button

This determines the selection.



- The DIMMER button also controls the Denon's Integrated Amplifier PMA-50, so the PMA-50 can be operated simultaneously with the DCD-50. When the two units have different settings, press and hold in the button for lease 2 seconds to reset them both to the default setting, then make the desired setting.
- The display brightness is set to "Normal" by default.



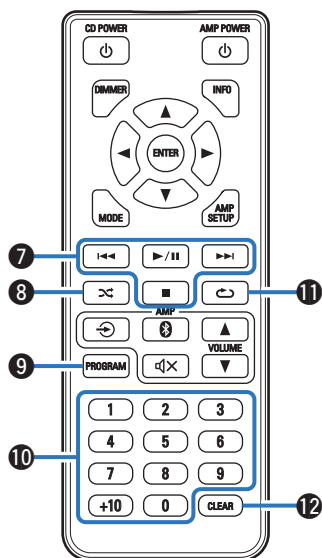

7 System buttons

These perform playback related operations.

- Skip buttons (I◀◀ / ▶▶I)
- Play/pause button (▶ / ||)
- Stop button (■)

8 Random button (⌘)

Switches the random playback.

9 PROGRAM button

This sets program playback. (👉 p. 26)

10 Number buttons (0~9, +10)

These enter numbers into the unit.

11 Repeat button (↺)

Switches the repeat playback.

12 CLEAR button

This clears the program registration.



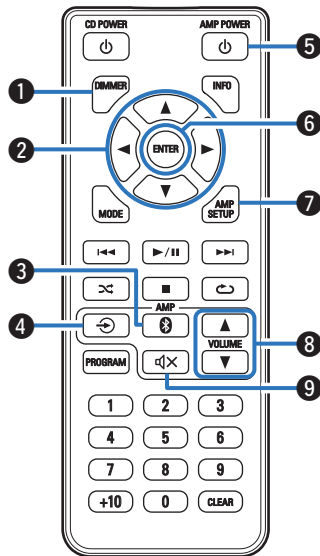

■ Amplifier operations

① DIMMER button

Adjust the display brightness.

② Cursor buttons (▲▼◀▶)

These select menu items.

③ Bluetooth button (⌘)

This switches the input to Bluetooth of PMA-50. This is also pressed during the pairing operation.

④ Input source switching button (↻)

This switches input sources of PMA-50.

⑤ AMP POWER button (⏻)

This turns the power of PMA-50 on/to standby.

⑥ ENTER button

This determines the selection.

⑦ AMP SETUP button

The setting menu is displayed on the display of PMA-50.

⑧ VOLUME button (▲▼)

These adjusts the volume level.

⑨ Mute button (🔇)

This mutes the output audio of PMA-50.



Connections

■ Contents

Installing this unit	14
Connecting a digital device	19
Connecting an analog device	20
Connecting the power cord	21

NOTE

- Do not plug in the power cord until all connections have been completed.
- Do not bundle power cords together with connection cables. Doing so can result in humming or noise.

■ Cables used for connections

Provide necessary cables according to the devices you want to connect.

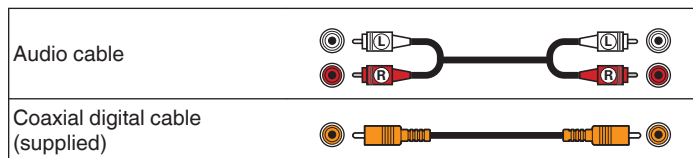

Installing this unit

This unit can be installed in two ways - horizontally or vertically. You can select how to install this unit according to the installation place and your preference.

NOTE

- Choose how you want to install this unit and install it correctly before playing back discs.

Installing horizontally

The feet are initially attached to the unit for horizontal installation.

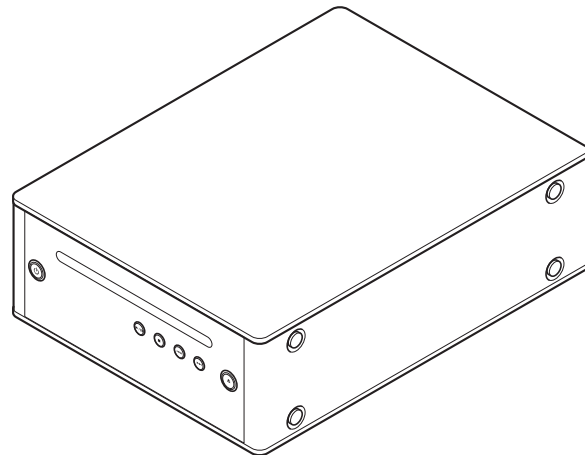

Installing vertically

This orientation is suitable for placing a narrow place.

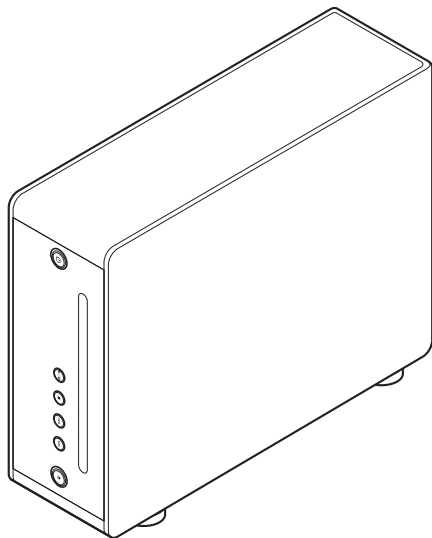

1 Remove the feet.

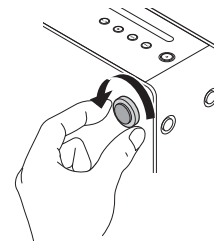

Rotate each of the 4 feet counter-clockwise to remove.

2 Insert the supplied caps (silver) into the holes from which the feet were removed.

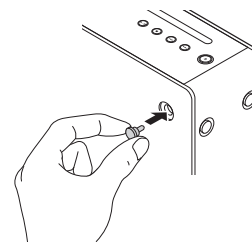

3 Remove the cap (black).

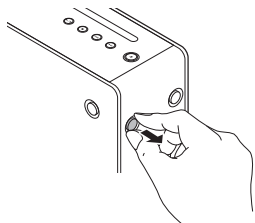

NOTE

- Be careful not to damage your nails when removing the caps. If necessary, use a thin-tipped tool to remove the caps. However, be careful not to damage the unit when using tools.

4 Rotate the removed feet clockwise to attach them.

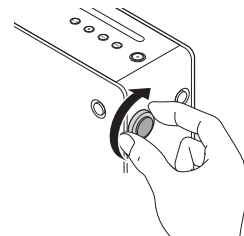

NOTE

- After attaching the feet, adjust the height of the feet as necessary so that the set is stable when installed.



Before using the remote control unit

The remote control unit has a built-in lithium battery.
Pull out the insulation sheet before use.

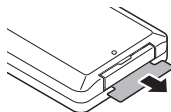

■ Replacing the battery

1. Insert a pointed object into the hole in the battery case and pull out the battery tray.

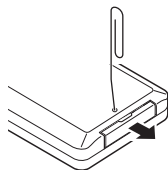

2. Insert the lithium battery correctly into the battery compartment as indicated.
3. Replace the battery case in the original position.

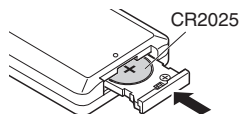

NOTE

- When inserting the lithium battery, be sure to do so in the proper direction, following the ⊕ and ⊖ marks in the battery compartment.
- If the battery should have a leakage, immediately replace and dispose of the battery. In this case, there is a risk of burn when the liquid comes in contact with skins or clothes, so a great care should be taken. If the liquid accidentally comes in contact, wash with tap water and consult a doctor.
- Remove the battery from the remote control unit if it will not be in use for long periods.



Operating range of the remote control unit

Point the remote control unit at the remote sensor when operating it.

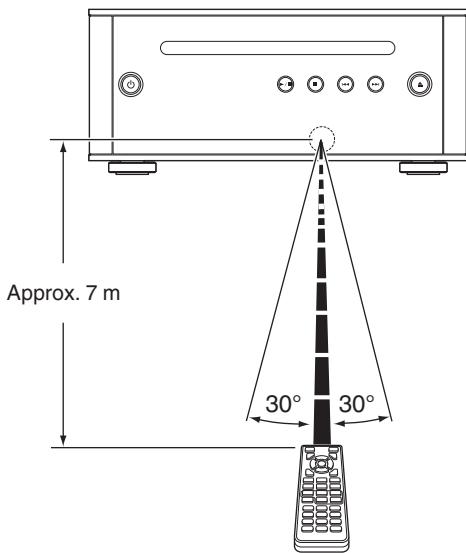

[Horizontal installation]

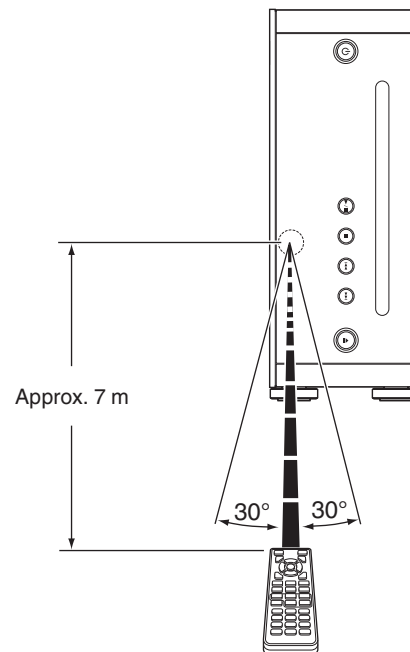

[Vertical installation]

Connecting a digital device

This unit can be connected to an amplifier with digital audio (coaxial) input connector.

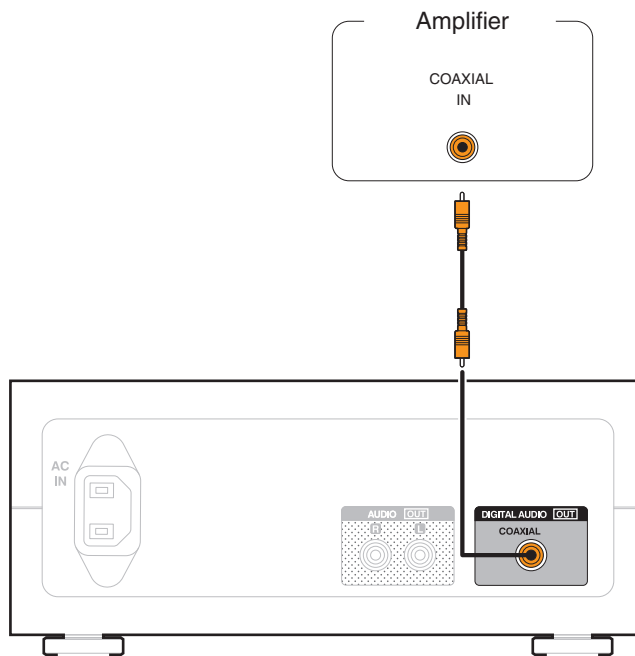

Connecting an analog device

This unit can be connected to an amplifier with analog audio input connectors.

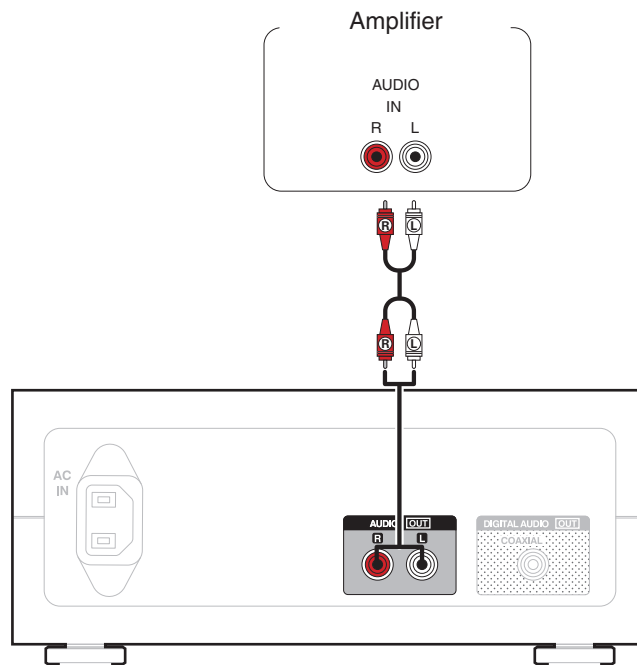

Connecting the power cord

Wait until all connections have been completed before connecting the power cord.

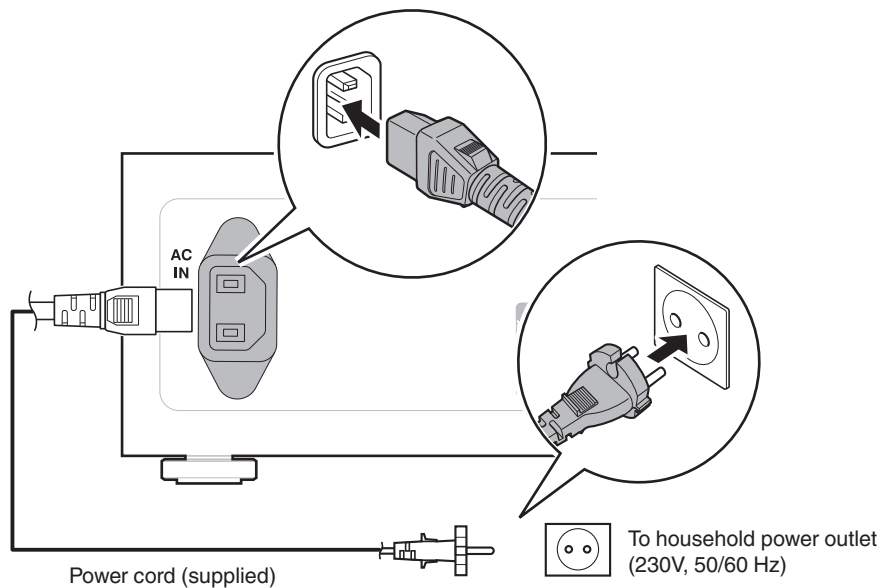

■ Contents

Basic operation	23
Playing CDs	24
Playing DATA CDs (MP3 and WMA files)	27
Other settings	30



Basic operation

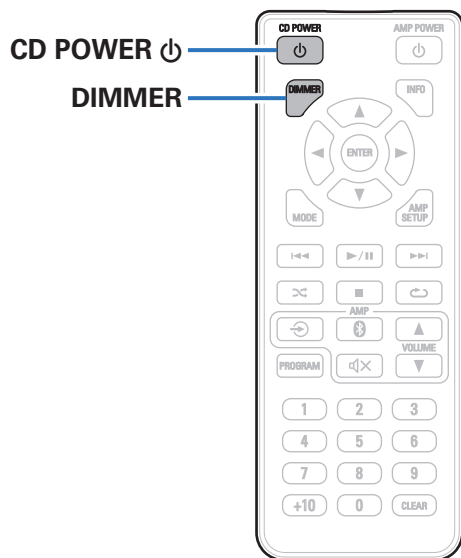

Turning the power on

- 1 Press **CD POWER**  to turn on power to the unit.
Turns the display on.

When power is switched to standby

- 1 Press **CD POWER** .
- Turns the display off.



- You can also press  on the main unit for this operation.

NOTE

- When the power is in the standby mode, some circuits are electrified. Before you go out or travel for a long period of time, disconnect the power cord from the power outlet.

Switching the display's brightness

The brightness of the display can be adjusted to one of three levels.

- 1 Press **DIMMER**.



Playing CDs

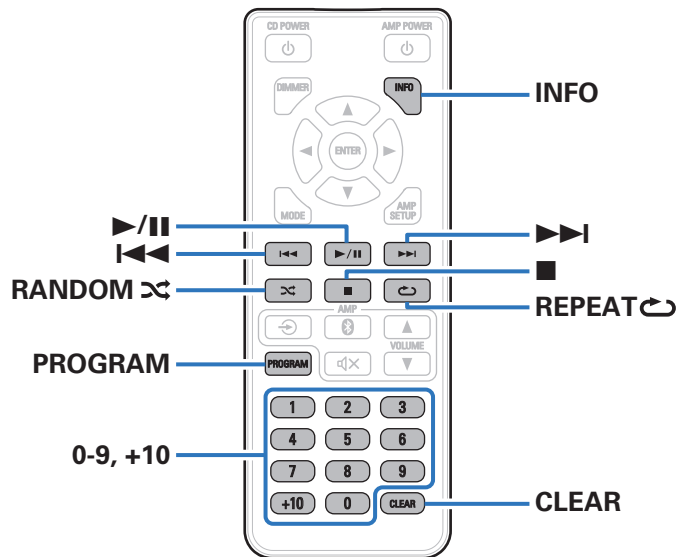

Playing CDs

1 Insert a disc. (🔧 p. 41)

2 Press ▶/||.

The ▶ indicator lights on the display. Playback starts.





NOTE

- Do not place any foreign objects in the disc tray. Doing so could damage the set.
- 8 cm discs cannot be used on this unit. Do not insert 8 cm discs into the CD slot.
- Do not put anything other than a CD to CD slot. Doing so could result in damage.

Eject CDs

1 Press ▲ while playback is stopped.



Operation buttons	Function
	Play/Pause
	Stop
	Skip to previous track / Skip to next track (Press and hold) Fast-reverse / Fast-forward
0 – 9, +10	Select the track
RANDOM 	Random playback
REPEAT 	Repeat playback <ul style="list-style-type: none"> Switching between All-track repeat and Single-track repeat.
INFO	Time display switching <ul style="list-style-type: none"> Track elapsed time, Track remaining time and Total remaining time

■ Playing a specific track (Direct searching)

1 Use 0 – 9 and +10 to select the tracks.

[Example]

Track 4 :

Press number 4 to select track 4.

Track 12 :

Press numbers +10 and 2 consecutively to select track 12.



Playing tracks in a specific order (Program playback)

Up to 25 tracks can be programmed.

1 In the stop mode, press PROGRAM.

“PROG” is displayed on the display.

2 Use 0 – 9 and +10 to select the tracks.



[Example]

To program tracks 3 and 12 to be played in that order, press 3, +10, and 2 one after the other.

3 Press ►/||.

Playback starts in the programmed order.



- When RANDOM  is pressed during program playback, the programmed tracks are played in random order.
- When REPEAT  is pressed during program playback, the tracks are played repeatedly in the programmed order.

NOTE

- The program is cleared when the disc is ejected or the power is turned off.

■ Checking the order of the programmed tracks

In the stop mode, press ►►I.

The tracks are shown in the programmed order in the display each time ►►I is pressed.

■ To clear the last track programmed

In the stop mode, press CLEAR.

To clear the last track programmed.

The last track programmed is cleared each time the button is pressed.

■ Clearing the all programmed track

In the stop mode, press PROGRAM.



Playing DATA CDs (MP3 and WMA files)

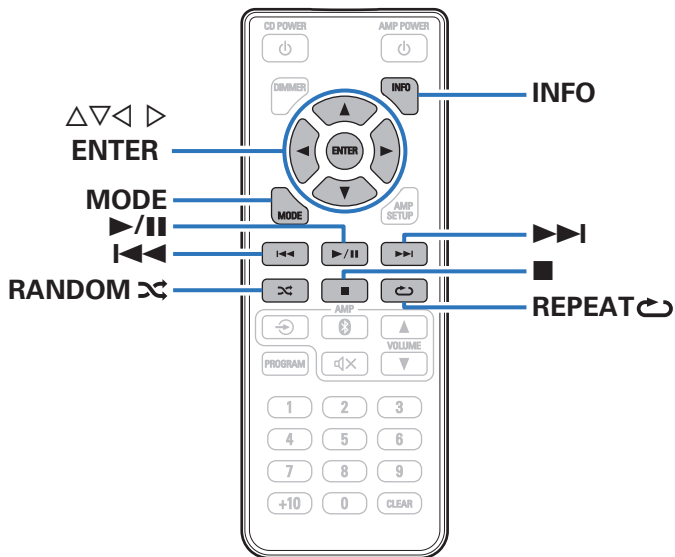

- This section explains how to playback MP3 and WMA files that are recorded onto a CD-R or CD-RW. For details on how to playback files recorded onto media other than CD-R or CD-RW, see the following sections.
- There are many music distribution sites on the Internet allowing you to download music files in MP3 or WMA (Windows Media® Audio) format. The music (files) downloaded from such sites can be stored on CD-R or CD-RW discs and played on this unit.

“Windows Media” and “Windows” are the trademarks or registered trademarks of Microsoft Corporation in the United States and other countries.



Playing files

1 Insert a CD-R or CD-RW containing MP3 or WMA format music files into the CD slot. (☞ p. 41)

2 Press **MODE** to select the folder mode or all mode.

About the display

- When "Folder mode" is selected

"■" indicator lights.

All the files in the selected folder are played.

- When "All mode" is selected

"■" indicator turns off.



After the selected folder and files are played, all the files in all the folders are played.

3 Use $\Delta \nabla$ to select the folder to be played.

4 Use $\triangleleft \triangleright$ to select the file to be played.

5 Press **▶**.

Playback starts.

Operation buttons	Function
▶ / 	Play/Pause
■	Stop
⏮ ⏭	Skip to previous track / Skip to next track (Press and hold) Fast-reverse / Fast-forward
△ ▽	Folder select
◀ ▶	File select
0 - 9, +10	Select the track
MODE	Switch to Folder playback mode <ul style="list-style-type: none"> All the files in the selected folder are played.
RANDOM 	Random playback
REPEAT 	Repeat playback <ul style="list-style-type: none"> Switching between All-track repeat and Single-track repeat.



- The folder and file numbers are set automatically when the disc is loaded.



NOTE

- Programmed playback is not possible with MP3/WMA discs.
- Copyright-protected files cannot be played.

(The “Unsupported” is displayed.)

Note that depending on the software used for burning and other conditions, some files may not play or display correctly.

■ Playable files (Extension) p. 38

■ To switch the folder or file during playback

- Folder

Use $\Delta \nabla$ to select the folder, then press ENTER.

- Files

Use $\triangleleft \triangleright$ to select the file, then press ENTER.

Also use $\blacktriangleleft\blacktriangleleft$, $\blacktriangleright\blacktriangleright$ to select the file, or use 0 – 9, +10 to select the file number.

■ Switching the display

During playback, press INFO.

- Switching between the title name, artist name and album name.
- The player can display the following characters:

ABCDEFGHIJKLMNOPQRSTUVWXYZ

abcdefghijklmnopqrstuvwxyz

0123456789

! " # \$ % & ; < > ? @ \ [] _ ` | { } ~ ^ ' () * + , - . / = (space)

If there is no title, the file name is displayed instead.



Other settings

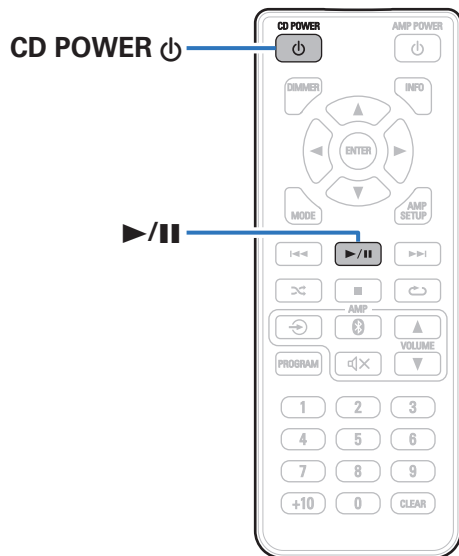

Auto Standby

Sets whether to automatically switch the unit to the standby mode when the unit remains in the stop mode for more than 30 minutes.

1 When this unit in the power on, press and hold  for 5 seconds.

On
(Default): Enable Auto Standby mode.

Off: Disable Auto Standby mode.



- Press and hold  to turn this setting ON or OFF.
 - When the setting is On, the display shows "Auto Standby On".
 - When the setting is Off, the display shows "Auto Standby Off".



Auto Play

Set whether to automatically start playback after inserting a disc.

1 When this unit in the power on, press and hold ►/|| for 5 seconds.

On:	Playback starts automatically.
Off (Default):	Playback does not start automatically.



- Press and hold ►/|| to turn this setting ON or OFF.
 - When the setting is On, the display shows "Auto Play On".
 - When the setting is Off, the display shows "Auto Play Off".
- Playback starts automatically when Auto Play is set to On and the power is turned on when a disc is already inserted.



■ Contents

Tips

I want to playback just the specified folder	33
I want to start playback automatically after inserting a disc	33
I want to play back music with a single operation from the standby state	33

Troubleshooting

Power does not turn on / Power is turned off	34
LED is flashing	34
Operations cannot be performed through the remote control unit	35
No sound comes out	36
Cannot playback CDs	36
Cannot eject the disc	37
File names or tag data are not displayed correctly	37



Tips

I want to playback just the specified folder

- The MODE button to set the playback range to “Folder mode”. (👉 p. 28)

I want to start playback automatically after inserting a disc

- Turn Auto Play on. (👉 p. 31)

I want to play back music with a single operation from the standby state

- Press the ▶/⏸ button on this unit or the remote control unit to turn on the power and start playback.



Troubleshooting

If a problem should arise, first check the following.

1. **Are the connections correct?**
2. **Is the set being operated as described in the owner's manual?**
3. **Are the other devices operating properly?**

If this unit does not operate properly, check the items listed in the table below.

Should the problem persist, there may be a malfunction. In this case, disconnect the power immediately and contact your store of purchase.

■ Power does not turn on / Power is turned off

Symptom	Cause / Solution	Page
Power is not turned on.	<ul style="list-style-type: none"> • Check whether the power plug is correctly inserted into the power outlet. 	<u>21</u>
Power automatically turns off.	<ul style="list-style-type: none"> • The Auto Standby mode is set. The Auto Standby mode switches the unit to standby mode when the unit is not operated for approximately 30 minutes. To disable the Auto Standby mode, press and hold the power operation button (⏻) for more than 5 seconds when the Auto Standby mode is enabled. 	<u>30</u>

■ LED is flashing

Symptom	Cause / Solution	Page
Flashing red.	<ul style="list-style-type: none"> • A circuit in the unit has malfunctioned. Disconnect the power and contact the repair center. 	—



■ Operations cannot be performed through the remote control unit

Symptom	Cause / Solution	Page
Operations cannot be performed through the remote control unit.	• Batteries are worn out. Replace with new batteries.	17
	• Operate the remote control unit within a distance of about 7 m from this unit and at an angle of within 30°.	18
	• Remove any obstacle between this unit and the remote control unit.	—
	• Insert the batteries in the proper direction, checking the [Thread-Plus] and [Tread-Minus] marks.	17
	• The set's remote control sensor is exposed to strong light (direct sunlight, inverter type fluorescent bulb light, etc.). Move the set to a place in which the remote control sensor will not be exposed to strong light.	—
	• When using a 3D video device, the remote control unit of this unit may not function due to effects of infrared communications between units (such as TV and glasses for 3D viewing). In this case, adjust the direction of units with the 3D communications function and their distance to ensure they do not affect operations from the remote control unit of this unit.	—



■ No sound comes out

Symptom	Cause / Solution	Page
No sound is produced. Or sound is distorted.	• Check the connections for all devices.	13
	• Insert connection cables all the way in.	—
	• Check that input connectors and output connectors are not reversely connected.	—
	• Check cables for damage.	—
	• Check the amplifier's functions and controls and adjust as necessary.	—

■ Cannot playback CDs

Symptom	Cause / Solution	Page
Cannot playback when the play button is pressed, or cannot correctly play back a specific part of the disc.	• The CD is dirty or scratched. Either clean the CD, or insert a different CD.	42
Cannot playback CD-R/CD-RW.	• CDs cannot be played back unless they have been finalized. Use a finalized disc.	38
	• This may be caused by poor recording conditions, or the disc itself may be of poor quality. Use a correctly recorded disc.	—
	• The DATA CD playback function of this unit only supports playback of MP3 and WMA files.	38
"Unsupported" is displayed.	• The disc is loaded upside-down.	38
	• The disc that cannot be played is loaded.	38



■ Cannot eject the disc

Symptom	Cause / Solution	Page
The disc is not ejected when the Eject button is pressed.	• Press and hold the ▲ button for 5 seconds or more.	—
	• This unit is malfunctioning. Contact our repairs service.	—



■ File names or tag data are not displayed correctly

Symptom	Cause / Solution	Page
The file names are not displayed properly (“...”, etc.).	• Characters that cannot be displayed are used. This is not a malfunction. On this unit, characters that cannot be displayed are replaced with a “.” (period).	—



Playable media

Discs

Playable media	
CD	
CD-R	
CD-RW	

NOTE

- Some discs and some recording formats may not be playable.
- Non-finalized discs cannot be played.

Files

CD-R and CD-RW discs created in the format described below can be played.

■ Writing software format

ISO9660 level 1, 2

Expansion format (Juliet.Romeo)

■ When written in other formats, it may not be possible to play the disc properly.

Maximum number of playable files and folders

Number of folders : 255

Number of files : 255

■ Tag data

ID3-TAG (Ver.1.x and 2.x)

WMA-TAG

(The title, artist, and album tag data are supported)



Playable files (Extension)	File specification
MP3 (.mp3)	• Sampling frequency : 32 / 44.1 / 48 kHz
	• Bit rate : 32 kbps to 320 kbps
	• File format : MPEG1 Audio Layer 3
WMA (.wma)	• Sampling frequency : 32 / 44.1 / 48 kHz
	• Bit rate : 64 kbps to 192 kbps
	• File format : Windows Media Audio

NOTE

- Be sure to give files the extension “.mp3” or “.wma”. Files with any other extensions or files with no extensions cannot be played.
- Recordings you have made should only be used for your personal enjoyment, and as per copyright laws may not be used in other ways without permission of the copyright holder.

Playback order of MP3/WMA files

When there are multiple folders containing MP3/WMA files, the playback order of folders is automatically set when this unit reads the media. The files in each folder are played back in the order in which the files were recorded on the media, from the oldest date and time.

CD-R/CD-RW

For playback of files on CD-R or CD-RW, files in all folders on the first layer are played first, next on the second layer, then next on the third layer, and so on in this order.



- The playback order displayed on a PC may differ from the actual playback order.
- The playback order with a CD-R/CD-RW may differ, depending on the writing software.



About discs and files

Files, such as MP3/WMA etc., recorded on CD-R/-RW are divided into large segments (folders) and small segments (files). Files are stored in folders, and folders can be placed for storage in a hierarchy. The unit can recognize up to 8 levels of folders.

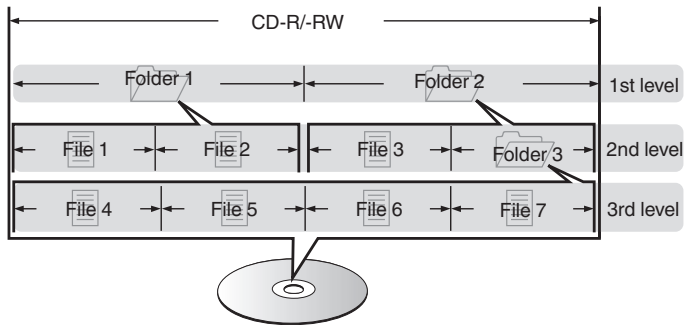

When writing MP3/WMA etc. files on a CD-R/-RW disc, set the writing software's format to "ISO9660". The files may not play properly if they are recorded in other formats. For details, refer to the instructions of your writing software.



Cautions on using media

Loading Discs

- When the set is installed horizontally, insert the disc with the label side up.
- When the set is installed vertically, insert the disc with the label facing right.
- Insert the disc into the CD slot slowly. Release your hand once the disc is drawn in.

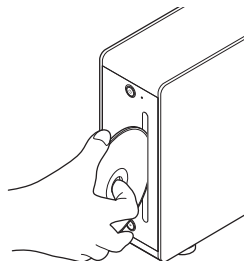
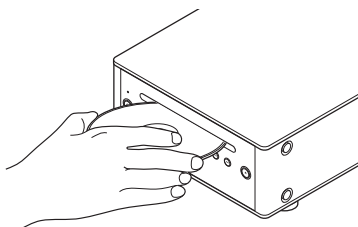

- When no disc is loaded, "No Disc" is displayed.
- When the disc is loaded upside-down, "Unsupported" is displayed.
- When the disc's information could not be read properly, "Unsupported" is displayed.

Cautions on Loading Discs

- 8 cm discs cannot be used on this player. Do not insert 8 cm discs into the CD slot.
- Do not use an 8 cm disc adapter.
- Only load one disc at a time. Loading two or more discs can damage the unit or scratch the discs.
- Do not use cracked or warped discs or discs that have been repaired with adhesive, etc.
- Do not use discs on which the sticky part of cellophane tape or labels is exposed or on which there are traces of where labels have been removed. Such discs can get caught inside the player and damage it.



How to handle media

- Do not get fingerprints, oil or dirt on discs.
- Take special care not to scratch discs when removing them from their cases.
- Do not bend or heat discs.
- Do not enlarge the hole in the center.
- Do not write on the labeled (printed) surface with ball-point pens, pencils, etc., or stick new labels on discs.
- Condensation may form on discs if they are moved suddenly from a cold place (outdoors for example) to a warm place, but do not try to dry discs with a hairdryer, etc.
- Do not store discs in the following places:
 1. Places exposed to direct sunlight for long periods of time
 2. Dusty or humid places
 3. Places exposed to heat from heaters, etc.

Cleaning discs

- If there are fingerprints or dirt on a disc, wipe them off before using the disc.
- Use a commercially available disc cleaning set or a soft cloth to clean discs.



Gently wipe the disc from the inside towards the outside.

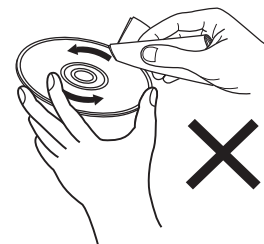

Do not wipe with a circular motion.

NOTE

- Do not use record spray, antistatic agents, benzene, thinner or other solvents.



Explanation of terms

MP3 (MPEG Audio Layer-3)

This is an internationally standardized audio data compression scheme, using the “MPEG-1” video compression standard. It compresses the data volume to about one eleventh its original size while maintaining sound quality equivalent to a music CD.

WMA (Windows Media Audio)

This is audio compression technology developed by Microsoft Corporation.

WMA data can be encoded using Windows Media® Player.

To encode WMA files, only use applications authorized by Microsoft Corporation. If you use an unauthorized application, the file may not work properly.

Sampling frequency

Sampling involves taking a reading of a sound wave (analog signal) at regular intervals and expressing the height of the wave at each reading in digitized format (producing a digital signal).

The number of readings taken in one second is called the “sampling frequency”. The larger the value, the closer the reproduced sound is to the original.

Dynamic range

The difference between the maximum undistorted sound level and the minimum discernible level above the noise emitted by the device.

Bit rate

This is the amount of audio data recorded on a disc that is read in one second.

Finalizing

This process enables CDs recorded with a CD recorder or drive to be played by other players.

Linear PCM

This is an uncompressed PCM (Pulse Code Modulation) signal. Unlike lossy compression audio sources such as MP3, no audio quality or dynamic range deteriorates.



Specifications

■ Audio performance

• Analog output

Channels:	2-channels
Playable frequency range:	2 Hz – 20 kHz
Playable frequency response:	20 – 20 kHz ($\pm 1\%$)
S/N:	105 dB
Dynamic range:	100 dB
Channel Separation:	100 dB
Harmonic distortion:	0.004 % (1 kHz)
Wow & flutter:	Crystal accuracy

• Output level

Signal type:	2 V RMS stereo
---------------------	----------------

• Digital output

Coaxial:	0.5 V _{p-p} / 75 Ω /ohms
-----------------	--

• Optical readout system

Laser:	AlGaAs
Wave length:	780 nm
Signal type:	16-bit linear PCM
Sampling frequency:	44.1 kHz



■ General

Power supply:	AC 230 V, 50/60 Hz
Power consumption:	10 W
Power consumption in standby mode:	0.4 W or less
Operating temperatures:	+5 °C - +35 °C
Operating humidity:	5 – 90 % (without dew)

For the purpose of improvement, the specifications and design are subject to change without notice.



■ Dimensions (Unit : mm)

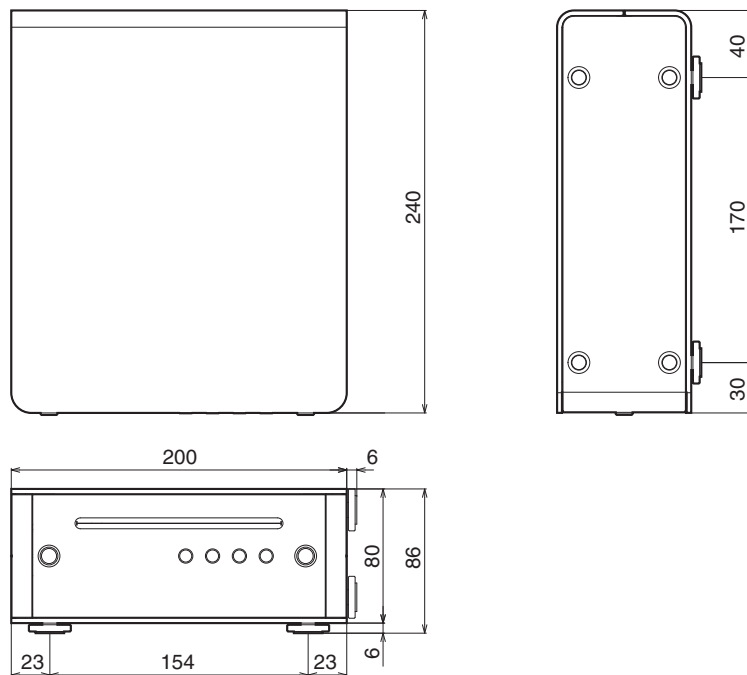

■ Weight: 2.4 kg

Index

A

Analog device	20
Auto Play	31
Auto Standby	30

C

CDs	24
-----------	----

D

DATA CDs	27
Digital device	19
Dimmer	23
Display	8

F

Front panel	6
-------------------	---

P

Program playback	26
------------------------	----

R

Random playback	24, 27
Rear panel	9
Remote control unit	10
Repeat playback	24, 27





DENON®

www.denon.com

3520 10398 00AD

Copyright ©2015 D&M Holdings Inc. All Rights Reserved.