



marantz

CD Player
CD6007

Owner's Manual

Front panel

Display

Rear panel

Remote

Index



Accessories	4
Inserting the batteries	5
Operating range of the remote control unit	5
Part names and functions	6
Front panel	6
Display	9
Rear panel	10
Remote control unit	11

Connections

Connecting an amplifier	18
Connecting to a device with digital audio input connectors	19
Connecting a USB memory device to the USB port	20
Connecting devices with remote control connectors	21
Connection	21
Setting	21
Connecting the timer device	22
Connecting the power cord	23

Playback

Basic operation	25
Turning the power on	25
Switching the power to standby	25
Selecting the playback media mode	26
Switching the display's brightness	26
Playing CDs	27
Playing CDs	27
Playing tracks in a specific order (Program playback)	29
Playing DATA CDs	30
Playing files	31
Playing a USB memory device	33
Playing files stored on USB memory devices	34



Settings

Menu map	36
Menu operation	37
H/P AMP GAIN	38
Filter	38
Digital Out	39
Timer Play	39
Auto-Standby	40

Tips

Tips	42
Troubleshooting	43
Power does not turn on / Power is turned off	44
Operations cannot be performed through the remote control unit	45
Display on this unit shows nothing	45
No sound comes out	46
Sound is interrupted or noise occurs	46
Desired sound does not come out	46
USB memory devices cannot be played back	47
Cannot playback Discs	48

Appendix





Playing back Discs	49
Files	49
Playing back a USB memory devices	51
Playback order of music files	52
About discs and files	53
Cautions on using media	54
Loading discs	54
How to handle media	55
Cleaning discs	55
Explanation of terms	56
Trademark information	58
Specifications	59
Index	62

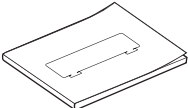

Thank you for purchasing this Marantz product. To ensure proper operation, please read this owner's manual carefully before using the product. After reading this manual, be sure to keep it for future reference.

Accessories

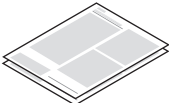
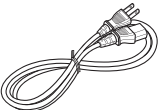
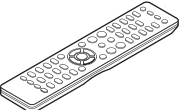
Check that the following parts are supplied with the product.

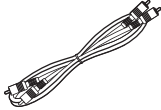
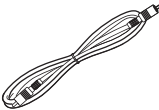
 <p>Quick Start Guide</p>	 <p>CD-ROM (Owner's Manual)</p>	 <p>Safety Instructions</p>	 <p>Warranty (for USA/for CANADA)</p>
 <p>Power cord</p>	 <p>Remote control unit (RC004PMCD)</p>	 <p>R03/AAA batteries</p>	 <p>Audio cable</p>
 <p>Remote connector cable</p>			



Inserting the batteries

- 1 Remove the rear lid in the direction of the arrow and remove it.

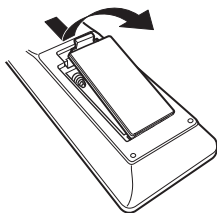

- 2 Insert two batteries correctly into the battery compartment as indicated.

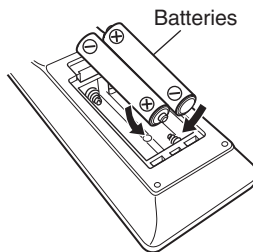

- 3 Put the rear lid back on.

NOTE

- To prevent damage or leakage of battery fluid:
 - Do not use a new battery together with an old one.
 - Do not use two different types of batteries.
- Remove the batteries from the remote control unit if it will not be in use for long periods.
- If the battery fluid should leak, carefully wipe the fluid off the inside of the battery compartment and insert new batteries.

Operating range of the remote control unit

Point the remote control unit at the remote sensor when operating it.

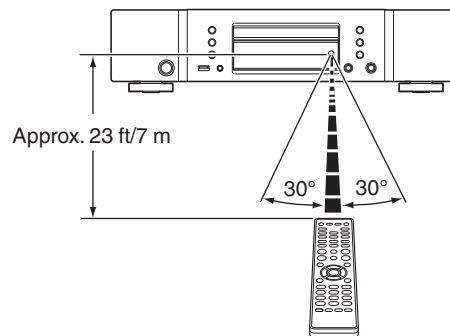

Part names and functions

Front panel

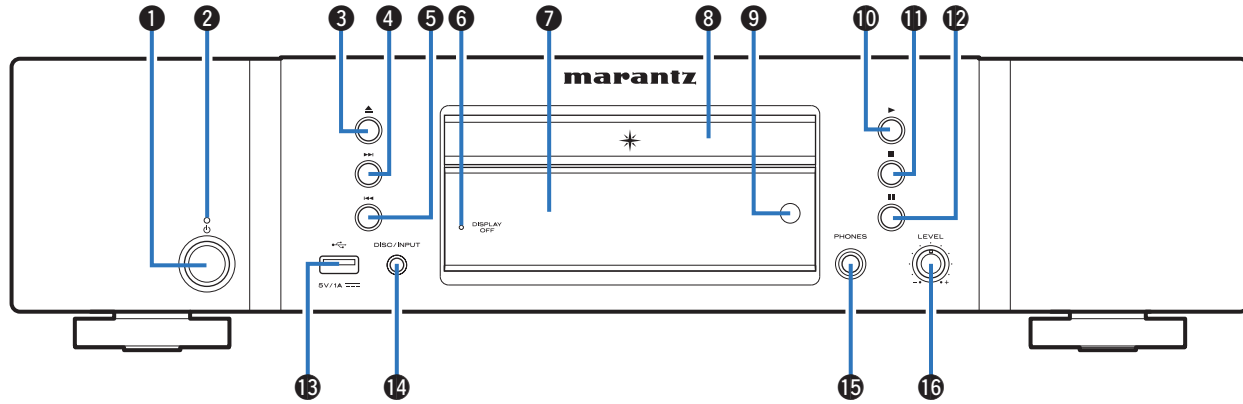

For details, see the next page.



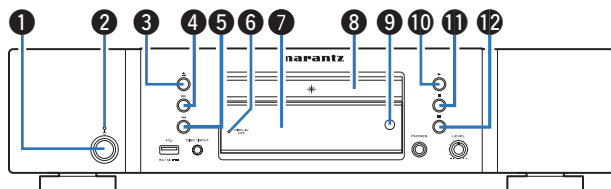

1 Power operation button (⏻)

This turns the power on/off (standby). (☞ p. 25)

2 Power indicator

This is lit as follows according to the power status:

- Power on : Off
- Standby : Red

3 Disc tray open/close button (⏏)

Opens and closes the disc tray. (☞ p. 27)

4 Forward-skip button (▶▶)

Plays the next track. Press and hold to fast-forward the track.

5 Reverse-skip button (◀◀)

Returns to the start of the currently playing track. Press and hold to fast-reverse the track.

6 DISPLAY OFF indicator

Lights when the display is off. (☞ p. 26)

7 Display

Various information is displayed here. (☞ p. 9)

8 Disc tray

Used to insert a disc.

9 Remote control sensor

This receives signals from the remote control unit. (☞ p. 5)

10 Play button (▶)

Playback starts.

11 Stop button (■)

Stops playback.

12 Pause button (⏸)

Pauses playback.

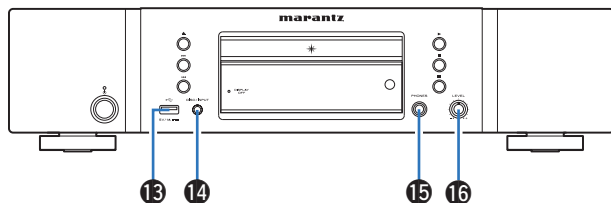

**13 USB port**

This is used to connect USB storages (such as USB memory devices).
( p. 20)

14 DISC/INPUT button

Used to select the playback source. ( p. 26)

15 Headphones jack (PHONES)

Used to connect headphones.

16 Headphone volume control knob (LEVEL)

Adjusts the headphone volume.

NOTE

- To prevent hearing loss, do not raise the volume level excessively when using headphones.



Display

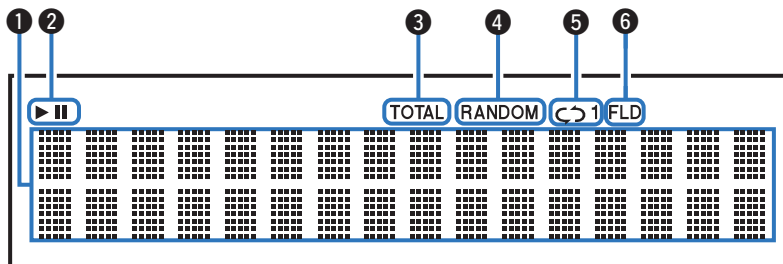

❶ Information display

Displays various information or playback elapsed time and so on of the disc.

❷ Playback mode indicators

▶ : Lights up during playback.

|| : Lights up during pause.

❸ TOTAL indicator

Lights when the total number of tracks and total time of the CD are displayed.

❹ RANDOM indicator

Lights during random playback.

❺ Repeat mode indicators

Lights to match the repeat mode settings.

❻ Folder mode indicator

Lights up when the folder mode is set in the CD-R/CD-RW playback range. (🔗 p. 32)



Rear panel

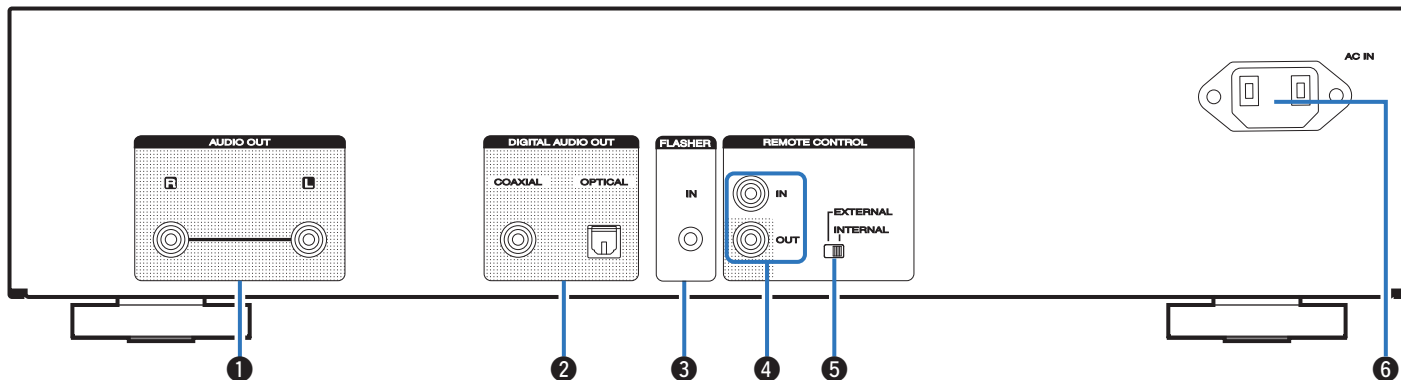

1 AUDIO OUT connectors

Used to connect devices equipped with analog audio inputs connectors or an external power amplifier. (☞ p. 18)

2 DIGITAL AUDIO OUT connectors (COAXIAL/OPTICAL)

Used to connect an Amplifier or D/A converter that has a digital input connectors. (☞ p. 19)

3 FLASHER IN jack

Used when using a control BOX or other such control devices to control this unit.

4 REMOTE CONTROL connectors

Used to connect to a Marantz amplifier that is compatible with the remote control function. (☞ p. 21)

5 EXTERNAL/INTERNAL switch

Turn this switch to "EXTERNAL" to operate the unit by pointing the remote control at the amplifier connected to this unit using the remote control connection. (☞ p. 21)

6 AC inlet (AC IN)

Used to connect the power cord. (☞ p. 23)



Remote control unit

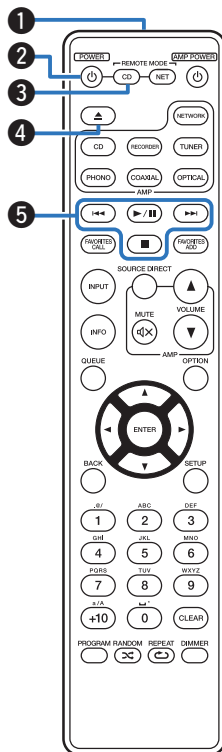

The remote control provided with this unit can control a network audio player in addition to a Marantz amplifier.

- “Amplifier operations” (📖 p. 14)
- “Network audio player operations” (📖 p. 15)

■ Operating this unit

To operate CD player, press REMOTE MODE CD button to switch the remote control to the CD player operation mode.

1 Remote control signal transmitter

This transmits signals from the remote control unit. (📖 p. 5)

2 Power operation button (POWER ⏻)

This turns the power on/off (standby). (📖 p. 25)

3 Remote mode select button (REMOTE MODE CD)

This switches the remote control operating mode to CD player.

4 Disc tray open/close button (▲)

Opens and closes the disc tray. (📖 p. 27)

5 System buttons

These perform playback related operations.



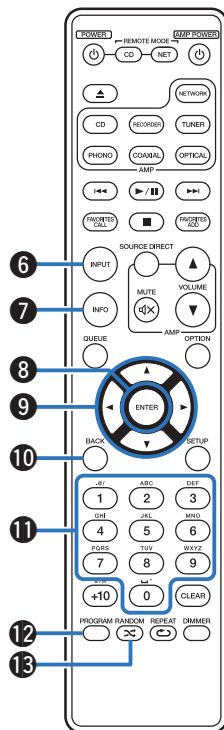

6 Media mode select button (INPUT)

Used to select the playback source. (👉 p. 26)

7 Information button (INFO)

This switches the track information shown in the display during playback.

8 ENTER button

This determines the selection.

9 Cursor buttons (Δ▽◀▶)

These select items.

10 BACK button

Returns to the previous item.

11 Number buttons (0 – 9)

These enter numbers into the unit.

12 PROGRAM button

This sets program playback. (👉 p. 29)

13 RANDOM button (🎲)

Switches the random playback.



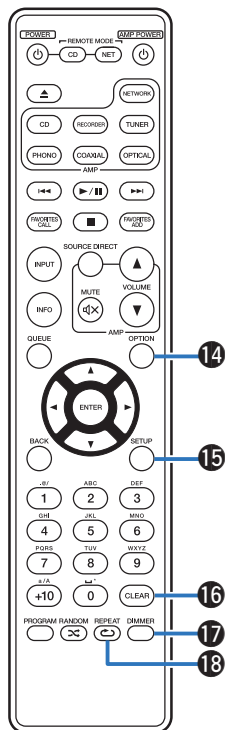

14 OPTION button

Selects the playback range of the data CD. (☞ p. 32)

15 SETUP button

This displays the setting menu on the display. (☞ p. 37)

16 CLEAR button

This clears the program registration. (☞ p. 29)

17 DIMMER button

This switches the brightness of the display. (☞ p. 26)

18 REPEAT button (↺)

Switches to the repeat playback.



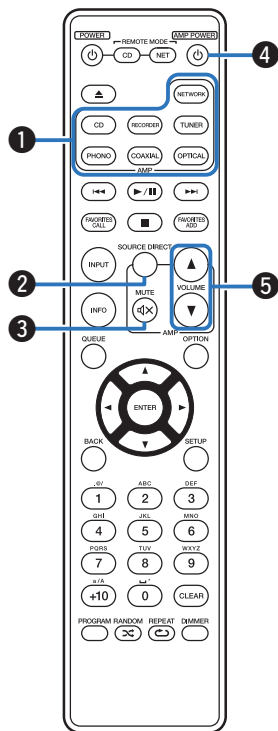

■ Amplifier operations

A Marantz amplifier can be operated.

- ① Input source select buttons
- ② SOURCE DIRECT button
- ③ MUTE button (🔇)
- ④ Power operation button (AMP POWER ⏻)
- ⑤ VOLUME buttons (▲▼)



- The remote control may not operate some products.



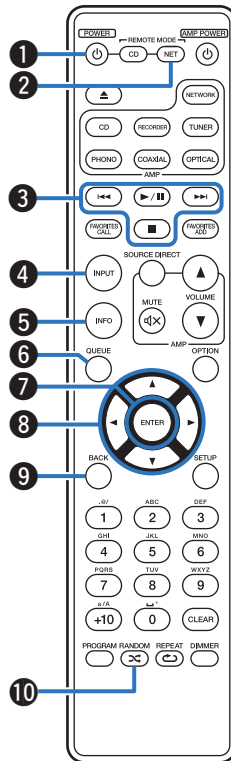

Network audio player operations

You can operate a Marantz network audio player.

To operate a Marantz network audio player, press the REMOTE MODE NET button to switch the remote control to the network audio player operation mode.

- 1 Power operation button (POWER ϕ)
- 2 Remote mode select button (REMOTE MODE NET)
- 3 System buttons
- 4 Media mode select button (INPUT)
- 5 Information button (INFO)
- 6 QUEUE button
- 7 ENTER button
- 8 Cursor buttons ($\Delta \nabla \triangleleft \triangleright$)
- 9 BACK button
- 10 RANDOM button (∞)



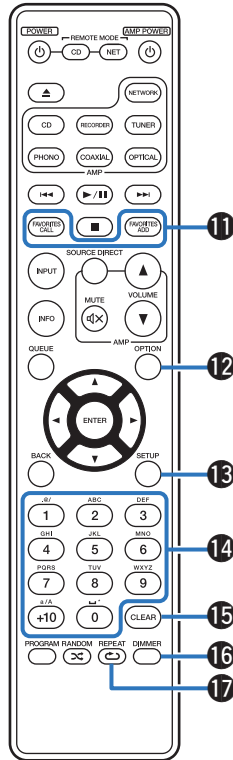

- 11 FAVORITES ADD / CALL buttons
- 12 OPTION button
- 13 SETUP button
- 14 Number/letter buttons (0 – 9, +10)
- 15 CLEAR button
- 16 DIMMER button
- 17 REPEAT button (↺)



- The remote control may not operate some products.



■ Contents





Connecting an amplifier	18
Connecting to a device with digital audio input connectors	19
Connecting a USB memory device to the USB port	20
Connecting devices with remote control connectors	21
Connecting the timer device	22
Connecting the power cord	23

NOTE

- Do not plug in the power cord until all connections have been completed.
- Do not bundle power cords together with connection cables. Doing so can result in humming or noise.

■ Cables used for connections

Provide necessary cables according to the devices you want to connect.

Audio cable (supplied)	
Remote connector cable (supplied)	
Optical cable	
Coaxial digital cable	



Connecting an amplifier

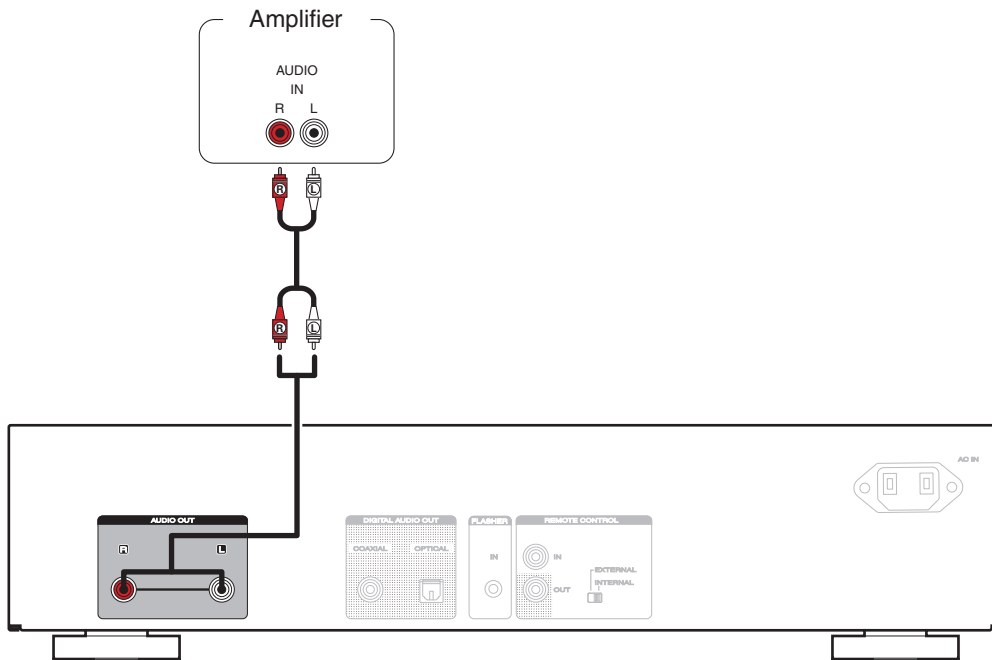

Connecting to a device with digital audio input connectors

You can enjoy digital audio playback by connecting an amplifier or D/A converter that has a digital audio connector to this unit.

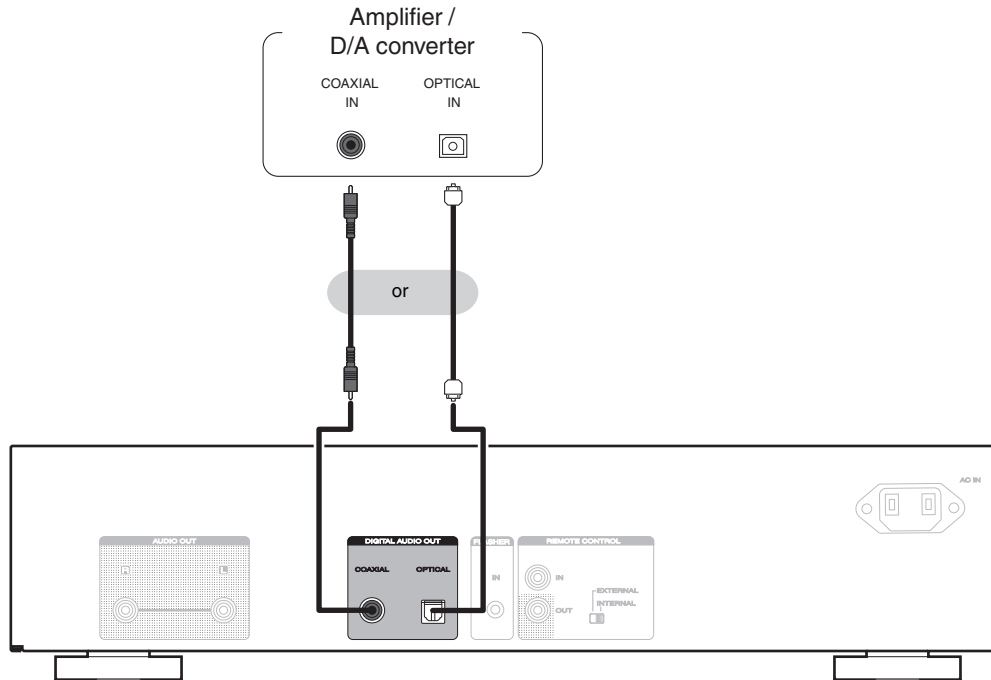

Connecting a USB memory device to the USB port

For operating instructions see “Playing a USB memory device”. (📖 p. 33)

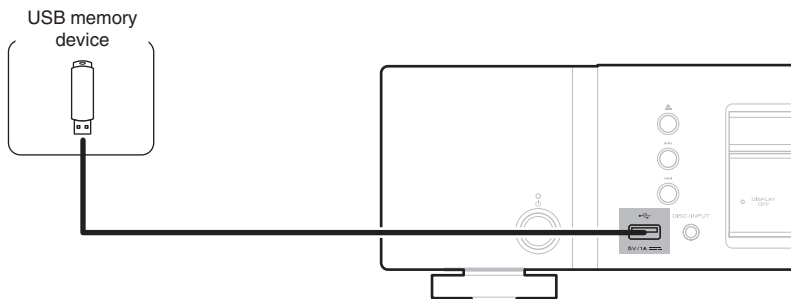

- Marantz does not guarantee that all USB memory devices will operate or receive power. When using a portable USB hard disk drive (HDD) which came with an AC adapter, use that device's supplied AC adapter.

NOTE

- USB memory devices will not work via a USB hub.
- It is not possible to use this unit by connecting the unit's USB port to a PC via a USB cable.
- Do not use an extension cable when connecting a USB memory device. This may cause radio interference with other devices.



Connecting devices with remote control connectors

When you use this unit connected to a Marantz amplifier, this unit receives operation signals sent from the amplifier and operates accordingly. Next, configure the “Connection” and “Setting”.

Connection

Use the supplied remote connector cable to connect the REMOTE CONTROL IN connector of this unit to REMOTE CONTROL OUT connector of the amplifier.

Setting

Turn the EXTERNAL/INTERNAL switch on the unit to “EXTERNAL”.

- This setting will disable remote sensor reception of this unit.
- To operate the unit, point the remote control at the remote sensor of the amplifier.



- To use this unit by itself without connecting an amplifier, turn the switch to “INTERNAL”.

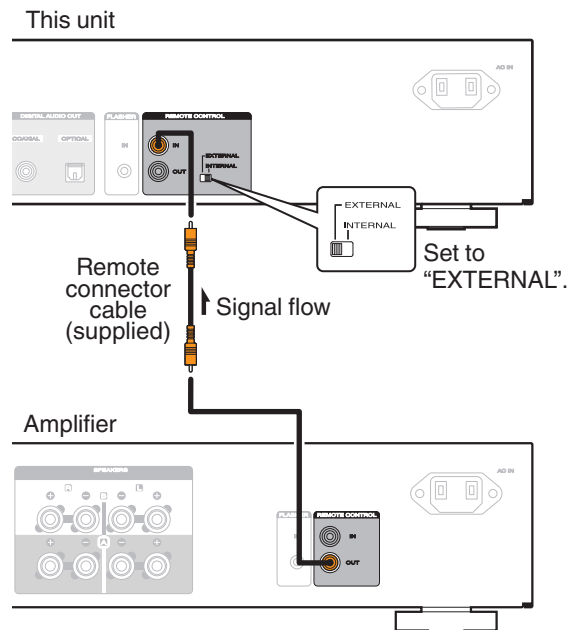

Connecting the timer device

This unit can perform timer play when an amplifier and timer device are connected to this unit. (“Timer Play” (🔍 p. 39))

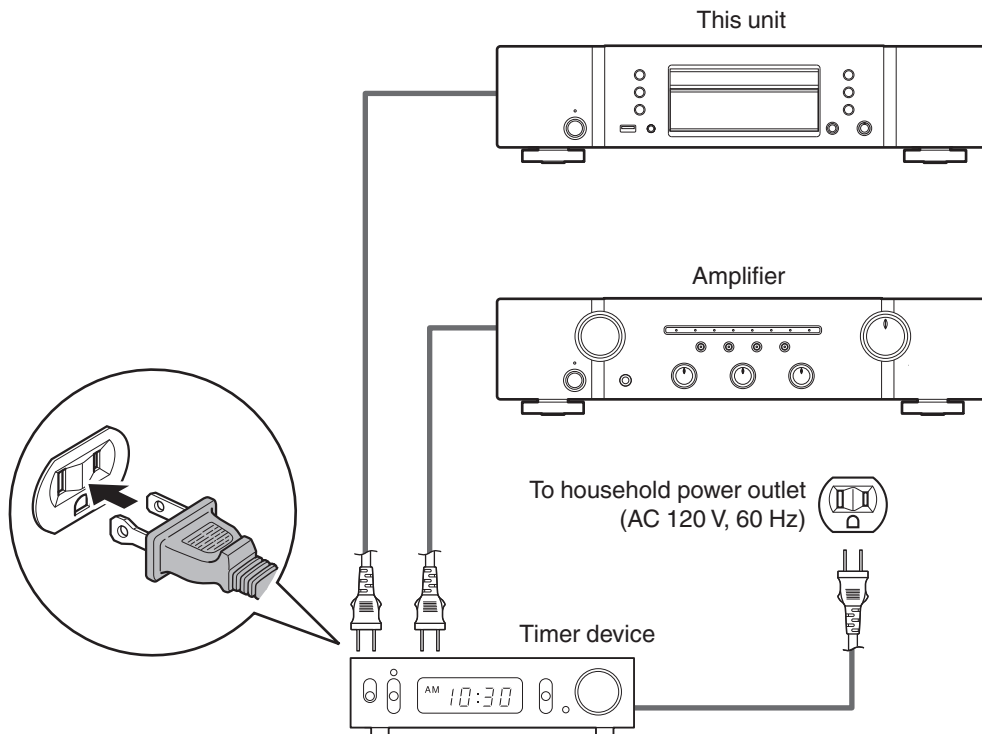

Connecting the power cord

After completing all the connections, insert the power plug into the power outlet.

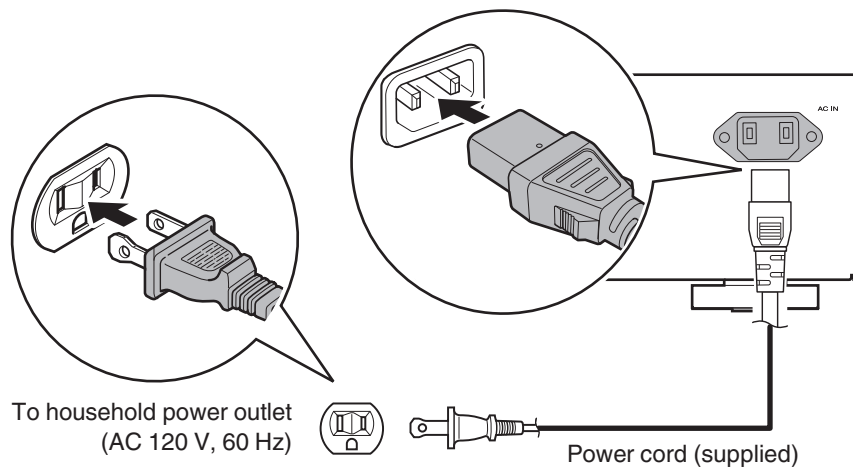

■ Contents

Basic operation	25
Playing CDs	27
Playing DATA CDs	30
Playing a USB memory device	33



Basic operation

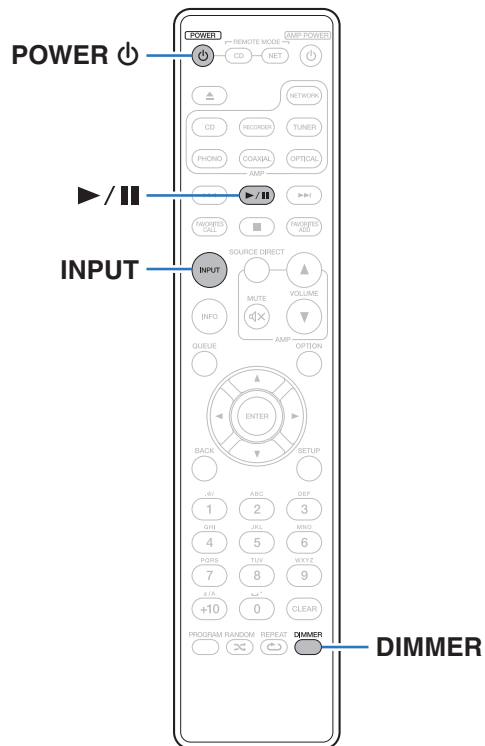

Turning the power on

1 Press **POWER** to turn on power to the unit.



- You can also press on the main unit to turn on power from standby mode.
- You can also press to turn on power from standby mode.

Switching the power to standby

1 Press **POWER** .

The unit switches to standby mode, and the Power indicator lights red.



- You can also switch the power to standby by pressing on the main unit.

NOTE

- Power continues to be supplied to some of the circuitry even when the power is in the standby mode. When leaving home for long periods of time or when going on vacation, unplug the power cord from the power outlet.



Selecting the playback media mode

1 Press INPUT to select the playback media mode.

Disc (Default):	Select to playback a disc.
USB:	Select to playback a USB memory device.



- You can also select the playback media mode by pressing DISC/INPUT on the main unit.

Switching the display's brightness

The display brightness can be adjusted between four levels. Switching the display off reduces a source of noise that affects sound quality, enabling higher sound quality playback.

1 Press DIMMER.

- The brightness of the display switches each time the button is pressed.



- The display brightness is set to most brightly by default.
- If buttons are operated when the display is off, information is temporarily displayed at the brightest setting.



Playing CDs

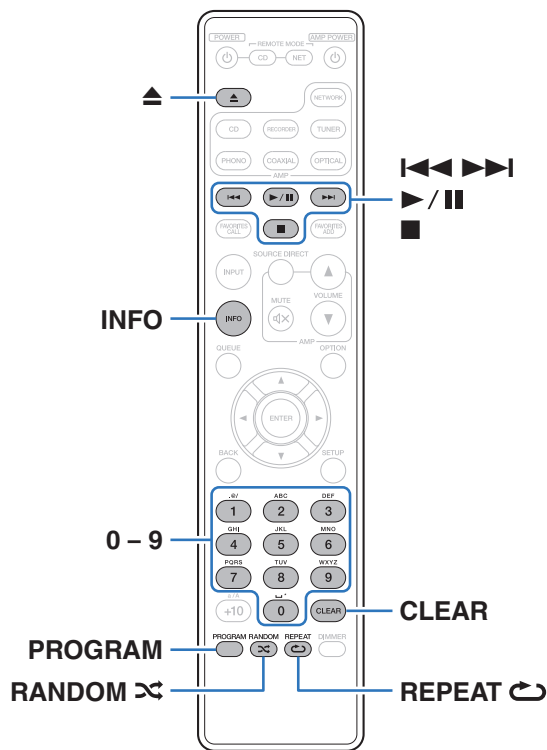





Playing CDs

- 1 Insert a disc. (p. 54)**
 - Press ▲ to open/close the disc tray.
- 2 Press ►/||.**
 - The ► indicator lights on the display. Playback starts.

NOTE

- Do not place any foreign objects in the disc tray. Doing so could damage the unit.
- Do not push the disc tray in by hand when the power is turned off. Doing so could damage the unit.



Operation buttons	Function
	Playback / Pause
	Stop
	Skip to previous track / Skip to next track (Press and hold) Fast-reverse / Fast-forward
0 - 9	Select the track
RANDOM 	Random playback
REPEAT 	Repeat playback <ul style="list-style-type: none"> Switching between All-track repeat, Single-track repeat and Repeat off.
INFO	Time display switching <ul style="list-style-type: none"> Switching between elapsed time of the current track, remaining time of the current track and remaining time of all tracks. The time displayed on this unit may differ from this actual time, as it is calculated by truncating to the nearest 1 second.

■ Discs that can be played back

- See "About Playing Back Discs". (📖 p. 49)

■ Playing a specific track (Direct searching)

1 Use 0 – 9 to select the tracks.

[Example]

Track 4 :

Press number 4 to select track 4.

Track 12 :

Press numbers 1 and 2 consecutively to select track 12.



Playing tracks in a specific order (Program playback)

Up to 25 tracks can be programmed.

1 In the stop mode, press PROGRAM.

“Program” appears on the display.

2 Use 0 – 9 to select the tracks.

[Example]

Track 4 :

Press number 4 to select track 4.



Track 12 :

Press numbers 1 and 2 consecutively to select track 12.

3 Press ►/II.

Playback starts in the programmed order.



- The program is cleared when the disc tray is opened or the power is turned off.
- When RANDOM  is pressed during program playback, the programmed tracks are played in random order.
- When REPEAT  is pressed during program playback, the tracks are played repeatedly in the programmed order.

■ Checking the order of the programmed tracks

In the stop mode, press ►►I.

The tracks are shown in the programmed order in the display each time ►►I is pressed.

■ To clear the last track programmed

In the stop mode, press CLEAR.

The last track programmed is cleared each time the button is pressed.



- You can also select a track to be cleared by pressing ►►I.

■ Clearing the all programmed track

In the stop mode, press PROGRAM.



Playing DATA CDs

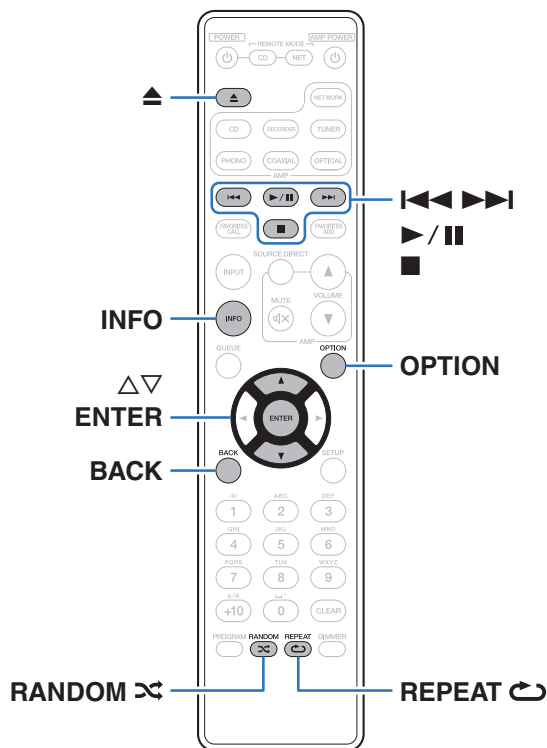

- This section explains how to playback music files that are recorded onto a CD-R/CD-RW.
- There are many music distribution sites on the Internet allowing you to download music files in MP3 or WMA (Windows Media® Audio) format. The music (files) downloaded from such sites can be stored on CD-R/CD-RW discs and played on this unit.
- The audio format types and specifications supported by this unit for playback are as follows.
See “Playable files” for details. (👉 p. 49)
 - **MP3**
 - **WMA**

NOTE



- Copyright-protected files cannot be played.
- Note that depending on the software used for burning and other conditions, some files may not play or display correctly.

“Windows Media” and “Windows” are the trademarks or registered trademarks of Microsoft Corporation in the United States and other countries.



Playing files

- 1 Load a CD-R/CD-RW disc containing music files into the disc tray. (👉 p. 54)
 - Press **▲** to open/close the disc tray.
- 2 Use **Δ∇** to select the music file to be played from the CD-R/CD-RW music data, then press **ENTER**.
Playback starts.

Operation buttons	Function
▶/ 	Playback / Pause
■	Stop
⏮⏭	Skip to previous track / Skip to next track (Press and hold) Fast-reverse / Fast-forward
BACK	Moving up a level in the folder tree
Δ∇	Select the item
ENTER	Enter the selected item / Playback
OPTION	Select the playback range
RANDOM 	Random playback
REPEAT 	Repeat playback <ul style="list-style-type: none"> • Switching between All-track repeat, Single-track repeat and Repeat off.
INFO	Switches the display between Title name / Artist name, Title name / Album name and File name.



- To start playing another file during playback of a CD-R/CD-RW, first press **BACK** to display the file tree. Next, use **Δ∇** to select the file to be played and press **ENTER**.



■ Switching the display

During playback, press INFO.

- Switches the display between Title name / Artist name, Title name / Album name and File name.
- If a file does not support text information or no track information is recorded, the file name is displayed.
- The player can display the following characters:

ABCDEFGHIJKLMNOPQRSTUVWXYZ

abcdefghijklmnopqrstuvwxyz

0123456789

! " # \$ % & ; : < > ? @ \ [] _ ` | { } ~ ^ ' () * + , - . / = space

- Any characters that cannot be displayed are replaced with "." (period).

■ Switching the playback range

In the stop mode, press OPTION.

- The playback range of a track can be set.

Folder mode:

All the files in the selected folder are played. The "FLD" indicator on the display lights at this time.

All mode:

All the files in the disc are played.



Playing a USB memory device

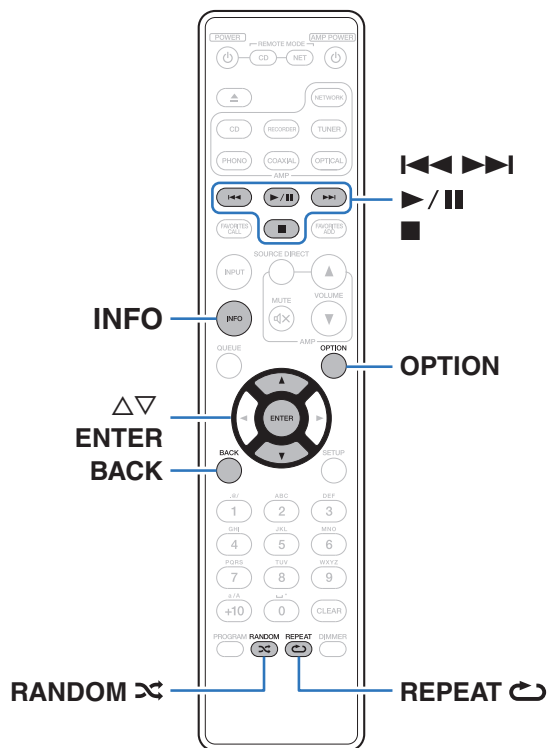

- Playing back music files stored on a USB memory device.
- Only USB memory devices conforming to mass storage class standards can be played on this unit.
- The audio format types and specifications supported by this unit for playback are as follows.
For details, see “Playing back a USB memory devices” (📖 p. 51).

- WMA
- MP3
- WAV
- MPEG-4 AAC
- FLAC
- Apple Lossless
- AIFF
- DSD



Playing files stored on USB memory devices





1 Insert a USB memory device into the USB port.

When you insert a USB memory device into the USB port, the media mode automatically switches to "USB".

2 Use $\Delta \nabla$ to select the folder to be played, then press ENTER.

3 Use $\Delta \nabla$ to select the file to be played, then press ENTER.

Playback starts.

Operation buttons	Function
	Playback / Pause
	Stop
	Skip to previous track / Skip to next track (Press and hold) Fast-reverse / Fast-forward
BACK	Moving up a level in the folder tree
$\Delta \nabla$	Select the item
ENTER	Enter the selected item / Playback
OPTION	Select the playback range
RANDOM 	Random playback
REPEAT 	Repeat playback <ul style="list-style-type: none"> Switching between All-track repeat, Single-track repeat and Repeat off.
INFO	Switches the display between Title name / Artist name, Title name / Album name and File name.



- To start playing another file during playback of a USB memory device, first press BACK to display the file tree. Next, use $\Delta \nabla$ to select the file to be played and press ENTER.



NOTE

- Note that Marantz will accept no responsibility whatsoever for any problems arising with the data on a USB memory device when using this unit in conjunction with the USB memory device.
- When a USB memory device is connected to this unit, the unit loads all of the files on the USB memory device. Loading may take a while if the USB memory device contains a large number of folders and/or files.

■ Switching the playback range

Press OPTION.

- The playback range of a track can be set.

Folder mode:	All the files in the selected folder are played. The “FLD” indicator on the display lights at this time.
All mode:	All the files in the USB memory are played.



Menu map

For menu operations, see the following page.

By default, this unit has recommended settings defined. You can customize this unit based on your existing system and your preferences.

Setting items	Description	Page
H/P AMP Gain	Set the gain of the headphone amplifier.	38
Filter	This unit is equipped with a sound quality adjusting function which allows users to enjoy the desired playback sound quality.	38
Digital Out	Switched the digital audio output on/off.	39
Timer Play	This unit can perform timer play by cooperating with your timer device.	39
Auto-Standby	Sets whether to automatically switch the unit to the standby mode when the unit remains in the stop mode for more than 30 minutes.	40



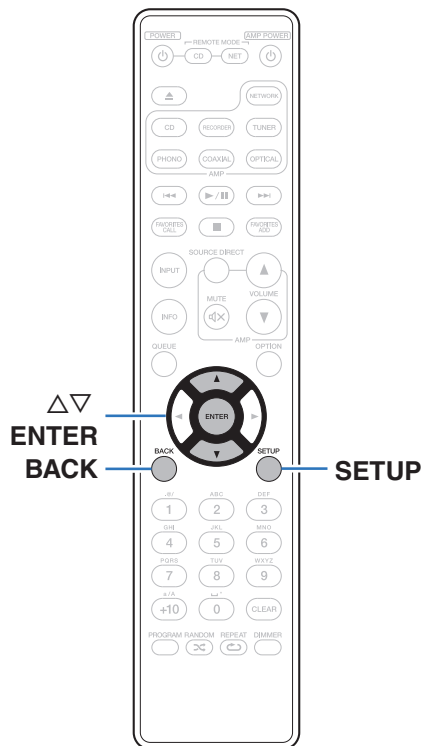

Menu operation

- 1 Press SETUP while playback is stopped.**
The menu is displayed on the display.
- 2 Use Δ / ∇ to select the menu to be set or operated, then press ENTER.**
- 3 Use Δ / ∇ to change to desired setting.**
- 4 Press ENTER to enter the setting.**
 - To return to the previous item, press BACK.
 - Exiting the Menu, press SETUP while the menu is displayed. The display returns to the normal display.



H/P AMP GAIN

Set the gain of the headphone amplifier. Set this according to the impedance of the connected headphones. It is recommended that this is set on the “Low” side if the headphones have low impedance and on the “High” side if they have high impedance.

High:	Set the gain of the headphone amplifier to “High”. Set when there is insufficient volume, even when the gain setting is “Mid”.
Mid:	Set the gain of the headphone amplifier to “Mid”. Set when there is insufficient volume, even when the gain setting is “Low”.
Low (Default):	Set the gain of the headphone amplifier to “Low”.

NOTE

- The headphone volume varies depending on the “H/P AMP GAIN” setting. Decrease the volume or mute the audio first if changing this setting while listening to audio.

Filter

This unit is equipped with a sound quality adjusting function which allows users to enjoy the desired playback sound quality. The unit supports PCM signal.

Filter 1 (Default):

Offers a short impulse response for both pre-echo and post-echo. Large amount of audio information clearly reproduces deep stereo imaging and the relative position of the sound source.

Filter 2:

Both pre-echo and post-echo are slightly longer. The sound characteristics is edge and powerful.



Digital Out

Switched the digital audio output on/off.

On (Default):	Use the digital audio output connector.
Off:	Do not use the digital audio output connector.

Timer Play

This unit can perform timer play by cooperating with your timer device. (“Connecting the timer device” (🔗 p. 22))

Disc:	Set the media mode for timer play to “Disc”.
USB:	Set the media mode for timer play to “USB”.
Off (Default):	Timer play is not set.

■ Using the timer play function

1. Turn on the power of the connected components. (🔗 p. 22)
2. Load a disc or connect a USB memory device.
3. Switch the amplifier’s function to input from the connected unit.
4. Set the audio timer for the desired times.
5. Turn the timer on.
 - The power of the components connected to the timer turns off.
 - When the set time is reached, the power of the different components automatically turns on and playback starts from the first track.



- The timer play does not support the random play or program play.



Auto-Standby

Sets whether to automatically switch the unit to the standby mode when the unit remains in the stop mode for more than 30 minutes.

On: Enable Auto Standby mode.

Off
(Default): Disable Auto Standby mode.



■ Contents

Tips

I want to switch the filter to change the desired sound quality	42
I want to playback just the specified folder	42
I want to randomly play back all tracks on a CD-R/CD-RW	42
I want to playback WAV files	42
I want to use this unit's remote control to operate a Marantz network audio player	42

Troubleshooting

Power does not turn on / Power is turned off	44
Operations cannot be performed through the remote control unit	45
Display on this unit shows nothing	45
No sound comes out	46
Sound is interrupted or noise occurs	46
Desired sound does not come out	46
USB memory devices cannot be played back	47
Cannot playback Discs	48



Tips

I want to switch the filter to change the desired sound quality

- Switch the filter characteristics. (👉 p. 38)

I want to playback just the specified folder

- Press the OPTION button to set the playback mode to folder playback mode. (👉 p. 32)

I want to randomly play back all tracks on a CD-R/CD-RW

- Before playback, press the OPTION button to set the playback mode to “All Mode”, then press the RANDOM  for random playback. (👉 p. 32)

I want to playback WAV files

- This unit can playback WAV files that are stored on a USB memory device. (👉 p. 51)

I want to use this unit's remote control to operate a Marantz network audio player

- Press the REMOTE MODE NET button on the remote control unit to switch the remote control unit to the network audio player operation mode. (👉 p. 15)
- Also, refer to the instruction manual of the network audio player.



Troubleshooting

If a problem should arise, first check the following:

1. Are the connections correct?
2. Is the set being operated as described in the owner's manual?
3. Are the other devices operating properly?

If this unit does not operate properly, check the corresponding symptoms in this section.

If the symptoms do not match any of those described here, consult your dealer as it could be due to a fault in this unit. In this case, disconnect the power immediately and contact the store where you purchased this unit.



Power does not turn on / Power is turned off

Power is not turned on.

- Check whether the power plug is correctly inserted into the power outlet. (👉 p. 23)
- This unit is in standby mode. Press the POWER ⏻ button on the remote control. (👉 p. 25)

Power automatically turns off.

- The auto standby mode setting is on. The auto standby mode automatically switches the unit to standby if there are no operations for more than 30 minutes. To disable the Auto Standby mode, set "Auto-Standby" on the menu to "Off". (👉 p. 40)

The power turns off and the power indicator shows one long blink and three short blinks in red.

- The protection circuit has been activated due to an error in the internal power supply. Unplug and reinsert the power cord, then press the ⏻ button to turn on the power again. If the problem is not solved by turning the power off and on again, unplug the power cord and contact our customer service center.



Operations cannot be performed through the remote control unit

Operations cannot be performed through the remote control unit.

- Batteries are worn out. Replace with new batteries. (🔍 p. 5)
- Operate the remote control unit within a distance of about 23 ft/7 m from this unit and at an angle of within 30°. (🔍 p. 5)
- Remove any obstacle between this unit and the remote control unit.
- Insert the batteries in the proper direction, checking the ⊕ and ⊖ marks. (🔍 p. 5)
- The unit's remote control sensor is exposed to strong light (direct sunlight, inverter type fluorescent bulb light, etc.). Move the set to a place in which the remote control sensor will not be exposed to strong light.
- When using a 3D video device, the remote control unit of this unit may not function due to effects of infrared communications between units (such as TV and glasses for 3D viewing). In this case, adjust the direction of units with the 3D communications function and their distance to ensure they do not affect operations from the remote control unit of this unit.
- Press the REMOTE MODE CD button to switch the remote control operating mode to "CD". (🔍 p. 11)
- When using this unit independently, set the switch to "INTERNAL". (🔍 p. 21)

Display on this unit shows nothing

Display is off.

- Press the DIMMER button, and change the setting to anything other than off. (🔍 p. 26)



No sound comes out

No sound is produced. Or sound is distorted.

- Check the connections for all devices. (👉 p. 17)
- Insert connection cables all the way in.
- Check that input connectors and output connectors are not reversely connected.
- Check cables for damage.
- Check the amplifier's functions and controls and adjust as necessary.

Sound is interrupted or noise occurs

During playback from the CD-R/CD-RW, sound is occasionally interrupted.

- This may be caused by poor recording conditions, or the disc itself may be of poor quality. Use a correctly recorded disc.

During playback from the USB memory device, sound is occasionally interrupted.

- When the transfer speed of the USB memory device is slow, sound may occasionally be interrupted.

Desired sound does not come out

Headphone volume is low.

- Switch "H/P AMP GAIN" to "Mid" or "High" if using headphones with high impedance or low sensitivity. (👉 p. 38)



USB memory devices cannot be played back

USB memory device is not recognized.

- Disconnect and reconnect the USB memory device. (👉 p. 20)
- Mass storage class compatible USB memory devices are supported.
- This unit does not support a connection through a USB hub. Connect the USB memory device directly to the USB port.
- The USB memory device must be formatted to FAT16 or FAT32.
- Not all USB memory devices are guaranteed to work. Some USB memory devices are not recognized. When using a type of portable hard disc drive compatible with the USB connection that requires power from an AC adapter, use the AC adapter that came with the drive.

Files on the USB memory device are not displayed.

- Files of a type not supported by this unit are not displayed. (👉 p. 51)
- This unit is able to display files in a maximum of eight folder layers. A maximum of 255 folders and 65025 files can be stored. Modify the folder structure of the USB memory device.
- When multiple partitions exist on the USB memory device, only files on the first partition are displayed.

iOS and Android devices are not recognized.

- The USB port of this unit does not support playback from iOS and Android devices.

Files on a USB memory device cannot be played.

- Files are created in a format that is not supported by this unit. Check the formats supported by this unit. (👉 p. 51)
- You are attempting to play a file that is copyright protected. Files that are copyright protected cannot be played on this unit.
- Playback may not be possible if the album art file size exceeds 2 MB.



Cannot playback Discs

Cannot playback when the play button is pressed, or cannot correctly play back a specific part of the disc.

- The disc is dirty or scratched. Either clean the disc, or insert a different disc. (👉 p. 55)

Cannot playback CD-R/CD-RW.

- Discs cannot be played back unless they have been finalized. Use a finalized disc. (👉 p. 49)
- This may be caused by poor recording conditions, or the disc itself may be of poor quality. Use a correctly recorded disc.
- Files are created in a format that is not supported by this unit. Check the formats supported by this unit. (👉 p. 49)

“No Disc” is displayed.

- “No Disc” is displayed if the disc is loaded upside-down or if no disc is loaded. Check that the disc is loaded label side up.

“System Error” is displayed.

- “System Error” is displayed when an error not caused by disc, format, etc., occurs. Contact our customer service center.

“Can't Read Disc” is displayed.



- “Can't Read Disc” is displayed when the inserted disc cannot be read because it is not compatible with this unit or is dirty or scratched. Check the disc.

“Wrong Format” is displayed.

- “Wrong Format” is displayed for files created in a format that is not supported by this unit. Check the formats supported by this unit. (👉 p. 49)



Playing back Discs

Playable media	
CD	
CD-R	
CD-RW	

NOTE

- Some discs and some recording formats cannot be played.
- Non-finalized discs cannot be played.

Files

■ Specifications of supported files

	Sampling frequency	Bit rate	Extension
MP3	32/44.1/48 kHz	48 – 320 kbps	.mp3
WMA	32/44.1/48 kHz	48 – 320 kbps	.wma

■ Maximum number of playable files and folders

Maximum number of folders : 256

Total number of folders and files : 512



NOTE

- Be sure to give files the extension. Files with any other extensions or files with no extensions cannot be played.
- Recordings you have made should only be used for your personal enjoyment, and as per copyright laws may not be used in other ways without permission of the copyright holder.



- Only music files that are not copyright-protected can be played on this unit.
 - Content downloaded from pay sites on the Internet are copyright protected. Also, files encoded in WMA format when ripped from a CD, etc. on a computer may be copyright protected, depending on the computer's settings.
- The maximum number of files and folders that can be played differs depending on conditions such as the length of the file name or folder name or the number of levels in the folder hierarchy.



Playing back a USB memory devices

- This unit is compatible with MP3 ID3-Tag (Ver. 2) standard.
- This unit is compatible with WMA META tags.
- If the image size (pixels) of an album artwork exceeds 500 × 500 (WMA/MP3/Apple Lossless/DSD) or 349 × 349 (MPEG-4 AAC), then music may not be played back properly.

■ Specifications of supported files

	Sampling frequency	Bit rate	Extension
WMA*1	32/44.1/48 kHz	48 – 320 kbps	.wma
MP3	32/44.1/48 kHz	48 – 320 kbps	.mp3
WAV	32/44.1/48/88.2/ 96/176.4/192 kHz	–	.wav
MPEG-4 AAC*1	32/44.1/48 kHz	48 – 320 kbps	.aac/.m4a/.mp4
FLAC	32/44.1/48/88.2/ 96/176.4/192 kHz	–	.flac
Apple Lossless*2	32/44.1/48/88.2/96 kHz	–	.m4a
AIFF	32/44.1/48/88.2/ 96/176.4/192 kHz	–	.aif/.aiff
DSD	2.8/5.6 MHz	–	.dsf/.dff

*1 Only files that are not protected by copyright can be played on this unit.
Content downloaded from pay sites on the Internet are copyright protected. Also, files encoded in WMA format when ripped from a CD, etc. on a computer may be copyright protected, depending on the computer's settings.

*2 The Apple Lossless Audio Codec (ALAC) decoder is distributed under the Apache License, Version 2.0 (<http://www.apache.org/licenses/LICENSE-2.0>).



■ Maximum number of playable files and folder

The limits on the number of folders and files that can be displayed by this unit are as follows.

Item	Media	USB memory device
Number of folder directory levels *1		8 levels
Number of folders		255
Number of files*2		65025

*1 The limited number includes the root folder.

*2 The allowable number of files may differ according to the USB memory device capacity and the file size.

Playback order of music files

When there are multiple folders containing music files, the playback order of folders is automatically set when this unit reads the media. Files in each folder are played in alphabetical order of file name.

CD-R/CD-RW and USB memory device

For playback of files on CD-R, CD-RW or USB memory device, files in all folders on the first layer are played first, next on the second layer, then next on the third layer, and so on in this order.



- The playback order displayed on a PC may differ from the actual playback order.
- The playback order with a CD-R/CD-RW may differ, depending on the writing software.
- The playback order may differ from the order in which the folders or files were recorded if you delete or add a folder or file on USB. This occurs because of data recording specifications and is not a malfunction.



About discs and files

Music files recorded on CD-R/-RW and USB memory device are divided into large segments (folders) and small segments (files).

Files are stored in folders, and folders can be placed for storage in a hierarchy. The unit can recognize up to 8 levels of folders.

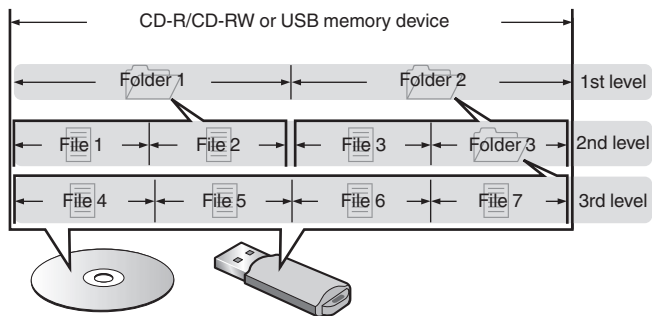

- When writing music files on a CD-R/CD-RW disc, set the writing software's format to "ISO9660". The files may not play properly if they are recorded in other formats. For details, refer to the instructions of your writing software.



Cautions on using media

Loading discs

- Set the disc in the tray label side up.
- Make sure the disc tray is fully open when inserting the disc.
- Place the discs flatly, 5 inch/12 cm discs in the outer tray guide (Figure 1), 3 inch/8 cm discs in the inner tray guide (Figure 2).

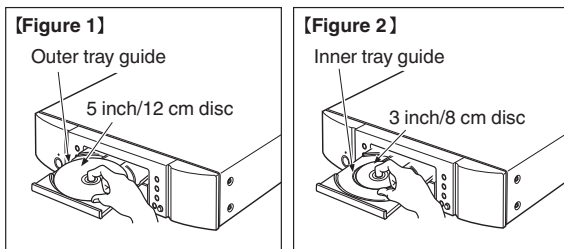

- Place 3 inch/8 cm discs in the inner tray guide without using an adapter.

NOTE

- Only load one disc at a time. Loading two or more discs can damage the unit or scratch the discs.
- Do not use cracked or warped discs or discs that have been repaired with adhesive, etc.
- Do not use discs on which the sticky part of cellophane tape or labels is exposed or on which there are traces of where labels have been removed. Such discs can get caught inside the player and damage it.
- Do not use discs in special shapes, as they may damage the unit.



- Do not push the disc tray in by hand when the power is off. Doing so could damage the unit.
- If the unit is left in a room full of smoke from cigarettes, etc., for long periods of time, the surface of the optical pickup may get dirty, preventing it from receiving signals properly.



How to handle media

- Do not get fingerprints, oil or dirt on discs.
- Take special care not to scratch discs when removing them from their cases.
- Do not bend or heat discs.
- Do not enlarge the hole in the center.
- Do not write on the labeled (printed) surface with ball-point pens, pencils, etc., or stick new labels on discs.
- Condensation may form on discs if they are moved suddenly from a cold place (outdoors for example) to a warm place, but do not try to dry discs with a hairdryer, etc.
- Do not eject a USB memory device or turn off the unit while a USB memory device is being played. This may result in malfunction or loss of the USB memory device's data.
- Do not attempt to open or modify a USB memory device.
- USB memory device and files can be damaged by static electricity. Do not touch the metal contacts of a USB memory device with your fingers.
- Do not use warped USB memory device.
- After use, be sure to remove any disc or USB memory device, and store it in its proper case, to avoid dust, scratches and deformation.
- Do not store discs in the following places:
 1. Places exposed to direct sunlight for long periods of time
 2. Dusty or humid places
 3. Places exposed to heat from heaters, etc.

Cleaning discs

- If there are fingerprints or dirt on a disc, wipe them off before using the disc.
- Use a commercially available disc cleaning set or a soft cloth to clean discs.



Gently wipe the disc from the inside towards the outside.

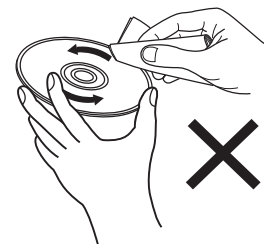

Do not wipe with a circular motion.

NOTE

- Do not use record spray, antistatic agents, benzene, thinner or other solvents.



Explanation of terms

AIFF (Audio Interchange File Format)

This is an uncompressed and lossless format for digital audio. Use AIFF files to burn high-quality audio CDs from imported songs. AIFF files use approximately 10 MB of disk space per minute.

Apple Lossless Audio Codec

This is a codec for lossless audio compression method developed by Apple Inc. This codec can be played back on iTunes, iPod or iPhone. Data compressed to approximately 60 – 70 % can be decompressed to exactly the same original data.

DSD (Direct-Stream Digital)

One of the audio data recording methods, it is the signal aspect used to store audio signals on a super audio CD, and is Δ - Σ modulated digital audio.

FLAC (Free Lossless Audio Codec)

FLAC stands for Free lossless Audio Codec, and is a lossless free audio file format. Lossless means that the audio is compressed without any loss in quality.

The FLAC license is as shown below.

Copyright (C) 2000, 2001, 2002, 2003, 2004, 2005, 2006, 2007, 2008, 2009 Josh Coalson

Redistribution and use in source and binary forms, with or without modification, are permitted provided that the following conditions are met:

- Redistributions of source code must retain the above copyright notice, this list of conditions and the following disclaimer.
- Redistributions in binary form must reproduce the above copyright notice, this list of conditions and the following disclaimer in the documentation and/or other materials provided with the distribution.
- Neither the name of the Xiph.org Foundation nor the names of its contributors may be used to endorse or promote products derived from this software without specific prior written permission.

THIS SOFTWARE IS PROVIDED BY THE COPYRIGHT HOLDERS AND CONTRIBUTORS "AS IS" AND ANY EXPRESS OR IMPLIED WARRANTIES, INCLUDING, BUT NOT LIMITED TO, THE IMPLIED WARRANTIES OF MERCHANTABILITY AND FITNESS FOR A PARTICULAR PURPOSE ARE DISCLAIMED. IN NO EVENT SHALL THE FOUNDATION OR CONTRIBUTORS BE LIABLE FOR ANY DIRECT, INDIRECT, INCIDENTAL, SPECIAL, EXEMPLARY, OR CONSEQUENTIAL DAMAGES (INCLUDING, BUT NOT LIMITED TO, PROCUREMENT OF SUBSTITUTE GOODS OR SERVICES; LOSS OF USE, DATA, OR PROFITS; OR BUSINESS INTERRUPTION) HOWEVER CAUSED AND ON ANY THEORY OF LIABILITY, WHETHER IN CONTRACT, STRICT LIABILITY, OR TORT (INCLUDING NEGLIGENCE OR OTHERWISE) ARISING IN ANY WAY OUT OF THE USE OF THIS SOFTWARE, EVEN IF ADVISED OF THE POSSIBILITY OF SUCH DAMAGE.



MP3 (MPEG Audio Layer-3)

This is an internationally standardized audio data compression scheme, using the “MPEG-1” video compression standard. It compresses the data volume to about one eleventh its original size while maintaining sound quality equivalent to a music CD.

MPEG (Moving Picture Experts Group), MPEG-2, MPEG-4

These are the names for digital compression format standards used for the encoding of video and audio. Video standards include “MPEG-1 Video”, “MPEG-2 Video”, “MPEG-4 Visual”, “MPEG-4 AVC”. Audio standards include “MPEG-1 Audio”, “MPEG-2 Audio”, “MPEG-4 AAC”.

WMA (Windows Media Audio)

This is audio compression technology developed by Microsoft Corporation.

WMA data can be encoded using Windows Media® Player.

To encode WMA files, only use applications authorized by Microsoft Corporation. If you use an unauthorized application, the file may not work properly.

Sampling frequency

Sampling involves taking a reading of a sound wave (analog signal) at regular intervals and expressing the height of the wave at each reading in digitized format (producing a digital signal).

The number of readings taken in one second is called the “sampling frequency”. The larger the value, the closer the reproduced sound is to the original.

Dynamic range

The difference between the maximum undistorted sound level and the minimum discernible level above the noise emitted by the device.

Bit rate

This is the amount of audio data recorded on a disc that is read in one second.

Finalizing

This process enables DVD/CD recorded with a recorder to be played by other players.

Linear PCM

This is an uncompressed PCM (Pulse Code Modulation) signal. Unlike lossy compression audio sources such as MP3, no audio quality or dynamic range deteriorates.



Trademark information



Adobe, the Adobe logo and Reader are either registered trademarks or trademarks of Adobe Systems Incorporated in the United States and/or other countries.



Specifications

■ Audio section

• Analog output

Channels:

Playable frequency range:

Playable frequency response:

S/N:

Dynamic range:

Harmonic distortion:

• Output level

Signal type:

Headphone output:

[PCM]

2-channel

2 Hz – 96 kHz
(sampling frequency: 192 kHz)
2 Hz – 20 kHz
(sampling frequency: 44.1 kHz)

2 Hz – 50 kHz (-3 dB)
(sampling frequency: 192 kHz)
2 Hz – 20 kHz
(sampling frequency: 44.1 kHz)

110 dB

110 dB (24 bits)
100 dB (16 bits)

0.0010 % (24 bits)
0.0016 % (16 bits)

[DSD]

2-channel

2 Hz – 100 kHz

2 Hz – 50 kHz (-3 dB)

110 dB (Audible range)

110 dB (Audible range)

0.0010 %

1.64 V RMS stereo

28 mW/32 Ω/ohms (variable maximum)



- **Optical readout system**

Laser:	AlGaAs
Wave length:	780 nm
Signal type:	16-bit linear PCM
Sampling frequency:	44.1 kHz

- **Digital output**

Coaxial:	0.5 Vp-p / 75 Ω /ohms
Optical :	-19 dBm

- **Digital input**

USB (Front):	USB Type A (USB 2.0 High speed)
---------------------	---------------------------------

■ General

Power supply:	AC 120 V, 60 Hz
Power consumption:	32 W
Power consumption in standby mode:	0.3 W
Operating temperature:	+5 °C - +35 °C
Operating humidity:	5 – 90 % (without dew)

For the purpose of improvement, the specifications and design are subject to change without notice.



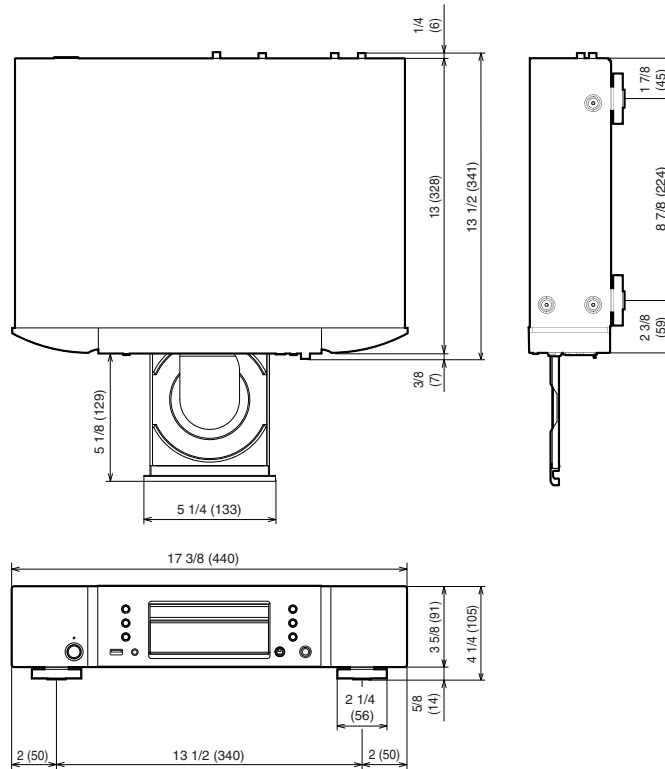

■ Dimensions (Unit : in. (mm))



■ Weight : 14 lbs 5 oz (6.5 kg)

Index

 A	
Amplifier	18, 19
Auto-Standby	40
 C	
CD	27
 D	
D/A converter	19
DATA CD	30
Display	9
Display's brightness	26

 F	
Front panel	6

 P	
Program playback	29

 R	
Rear panel	10
Remote control unit	11

 T	
Timer device	22
Tips	42
Troubleshooting	43



www.marantz.com

You can find your nearest authorized distributor or dealer on our website.

marantz is a registered trademark.