



BASS MODULE 700

CHOOSE YOUR SETUP METHOD



Your setup method depends on which soundbar or speaker you have.

- **Bose Soundbar 500, Bose Soundbar 700, or Bose Smart Soundbar 300:**
See page 4.
- **Bose TV Speaker** (or alternate wired setup for soundbars): See page 5.
- **SoundTouch 300 soundbar:**
See page 6.

VÆLG OPSÆTNINGSMETODE

Opsætningsmetoden afhænger af, hvilken soundbar eller højttaler du har.

- **Bose Soundbar 500, Bose Soundbar 700 eller Bose Smart Soundbar 300:** Se side 8.
- **Bose TV Speaker** (eller alternativ kabelbaseret opsætning for soundbars): Se side 9.
- **SoundTouch 300 soundbar:** Se side 10.

AUSWÄHLEN DER EINRICHTUNGSMETHODE

Die Einrichtungsmethode hängt davon ab, welche Soundbar bzw. welchen Lautsprecher Sie haben.

- **Bose Soundbar 500, Bose Soundbar 700 oder Bose Smart Soundbar 300:**
Siehe Seite 12.
- **Bose TV Speaker** (oder alternatives, kabelgebundenes Setup für Soundbars):
Siehe Seite 13.
- **SoundTouch 300 Soundbar:** Siehe Seite 14.

KIES UW INSTALLATIEMETHODE

Uw installatiemethode is afhankelijk van welke soundbar of luidspreker u hebt.

- **Bose Soundbar 500, Bose Soundbar 700 of Bose Smart Soundbar 300:** Zie pagina 16.
- **Bose TV Speaker** (of alternatieve bedrade installatie voor soundbars): Zie pagina 17.
- **SoundTouch 300 soundbar:** Zie pagina 18.

ELEGIR EL MÉTODO DE CONFIGURACIÓN

El método de configuración depende de la barra de sonido o del altavoz que tenga.

- **Bose Soundbar 500, Bose Soundbar 700 o Bose Smart Soundbar 300:**
Vea la página 20.
- **Bose TV Speaker** (o una configuración alternativa de barras de sonido con cable):
Vea la página 21.
- **Barra de sonido SoundTouch 300:**
Vea la página 22.

VALITSE MÄÄRITYSTAPA.

Määritystapa vaihtelee käytettävän soundbarin tai kaiuttimen mukaan.

- **Bose Soundbar 500, Bose Soundbar 700 tai Bose Smart Soundbar 300:** Ks. sivu 24.
- **Bose TV Speaker** (tai soundbarin vaihtoehtoinen liitäntä johdolla):
Ks. sivu 25.
- **SoundTouch 300 soundbar:** Ks. sivu 26.

SÉLECTION DE LA MÉTHODE DE CONFIGURATION

La méthode de configuration dépend de votre barre de son ou de votre enceinte.

- **Bose Soundbar 500, Bose Soundbar 700 ou Bose Smart Soundbar 300 :** reportez-vous à la page 28.
- **Bose TV Speaker** (ou configuration câblée alternative pour barres de son) : reportez-vous à la page 29.
- **Barre de son SoundTouch 300 :** reportez-vous à la page 30.

SCEGLIERE IL METODO DI CONFIGURAZIONE

Il metodo di configurazione dipende dal tipo di soundbar o diffusore in uso.

- **Bose Soundbar 500, Bose Soundbar 700 o Bose Smart Soundbar 300:** Vedere pagina 32.
- **Bose TV Speaker** (o configurazione cablata alternativa per le soundbar): Vedere pagina 33.
- **Soundbar SoundTouch 300:** Vedere pagina 34.

VÁLASSZA KI A BEÁLLÍTÁSI MÓDSZERT

A beállítási módszer attól függően változik, hogy melyik hangsugárzóval vagy hangszóróval rendelkezik.

- **Bose Soundbar 500, Bose Soundbar 700 vagy Bose Smart Soundbar 300:** Lásd: 36. oldal.
- **Bose TV Speaker** (vagy alternatív vezetékes kapcsolat hangsugárzókhöz): Lásd: 37. oldal.
- **SoundTouch 300 hangsugárzó:** Lásd: 38. oldal.

VELGE METODE FOR KONFIGURERING

Konfigurasjonsmetoden avhenger av lydplanken eller høyttaleren.

- **Bose Soundbar 500, Bose Soundbar 700 eller Bose Smart Soundbar 300:** Se side 40.
- **Bose TV Speaker** (eller alternativt kablet oppsett for lydplanker): Se side 41.
- **SoundTouch 300 soundbar:** Se side 42.

WYBÓR METODY KONFIGURACJI

Metoda konfiguracji zależy od rodzaju zestawu soundbar lub głośnika.

- **Głośnik Bose Soundbar 500, Bose Soundbar 700, lub Bose Smart Soundbar 300:** Zobacz str. 44.
- **Głośnik Bose TV Speaker** (lub alternatywna przewodowa konfiguracja dla głośników soundbar): Zobacz str. 45.
- **Głośnik soundbar SoundTouch 300:** Zobacz str. 46.

ESCOLHER SEU MÉTODO DE CONFIGURAÇÃO

Seu método de configuração depende da barra de som ou do alto-falante que você tem.

- **Bose Soundbar 500, Bose Soundbar 700 ou Bose Smart Soundbar 300:** Consulte a página 48.
- **Bose TV Speaker** (ou configuração alternativa com fio para barras de som): Consulte a página 49.
- **Barra de som SoundTouch 300:** Consulte a página 50.

VÄLJA INSTALLATIONSMETOD

Installationsmetoden beror på vilken soundbarhögtalare eller högtalare du har.

- **Bose Soundbar 500, Bose Soundbar 700 eller Bose Smart Soundbar 300:** Se sidan 52.
- **Bose TV-högtalare** (eller alternativt kabelansluten inställning för soundbarhögtalare): Se sidan 53.
- **SoundTouch 300 soundbarhögtalare:** Se sidan 54.

BOSE SOUNDBAR 500, BOSE SOUNDBAR 700, BOSE SMART SOUNDBAR 300

①

Place the bass module

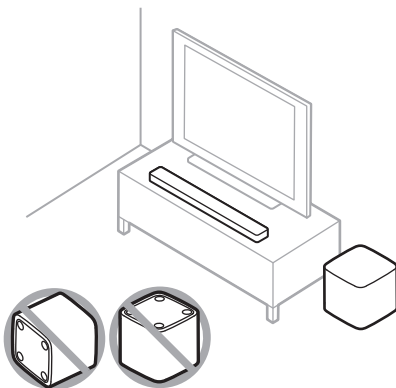

Keep at least 1 - 3 ft. (0.3 - 0.9 m) away from other wireless equipment.

②

Set up using the Bose Music app

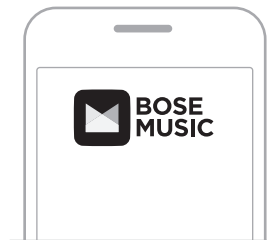

- In the Bose Music app, from the **My Bose** screen, tap your soundbar.
- Tap the soundbar image in the bottom-right corner of the screen.
- Tap **Settings** > **Accessory Speakers** > **Add Bose Accessory Speakers**.

New to the Bose Music app?

Download the app and follow the app instructions to set up your soundbar and bass module.

BOSE TV SPEAKER (OR ALTERNATE WIRED SETUP FOR SOUNDBARS)

①

Place the bass module

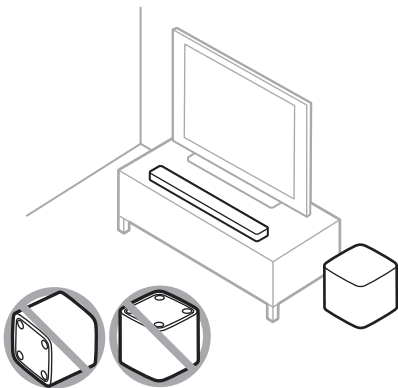

Keep at least 1 - 3 ft. (0.3 - 0.9 m) away from other wireless equipment.

②

Connect the bass module to power

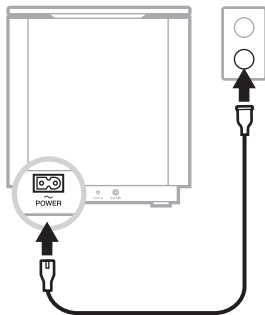

Once connected, the bass module powers on.

③

Connect the bass module to the speaker

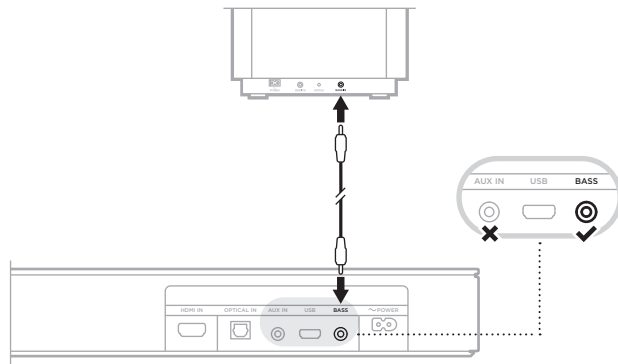

Connect a 3.5 mm audio cable (not provided) to the bass module's **BASS IN** connector and the speaker's **BASS** connector (not the **AUX IN** connector).

NOTE: If you don't have a 3.5 mm audio cable, visit worldwide.bose.com/Support/BASS700 to purchase a 15 ft. (4.5 m) cable or go to your local electronics store.

SOUNDTOUCH 300 SOUNDBAR

①

Place the bass module

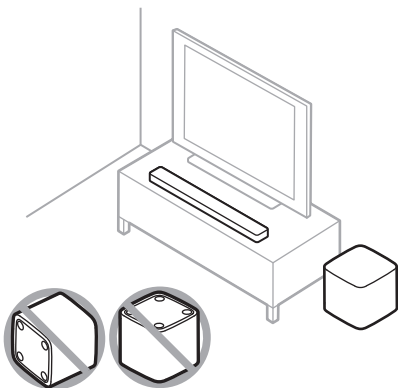

Keep at least 1 - 3 ft. (0.3 - 0.9 m) away from other wireless equipment.

②

Connect the bass module to power

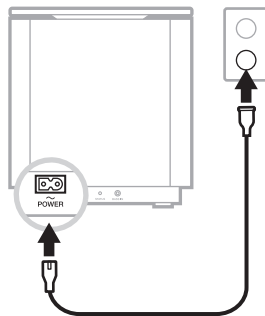



Once connected, the bass module powers on.

③

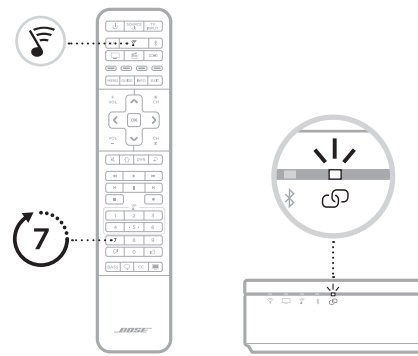
Connect the bass module to the soundbar



- A. On your SoundTouch 300 remote control, press .
- B. Press and hold 7 until  on the soundbar blinks white. Once the bass module connects, you hear a tone and  glows white.

NOTE: Connecting may take several minutes.

④

Set up ADAPTiQ audio calibration

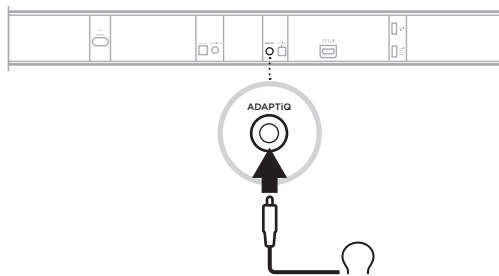



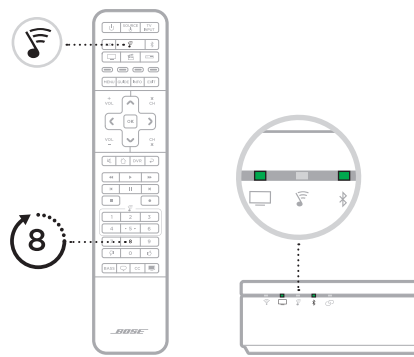

- A. Connect the ADAPTiQ headset (included with the soundbar) to the soundbar's ADAPTiQ connector.
- B. Put the headset on your head.

⑤

Run ADAPTiQ audio calibration



- A. On your SoundTouch 300 remote control, press .
 - B. Press and hold 8 until  and  on the soundbar glow green.
- NOTE:** To cycle through languages, press  and  on the navigation pad.

BOSE SOUNDBAR 500, BOSE SOUNDBAR 700, BOSE SMART SOUNDBAR 300

①

Placer basmodulet

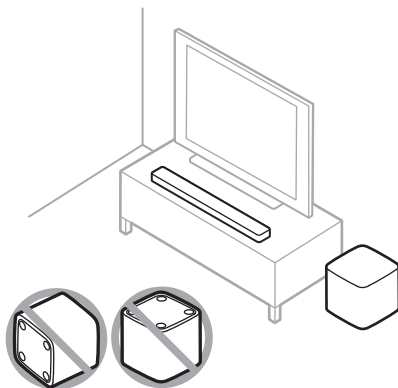

Hold produktet mindst 0,3-0,9 meter væk fra andet trådløst udstyr.

②

Opsætning ved hjælp af Bose Music-appen

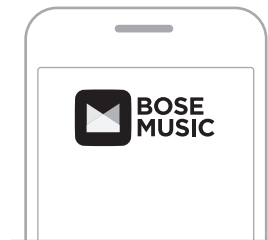

- I Bose Music-appen skal du trykke på din soundbar på skærmbilledet **My Bose**.
- Tryk på soundbarbilledet i nederste højre hjørne af skærmbilledet.
- Tryk på **Settings** > **Accessory Speakers** > **Add Bose Accessory Speakers**.

Er det første gang du bruger Bose Music-appen?

Download appen, og følg instruktionerne i appen for at konfigurere din soundbar og basmodulet.

BOSE TV SPEAKER (ELLER ALTERNATIV KABELBASERET OPSÆTNING FOR SOUNDBARS)

①

Placer basmodulet

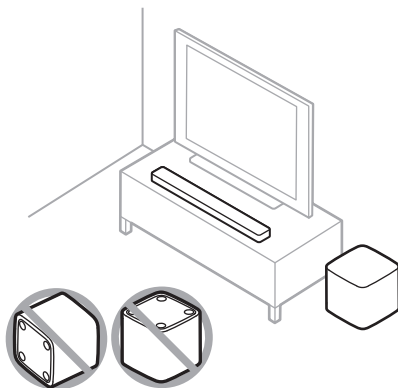

Hold produktet mindst 0,3-0,9 meter væk fra andet trådløst udstyr.

②

Slut basmodulet til strøm

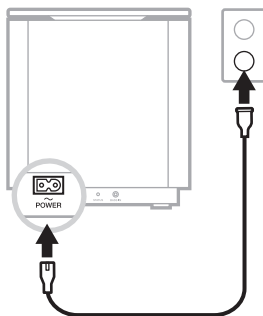

Når tilslutningen er foretaget, tændes basmodulet.

③

Tilslut basmodulet til højttaleren

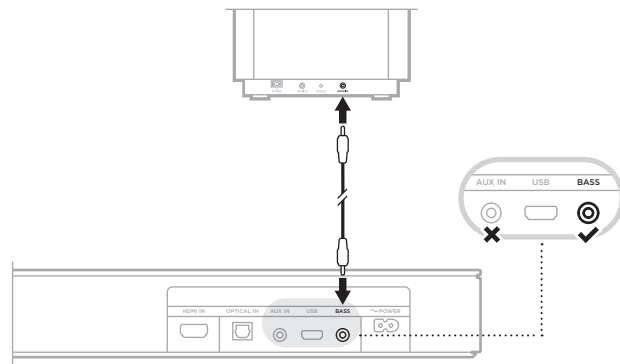

Tilslut et 3,5 mm lyd kabel (medfølger ikke) til basmodulets BASS IN-stik og højttalerens BASS-stik (ikke AUX IN-stikket).

BEMÆRK: Hvis du ikke har et 3,5 mm lyd kabel, skal du gå til worldwide.Bose.com/Support/BASS700 for at købe et 4,5 m kabel eller henvende dig i din lokale elektronikforretning.

SOUNDTOUCH 300 SOUNDBAR

①

Placer basmodulet

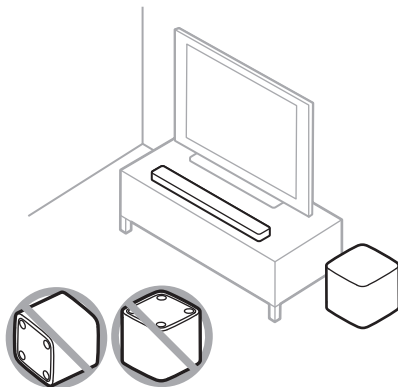

Hold produktet mindst 0,3-0,9 meter væk fra andet trådløst udstyr.

②

Slut basmodulet til strøm

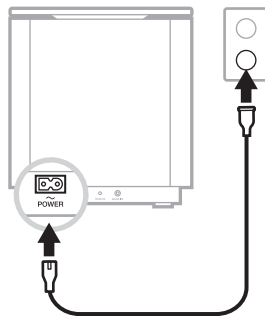



Når tilslutningen er foretaget, tændes basmodulet.

③

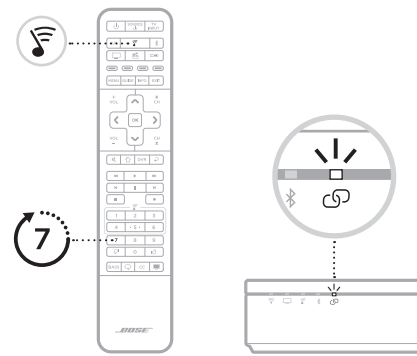
Tilslut basmodulet til soundbaren



- A. På fjernbetjeningen til SoundTouch 300 skal du trykke på .
 - B. Tryk og hold 7, indtil  på din soundbar blinker hvidt.
- Når basmodulet opretter forbindelse, høres der en tone, og  lyser hvidt.

BEMÆRK: Det kan tage flere minutter at oprette forbindelse.

④

Konfigurer ADAPTiQ lydkalibrering

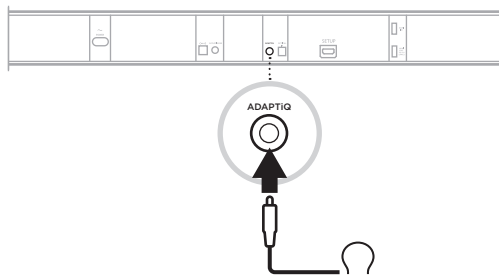



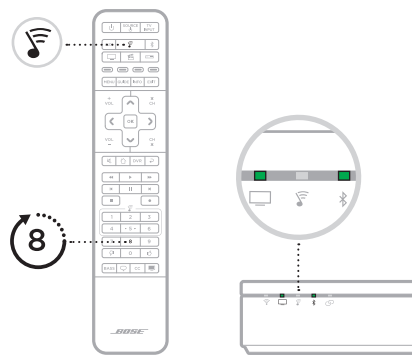

- A. Tilslut ADAPTiQ-headsettet (følger med din soundbar) til stikket ADAPTiQ på din soundbar.
- B. Sæt headsettet på dit hoved.

⑤

Kør ADAPTiQ lydkalibrering



- A. På fjernbetjeningen til SoundTouch 300 skal du trykke på .
- B. Tryk og hold 8, indtil  og  på din soundbar lyser grønt.

BEMÆRK: For at gå igennem de forskellige sprog skal du trykke på  og  i navigationsfeltet.

BOSE SOUNDBAR 500, BOSE SOUNDBAR 700, BOSE SMART SOUNDBAR 300

①

Aufstellen des Bassmoduls

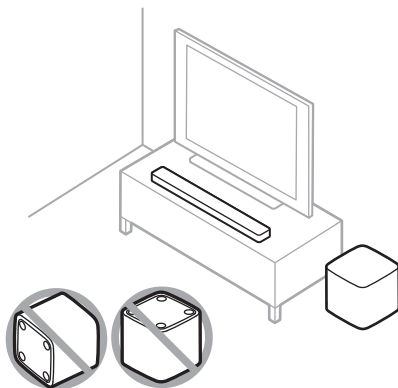

Halten Sie mindestens 0,3 bis 0,9 m Abstand von anderen Drahtlosgeräten.

②

Einrichten mithilfe der Bose Music-App

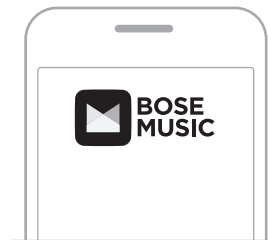

- Tippen Sie in der Bose Music-App auf dem Bildschirm **Mein Bose** auf Ihre Soundbar.
- Tippen Sie auf das Soundbar-Bild unten rechts auf dem Bildschirm.
- Tippen Sie auf **Einstellungen** > **Zusatzlautsprecher** > **Bose-Zusatzlautsprecher hinzufügen**.

Kennen Sie die Bose Music-App noch nicht?

Laden Sie die App jetzt herunter und folgen Sie den Anweisungen in der App, um Ihre Soundbar und das Bassmodul einzurichten.

BOSE TV SPEAKER (ODER ALTERNATIVES, KABELGEBUNDENES SETUP FÜR SOUNDBARS)

①

Aufstellen des Bassmoduls

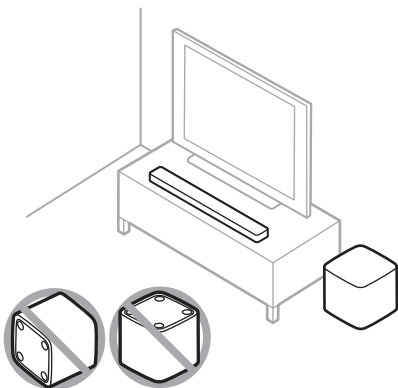

Halten Sie mindestens 0,3 bis 0,9 m Abstand von anderen Drahtlosgeräten.

②

Anschließen des Bassmoduls an den Strom

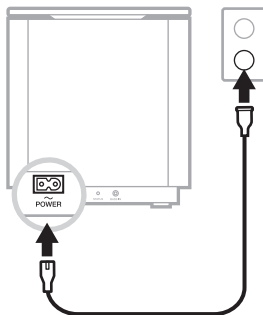

Nach dem Anschließen schaltet sich das Bassmodul ein.

③

Anschließen des Bassmoduls an den Lautsprecher

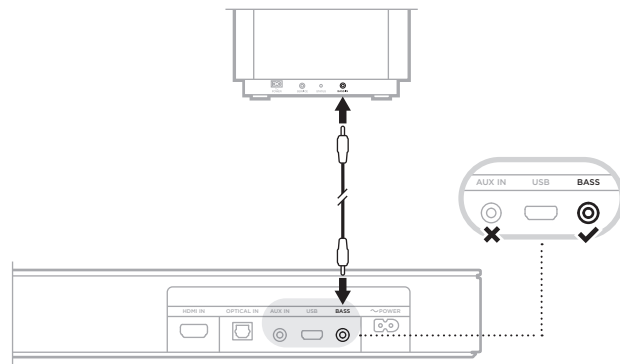

Schließen Sie ein 3,5-m-Audiokabel (nicht mitgeliefert) an den Anschluss **BASS IN** des Bassmoduls und den Anschluss **BASS** (nicht den Anschluss **AUX IN**) des Lautsprechers an.

HINWEIS: Wenn Sie kein 3,5-mm-Audiokabel haben, besuchen Sie worldwide.bose.com/Support/BASS700, um ein 4,5 m langes Kabel zu erwerben, oder gehen Sie zu einem Elektronikfachgeschäft vor Ort.

SOUNDTOUCH 300 SOUNDBAR

①

Aufstellen des Bassmoduls

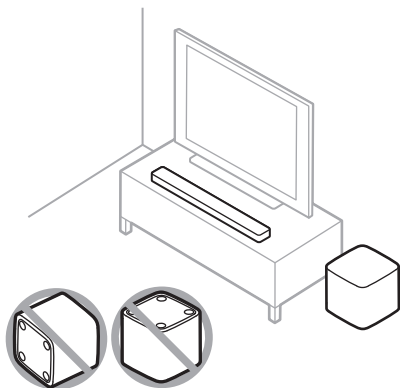

Halten Sie mindestens 0,3 bis 0,9 m Abstand von anderen Drahtlosgeräten.

②

Anschließen des Bassmoduls an den Strom

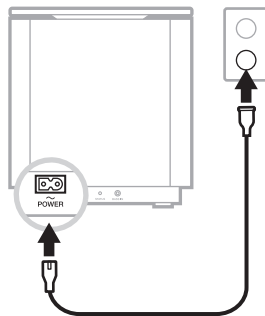



Nach dem Anschließen schaltet sich das Bassmodul ein.

③

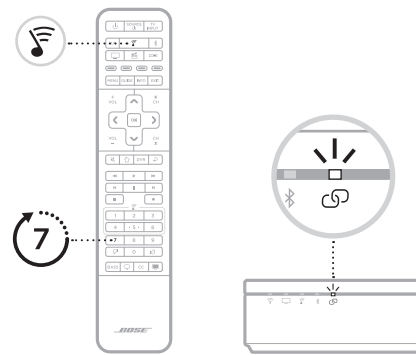
Anschließen des Bassmoduls an die Soundbar



- A. Drücken Sie auf der SoundTouch 300-Fernbedienung .
- B. Halten Sie 7 gedrückt, bis  an der Soundbar weiß blinkt. Sobald das Bassmodul verbunden ist, hören Sie einen Ton und  leuchtet weiß.

HINWEIS: Das Verbinden kann mehrere Minuten dauern.

④

Einrichten der ADAPTiQ®-Audiokalibrierung

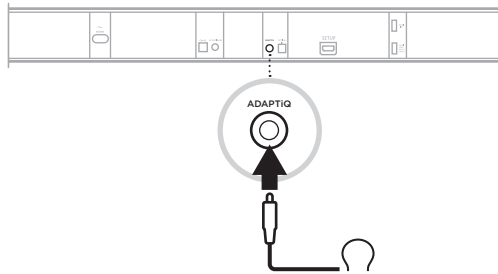



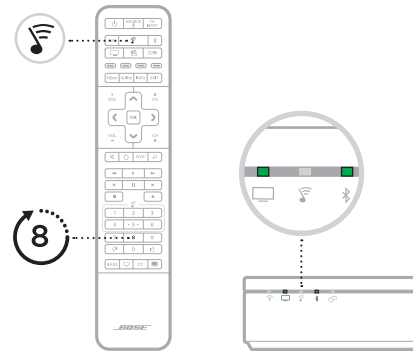

- A. Schließen Sie das ADAPTiQ-Headset (mit der Soundbar mitgeliefert) an den Anschluss ADAPTiQ der Soundbar an.
- B. Setzen Sie das Headset auf Ihren Kopf.

⑤

Ausführen der ADAPTiQ-Audiokalibrierung



- A. Drücken Sie auf der SoundTouch 300-Fernbedienung **8**.
 - B. Halten Sie **8** gedrückt, bis  und  an der Soundbar grün leuchten.
- HINWEIS:** Halten Sie zum Umschalten zwischen den Sprachen  und  auf dem Navigationsfeld gedrückt.

BOSE SOUNDBAR 500, BOSE SOUNDBAR 700, BOSE SMART SOUNDBAR 300

①

Plaats de basmodule

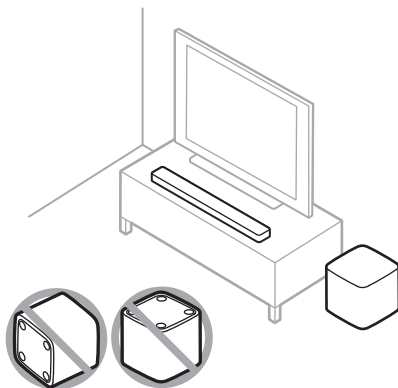

Plaats op een afstand van ten minste 30-90 cm van andere draadloze apparatuur.

②

Configureer met behulp van de Bose Music-app

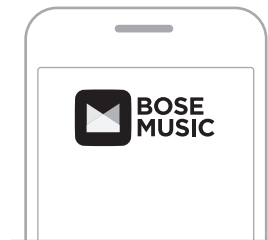

- Tik in het scherm **Mijn Bose** van de Bose Music-app op uw soundbar.
- Tik op de afbeelding van de soundbar in de rechterbenedenhoek van het scherm.
- Tik op **Instellingen** > **Extra luidsprekers** > **Bose extra luidsprekers toevoegen**.

Kent u de Bose Music-app nog niet?

Download de app en volg de instructies in de app om uw soundbar en basmodule te configureren.

BOSE TV SPEAKER (OF ALTERNATIEVE BEDRADE INSTALLATIE VOOR SOUNDBARS):

①

Plaats de basmodule

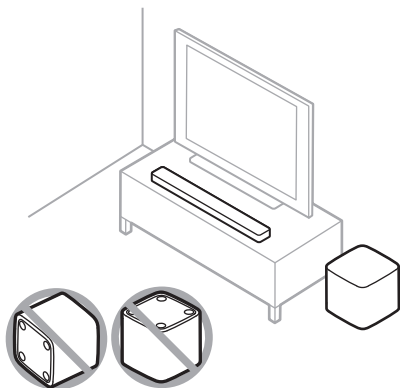

Plaats op een afstand van ten minste 30-90 cm van andere draadloze apparatuur.

②

Sluit de basmodule aan op een stopcontact

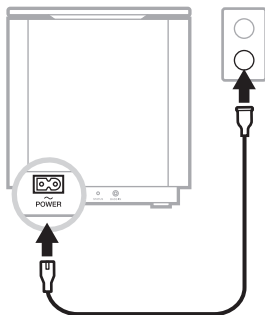

Zodra de basmodule is aangesloten, wordt deze ingeschakeld.

③

Sluit de basmodule aan op de luidspreker

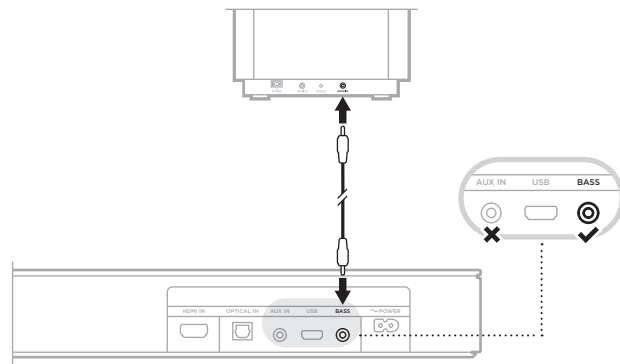

Sluit een audiokabel van 3,5 mm (niet bijgeleverd) aan op de aansluiting **BASS IN** op de basmodule en de aansluiting **BASS** (niet de aansluiting **AUX IN**) op de luidspreker.

OPMERKING: Als u geen audiokabel van 3,5 mm hebt, gaat u naar worldwide.Bose.com/Support/BASS700 om er een aan te schaffen. De kabel die daar verkrijgbaar is, heeft een lengte van 4,5 meter. U kunt ook naar een plaatselijke elektronikawinkel gaan.

SOUNDTOUCH 300 SOUNDBAR

①

Plaats de basmodule

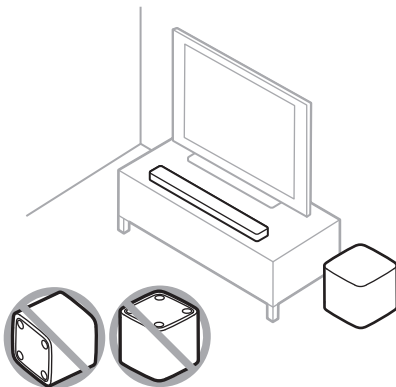

Plaats op een afstand van ten minste 30-90 cm van andere draadloze apparatuur.

②

Sluit de basmodule aan op een stopcontact

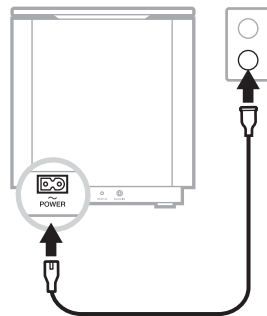



Zodra de basmodule is aangesloten, wordt deze ingeschakeld.

③

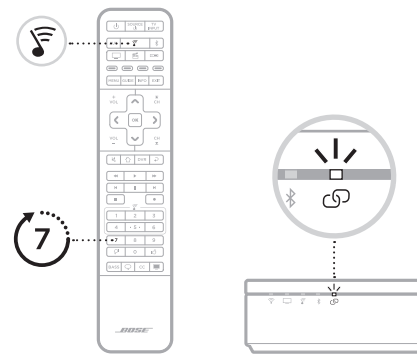
Verbind de basmodule met de soundbar



- Druk op de afstandsbediening van de SoundTouch 300 op .
- Houd 7 ingedrukt totdat  op de soundbar wit knippert. Wanneer de basmodule verbinding maakt, hoort u een toon en brandt  wit.

OPMERKING: Verbinding maken kan een paar minuten duren.

④

Configureer de ADAPTiQ-audiokalibratie

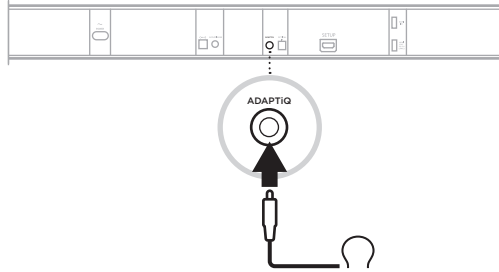



- A. Sluit de ADAPTiQ-headset (bijgeleverd bij de soundbar) aan op de aansluiting ADAPTiQ op de soundbar.
- B. Zet de headset op.

⑤

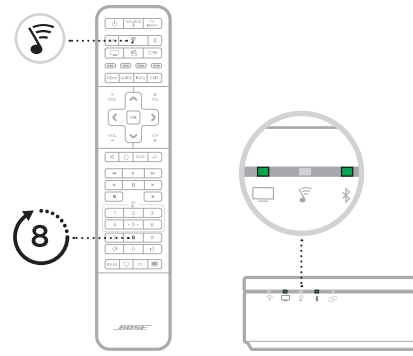
Voer de ADAPTiQ-audiokalibratie uit



- A. Druk op de afstandsbediening van de SoundTouch 300 op .
 - B. Houd 8 ingedrukt totdat  en  op de soundbar groen branden.
- OPMERKING:** Druk op ^ en v op het navigatiepaneel om door de talen te bladeren.

BOSE SOUNDBAR 500, BOSE SOUNDBAR 700, BOSE SMART SOUNDBAR 300

①

Colocación del módulo de bajos

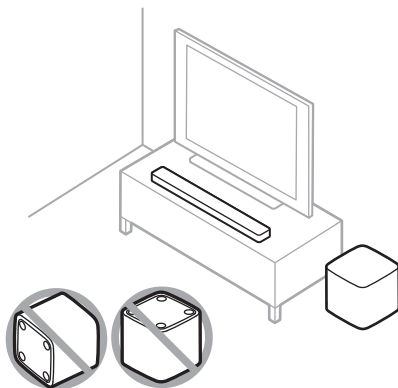

Mantener a una distancia de 0,3 a 0,9 m de otros equipos inalámbricos.

②

Configurar usando la aplicación Bose Music

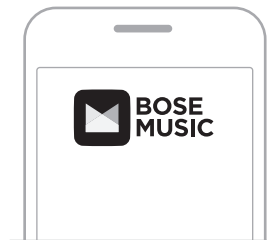

- En la aplicación Bose Music, en la pantalla **Mi Bose**, toque la barra de sonido.
- Toque la imagen de la barra de sonido en la esquina inferior derecha de la pantalla.
- Toque **Configuración** > **Altavoces accesorios** > **Agregar altavoces accesorios Bose**.

¿Es la primera vez que usa la aplicación Bose Music?

Descargue la aplicación y siga las instrucciones de la aplicación para configurar la barra de sonido y el módulo de bajos.

BOSE TV SPEAKER (O UNA CONFIGURACIÓN ALTERNATIVA CON CABLE PARA BARRAS DE SONIDO)

①

Colocación del módulo de bajos

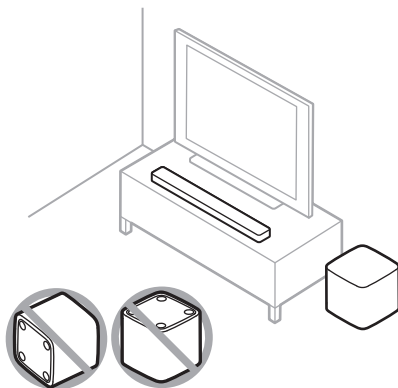

Mantener a una distancia de 0,3 a 0,9 m de otros equipos inalámbricos.

②

Conectar el módulo de bajos a la fuente de alimentación

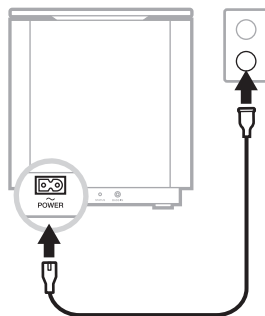

Una vez conectado, el módulo de bajos se enciende.

③

Conectar el módulo de bajos al altavoz

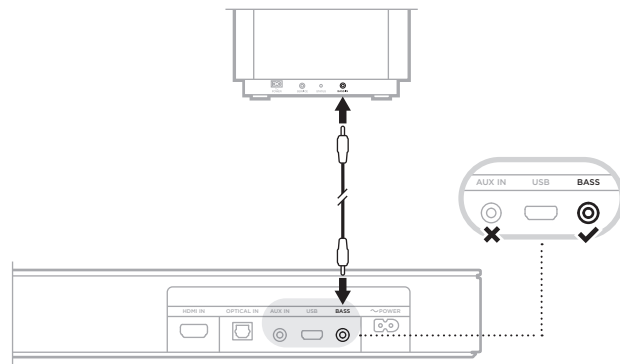

Conecte un cable de audio de 3,5 mm (no suministrado) al conector **BASS IN** del módulo de bajos y al conector **BASS** del altavoz (no al conector **AUX IN**).

NOTA: Si no tiene un cable de audio de 3,5 mm, visite worldwide.Bose.com/Support/BASS700 para adquirir un cable de 4,5 o vaya a una tienda de electrónica.

BARRA DE SONIDO SOUNDTOUCH 300

①

Colocación del módulo de bajos

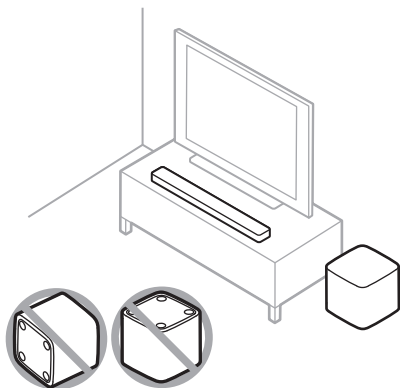

Mantener a una distancia de 0,3 a 0,9 m de otros equipos inalámbricos.

②

Conectar el módulo de bajos a la fuente de alimentación

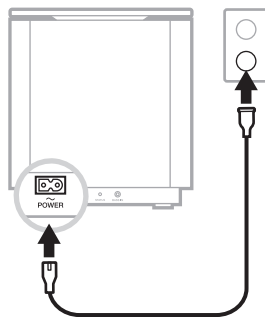



Una vez conectado, el módulo de bajos se enciende.

③

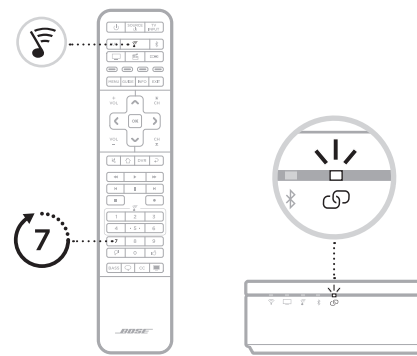
Conectar el módulo de bajos a la barra de sonido



- En el control remoto de SoundTouch 300, presione .
- Mantenga presionado 7 hasta que  en la barra de sonido parpadee de color blanco.

Una vez se conecta el módulo de bajos, se oye un tono y  se ilumina de color blanco.

NOTA: La conexión puede tardar varios minutos.

④

Configurar la calibración de audio ADAPTiQ

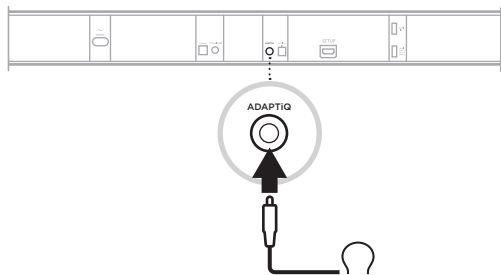



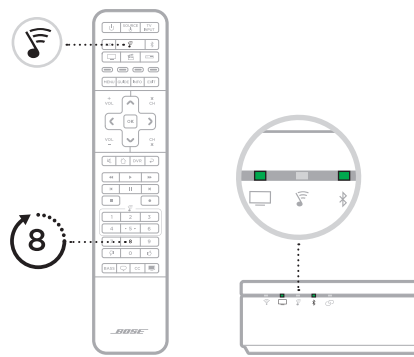

- A. Conecte los auriculares ADAPTiQ (incluidos con la barra de sonido) al conector ADAPTiQ de la barra de sonido.
- B. Colóquese los auriculares.

⑤

Ejecutar la calibración de audio ADAPTiQ



- A. En el control remoto de SoundTouch 300, presione .
- B. Mantenga presionado 8 hasta que  y  en la barra de sonido se iluminen de color verde.

NOTA: Para cambiar entre los distintos idiomas, presione  y  en el panel de navegación.

BOSE SOUNDBAR 500, BOSE SOUNDBAR 700, BOSE SMART SOUNDBAR 300

①

Sijoita bassoyksikkö.

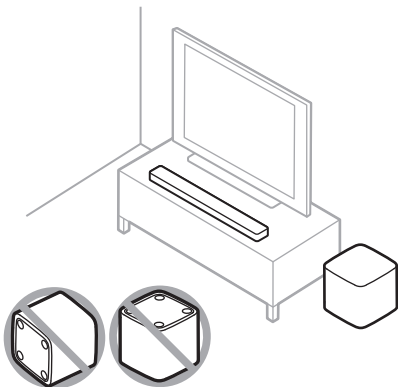

Pidä vähintään 0,3–0,9 metrin etäisyys muihin langattomiin laitteisiin.

②

Määritä Bose Music -sovelluksella.

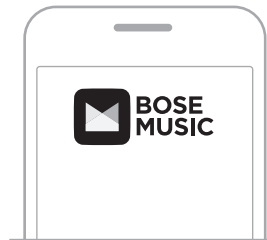

- A. Napauta soundbaria Bose Music -sovelluksen **My Bose** -näytössä.
- B. Napauta soundbarin kuvaa näytön oikeassa alakulmassa.
- C. Valitse **Asetukset** > **Lisäkaiuttimet** > **Lisää Bose-lisäkaiuttimet**.

Etkö ole ennen käyttänyt Bose Music -sovellusta?

Lataa sovellus ja määritä soundbar ja bassoyksikkö noudattamalla sovelluksen ohjeita.

BOSE TV SPEAKER (TAI SOUNDBARIN VAIHTOEHTOINEN LIITÄNTÄ JOHDOLLA)

①

Sijoita bassoyksikkö.

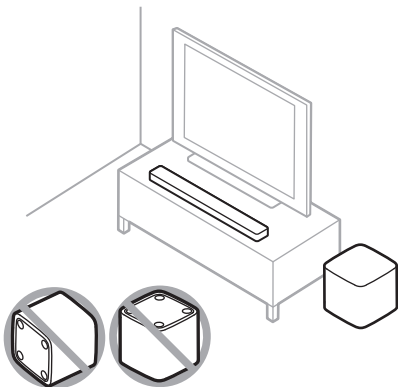

Pidä vähintään 0,3–0,9 metrin etäisyys muihin langattomiin laitteisiin.

②

Kytke bassoyksikkö verkkovirtaan.

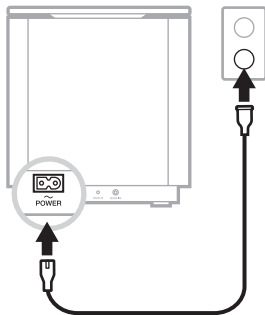

Bassoyksikkö käynnistyy.

③

Yhdistä bassoyksikkö kaiuttimeen.

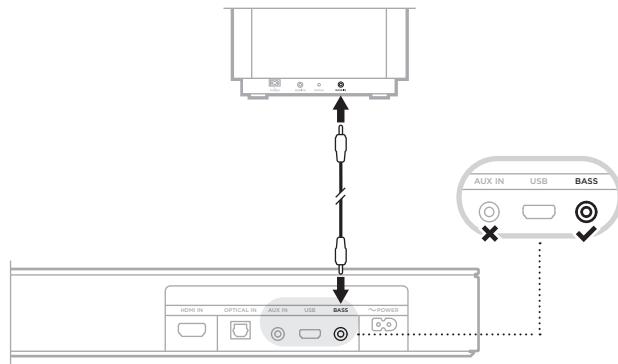

Liitä 3,5 mm:n äänijohto (ei sisälly toimitukseen) bassoyksikön **BASS IN**-liitintään ja kaiuttimen **BASS**-liitintään (ei **AUX IN**-liitintään).

HUOMAUTUS: Jos sinulla ei ole 3,5 mm:n äänijohtoa, voit tilata 4,5 m:n pituisen johdon osoitteesta worldwide.bose.com/Support/BASS700 tai ostaa sen mistä tahansa elektroniikkaliikkeestä.

SOUNDTOUCH 300 SOUNDBAR

①

Sijoita bassoyksikkö.

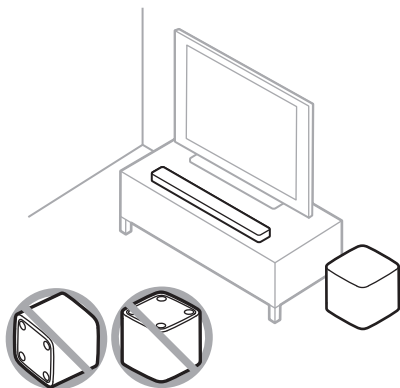

Pidä vähintään 0,3-0,9 metrin etäisyys muihin langattomiin laitteisiin.

②

Kytke bassoyksikkö verkkovirtaan.

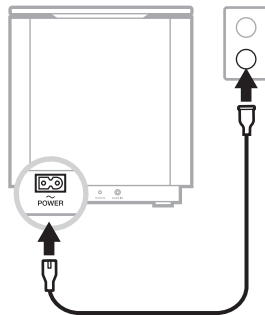

Bassoyksikkö käynnistyy.

③

Yhdistä bassoyksikkö soundbariin.

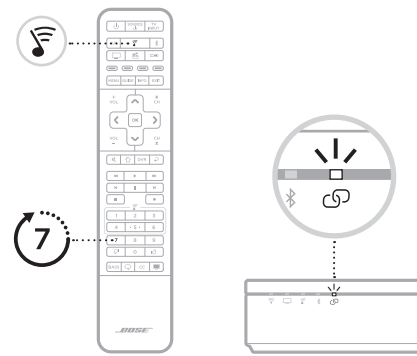

A. Paina SoundTouch 300 -kaukosäätimen painiketta .

B. Pidä 7 painettuna, kunnes soundbarin  alkaa vilkkua valkoisena.

Kun bassoyksikkö muodostaa yhteyden, kuuluu äänimerkki ja  syttyy valkoisena.

HUOMAUTUS: Yhdistäminen voi kestää useita minutteja.

④

Valmistele ADAPTiQ-äänenkalibroitijärjestelmä.

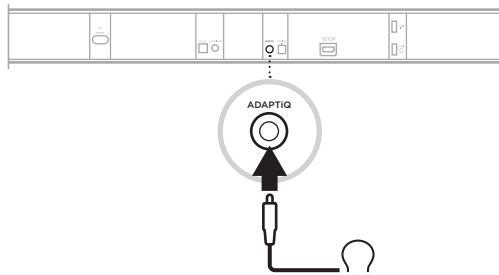



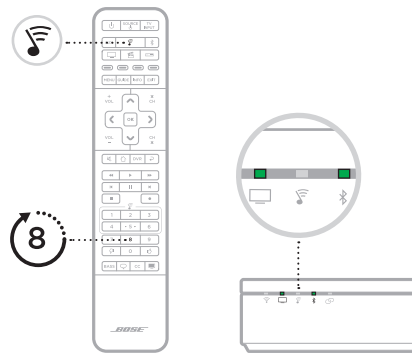

- A. Liitä ADAPTiQ-kuulokkeet (toimitetaan soundbarin mukana) soundbarin ADAPTiQ-liitäntään.
- B. Aseta kuulokkeet päähäsi.

⑤

Suorita ADAPTiQ-äänenkalibrointi.



- A. Paina SoundTouch 300 -kaukosäätimen painiketta .
 - B. Pidä 8 painettuna, kunnes soundbarin  ja  syttyvät vihreinä.
- HUOMAUTUS:** Voit selata kieliä painamalla siirtymistyydyn painikkeita  ja .

BOSE SOUNDBAR 500, BOSE SOUNDBAR 700, BOSE SMART SOUNDBAR 300

①

Positionnement du module de basses

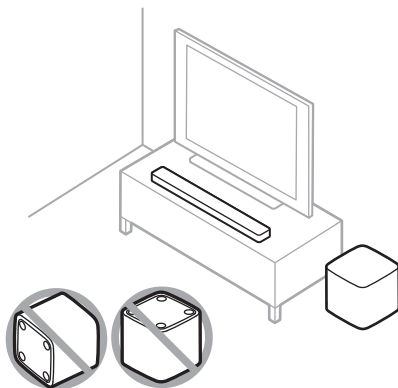

Éloignez la barre de son de 0,3 à 0,9 m de tout autre appareil sans fil.

②

Configuration à l'aide de l'application Bose Music

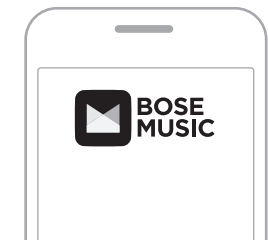

- Dans l'application Bose Music, appuyez sur votre barre de son dans l'écran **Mon Bose**.
- Appuyez sur l'image représentant la barre de son située dans l'angle inférieur droit de l'écran.
- Appuyez sur **Paramètres** > **Enceintes accessoires** > **Ajouter des enceintes accessoires Bose**.

Vous découvrez l'application Bose Music ?

Téléchargez l'application et suivez les instructions pour configurer votre barre de son et votre module de basses.

BOSE TV SPEAKER (OU CONFIGURATION CÂBLÉE ALTERNATIVE POUR BARRES DE SON)

①

Positionnement du module de basses

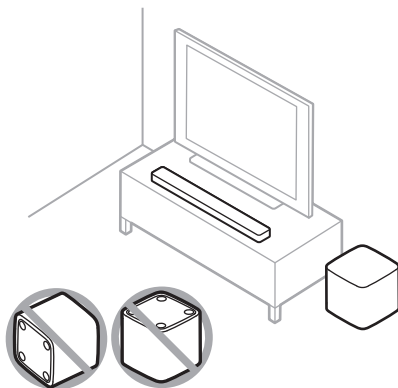

Éloignez la barre de son de 0,3 à 0,9 m de tout autre appareil sans fil.

②

Raccordement du module de basses à la prise secteur

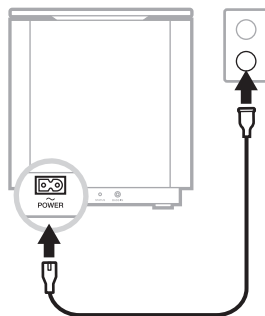

Une fois connecté, le module de basses se met sous tension.

③

Raccordement du module de basses à l'enceinte

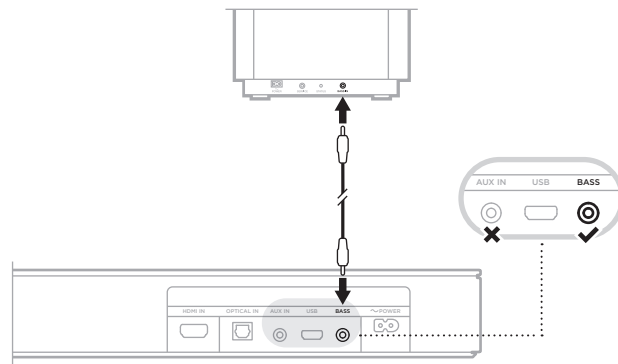

Raccordez un câble audio de 3,5 mm (non fourni) au connecteur **BASS IN** du module de basses et au connecteur **BASS** de l'enceinte (et non pas au connecteur **AUX IN**).

REMARQUE : si vous n'avez pas de câble audio de 3,5 mm, rendez-vous sur worldwide.Bose.com/Support/BASS700 pour acheter un câble de 4,5 m. Vous pouvez également acheter cette pièce dans un magasin d'électronique grand public.

BARRE DE SON SOUNDTOUCH 300

①

Positionnement du module de basses

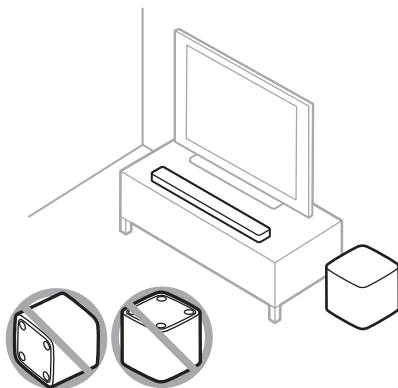

Éloignez la barre de son de 0,3 à 0,9 m de tout autre appareil sans fil.

②

Raccordement du module de basses à la prise secteur

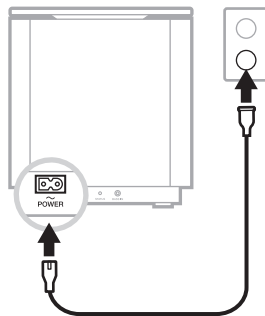



Une fois connecté, le module de basses se met sous tension.

③

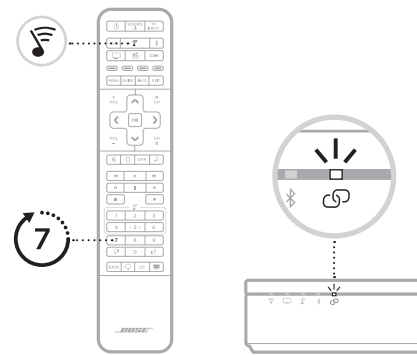
Raccordement du module de basses à la barre de son



- Sur la télécommande de votre barre de son SoundTouch 300, appuyez sur .
- Maintenez la touche 7 enfoncée jusqu'à ce que l'indication  clignote en blanc sur la barre de son.
Une fois le module de basses connecté, vous entendez une tonalité et  s'allume en blanc.

REMARQUE : la connexion peut prendre plusieurs minutes.

④

Configuration de l'étalonnage audio ADAPTiQ

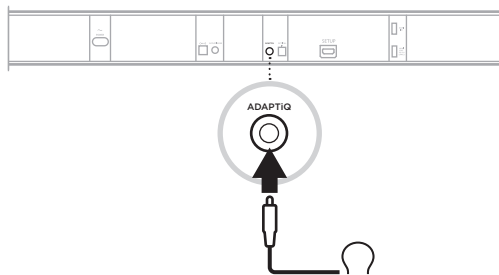



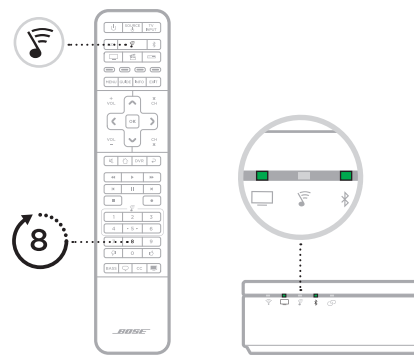

- A. Raccordez le casque ADAPTiQ (fourni avec la barre de son) au connecteur ADAPTiQ de la barre de son.
- B. Placez le casque sur votre tête.

⑤

Exécution du calibrage audio ADAPTiQ



- A. Sur la télécommande de votre barre de son SoundTouch 300, appuyez sur .
- B. Maintenez la touche 8 enfoncée jusqu'à ce que les indications  et  clignotent en vert sur la barre de son.

REMARQUE : pour parcourir les langues, appuyez sur les touches  et  du pavé de navigation.

BOSE SOUNDBAR 500, BOSE SOUNDBAR 700, BOSE SMART SOUNDBAR 300

①

Collocare il modulo dei bassi

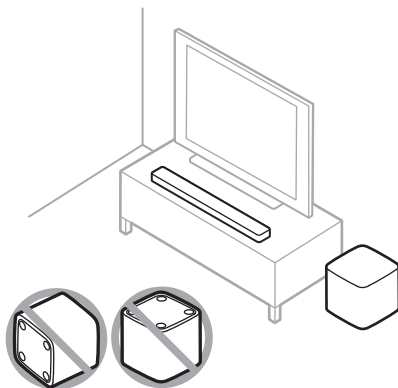

Posizionare l'unità a una distanza minima di 30-90 cm da altre apparecchiature wireless.

②

Impostazione mediante l'app Bose® Music

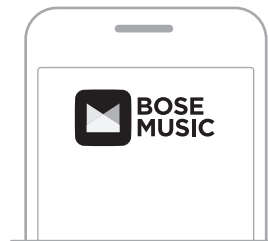

- Se si utilizza l'app Bose Music, dalla schermata **My Bose** fare clic sulla soundbar in uso.
- Fare clic sull'immagine della soundbar, nell'angolo inferiore destro della schermata.
- Selezionare **Impostazioni** > **Diffusori ausiliari** > **Aggiungi diffusori ausiliari Bose**.

Cosa fare se non si conosce l'app Bose Music?

Scaricare l'app e seguire le istruzioni fornite per configurare soundbar e modulo bassi.

BOSE TV SPEAKER (O CONFIGURAZIONE CABLATA ALTERNATIVA PER LE SOUNDBAR)

①

Collocare il modulo dei bassi

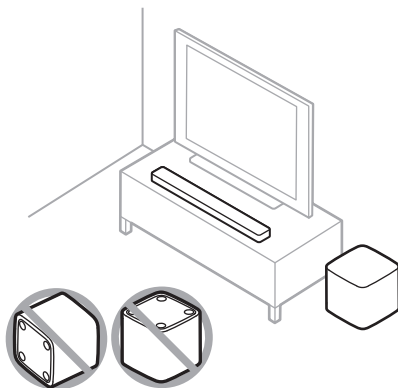

Posizionare l'unità a una distanza minima di 30-90 cm da altre apparecchiature wireless.

②

Collegare il modulo bassi all'alimentazione

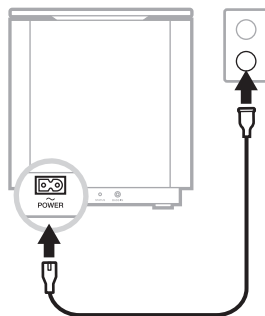

Una volta collegato, il modulo bassi si accende.

③

Collegare il modulo bassi al diffusore

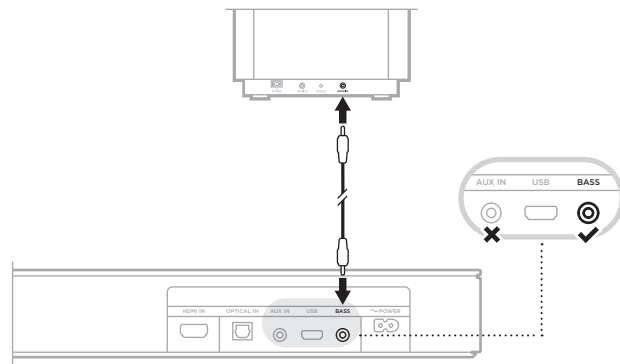

Collegare un cavo audio da 3,5 mm (non fornito) al connettore **BASS IN** del modulo bassi e al connettore **BASS** del diffusore (non al connettore **AUX IN**).

NOTA: se non si dispone di un cavo audio da 3,5 mm, visitare worldwide.Bose.com/Support/BASS700 per acquistare un cavo da 4,5 m oppure comprarlo in un negozio di elettronica.

SOUNDBAR SOUNDTOUCH 300

①

Collocare il modulo dei bassi

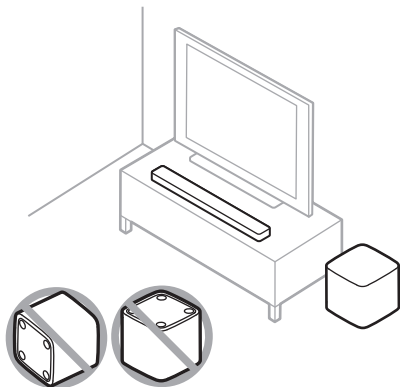

Posizionare l'unità a una distanza minima di 30-90 cm da altre apparecchiature wireless.

②

Collegare il modulo bassi all'alimentazione

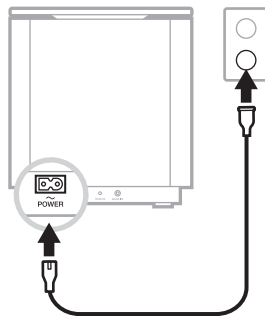

Una volta collegato, il modulo bassi si accende.

③

Collegare il modulo bassi alla soundbar

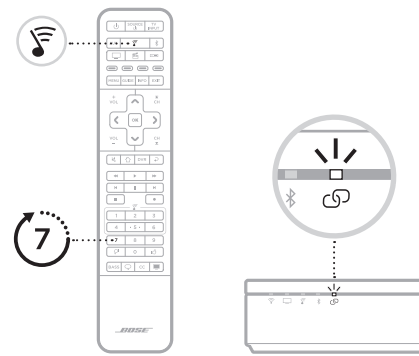

A. Sul telecomando della SoundTouch 300, premere .

B. Premere e tenere premuto 7 fino a quando il simbolo  sulla soundbar non lampeggia in bianco.

Non appena il modulo bassi si collega, si attiva un segnale acustico e il simbolo  si illumina in bianco.

NOTA: la connessione potrebbe richiedere diversi minuti.

④

Impostare la calibrazione audio ADAPTiQ

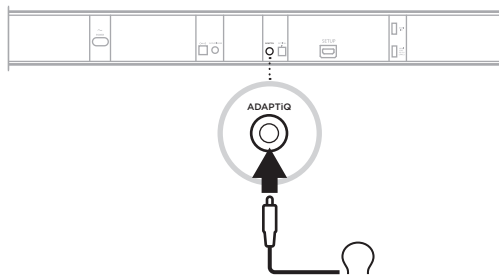



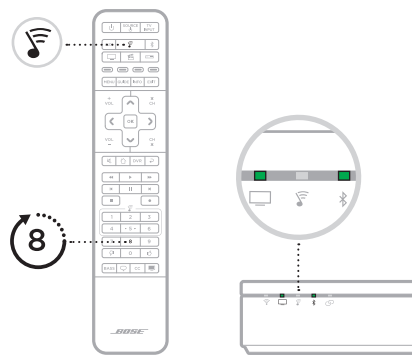

- A. Collegare le cuffie ADAPTiQ (accluse alla soundbar) al connettore ADAPTiQ della soundbar.
- B. Indossare le cuffie.

⑤

Eeguire la calibrazione audio ADAPTiQ



- A. Sul telecomando della SoundTouch 300, premere .
- B. Premere e tenere premuto 8 finché i simboli  e  sulla soundbar non lampeggiano in verde.

NOTA: per scorrere le lingue disponibili, premere  e  sul pad di navigazione.

BOSE SOUNDBAR 500, BOSE SOUNDBAR 700, BOSE SMART SOUNDBAR 300

①

Helyezze el a mélyhangmodult

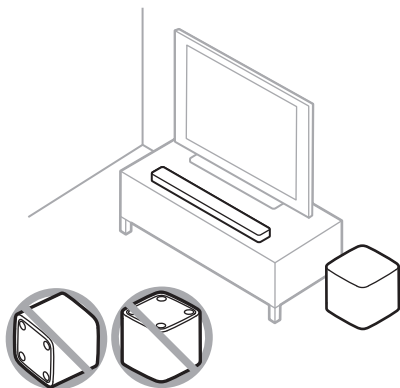

Helyezze legalább 0,3-0,9 méterre a többi vezeték nélküli eszköztől.

②

Beállítás a Bose zenei alkalmazás segítségével



- A Bose zenei alkalmazásban koppintson a **Bose készülékem** képernyőn a hangszugárzóra.
- Koppintson a képernyő jobb alsó sarkában lévő hangszugárzóikonra.
- Koppintson a **Beállítások > Kiegészítő hangszórók > Bose kiegészítő hangszórók hozzáadása** lehetőségre.

Először használja a Bose zenei alkalmazást?

Töltse le az alkalmazást, és a hangszugárzó és a mélyhangmodul beállításához kövesse az alkalmazás utasításait.

BOSE TV SPEAKER (VAGY ALTERNATÍV VEZETÉKES KAPCSOLAT HANGSUGÁRZÓKHOZ)

①

Helyezze el a mélyhangmodult

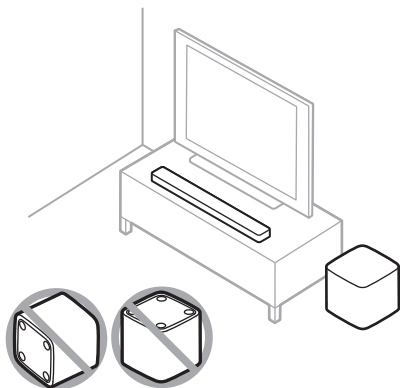

Helyezze legalább 0,3-0,9 méterre a többi vezeték nélküli eszköztől.

②

Csatlakoztassa áramforráshoz a mélyhangmodult

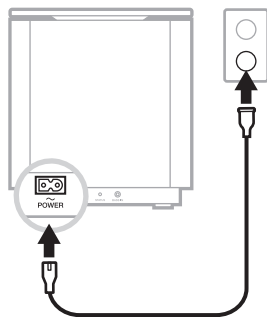

A csatlakoztatást követően a mélyhangmodul bekapcsol.

③

Csatlakoztassa a mélyhangmodult a hangszóróhoz

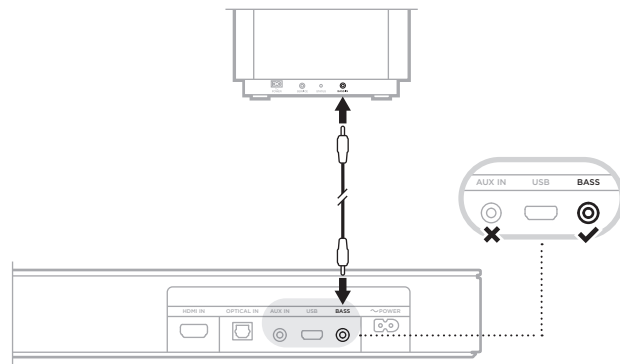

Csatlakoztasson egy (külön beszerezendő) 3,5 mm-es audiokábelt a mélyhangmodul **BASS IN** aljzatához és a hangszóró **BASS** aljzatához (ne az **AUX IN** aljzathoz).

MEGJEGYZÉS: Ha nem rendelkezik 3,5 mm-es audiokábellel, látogasson el a worldwide.Bose.com/Support/BASS700 címre vagy egy helyi elektromos szaküzletbe, és vásároljon egy 4,5 méteres kábelt.

SOUNDTOUCH 300 HANGSUGÁRZÓ

①

Helyezze el a mélyhangmodult

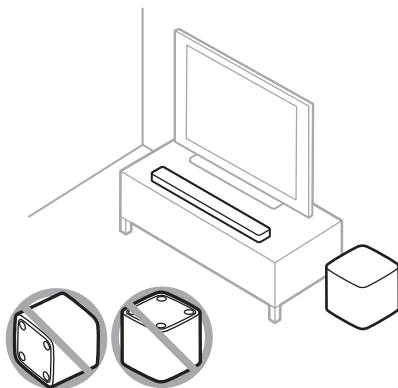

Helyezze legalább 0,3-0,9 méterre a többi vezeték nélküli eszköztől.

②

A mélyhangmodul áramforráshoz csatlakoztatása

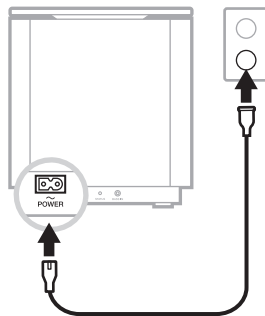



A csatlakoztatást követően a mélyhangmodul bekapcsol.

③

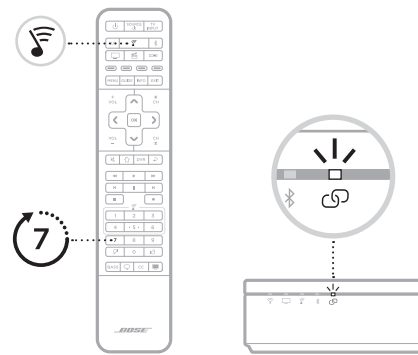
Csatlakoztassa a mélyhangmodult a hangsugárzóhoz



A. A SoundTouch 300 távvezérlőjén nyomja meg az  gombot.
B. Nyomja le és tartsa lenyomva a 7 gombot, amíg a hangsugárzó  jelzőfénye fehéren nem villog.

A mélyhangmodul kapcsolódását egy hangjelzés jelzi, és az  fény fehéren világít.

MEGJEGYZÉS: A csatlakoztatás néhány percre tart.

④

Állítsa be az ADAPTiQ hangkalibrációt

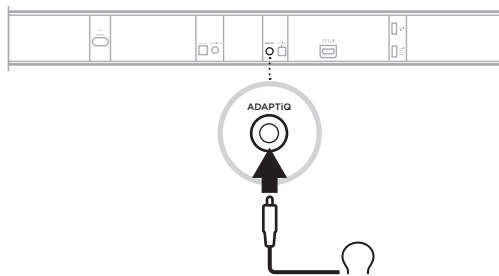



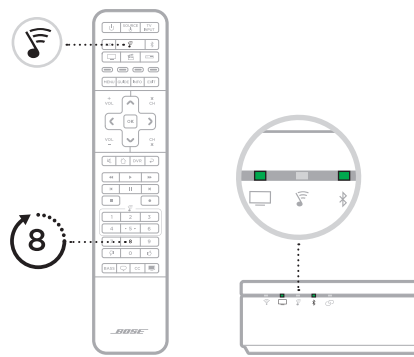

- A. Csatlakoztassa az ADAPTiQ fejhallgatót (a hangsugárzóhoz mellékelve) a hangsugárzó ADAPTiQ csatlakozójához.
- B. Tegye a fejhallgatót a fejére.

⑤

Futtassa le az ADAPTiQ hangkalibrációt



- A. A SoundTouch 300 távvezérlőjén nyomja meg az  gombot.
- B. Nyomja le, és tartsa lenyomva a 8 gombot, amíg a hangsugárzó  és  fénye zölden nem világít.

MEGJEGYZÉS: A nyelvek közötti váltáshoz nyomogassa a navigációs panel  és  gombjait.

BOSE SOUNDBAR 500, BOSE SOUNDBAR 700, BOSE SMART SOUNDBAR 300

①

Plassere bassmodulen

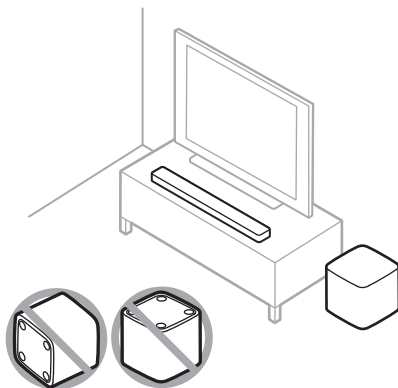

Plasser den minst 0,3–0,9 m borte fra annet trådløst utstyr.

②

Konfigurere med Bose Music-appen

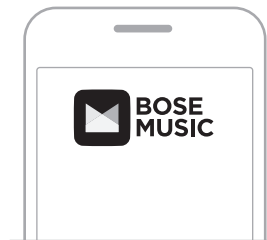

- I Bose Music-appen går du til skjermbildet **Min Bose** og trykker på lydplanken.
- Trykk på bildet med lydplanken nederste til høyre på skermen.
- Trykk på **Innstillinger** > **Tilbehørshøyttalere** > **Legg til Bose tilbehørshøyttalere**.

Har du ikke brukt Bose Music-appen tidligere?

Last ned appen og følg instruksjonene i den for å konfigurere lydplanken og bassmodulen.

BOSE TV SPEAKER (ELLER ALTERNATIV KABLET OPPSETT FOR LYDPLANKER)

①

Plassere bassmodulen

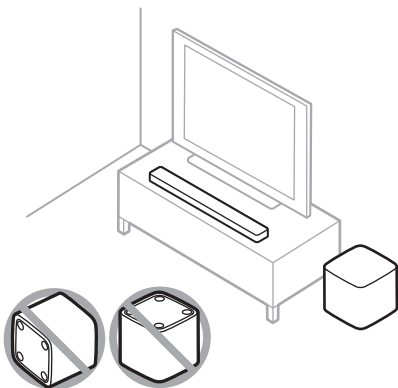

Plasser den minst 0,3–0,9 m borte fra annet trådløst utstyr.

②

Koble bassmodulen til strøm

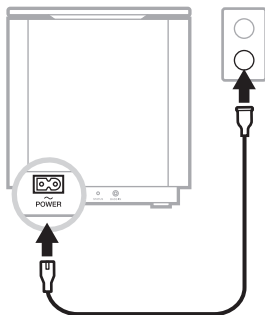

Bassmodulen slås på når den er tilkoblet.

③

Koble bassmodulen til høyttaleren

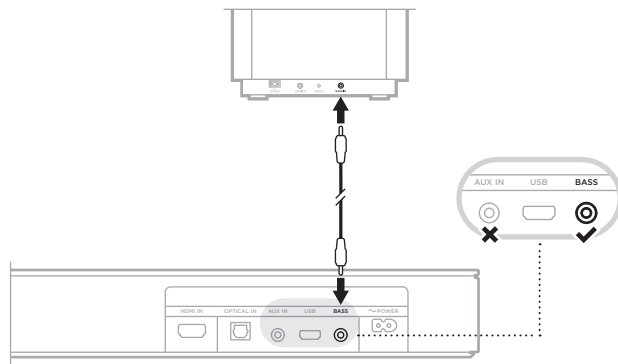

Koble en 3,5 mm lyd kabel (følger ikke med) til bassmodulens **BASS IN**-kontakt og høyttalerens **BASS**-kontakt (ikke **AUX IN**-kontakten).

MERKNAD: Hvis du ikke har en 3,5 mm lyd kabel, kan du gå til worldwide.Bose.com/Support/BASS700 for å kjøpe en 4,5 m (15 fot) kabel eller gå til din lokale elektronikkforhandler.

SOUNDTOUCH 300 SOUNDBAR

①

Plassere bassmodulen

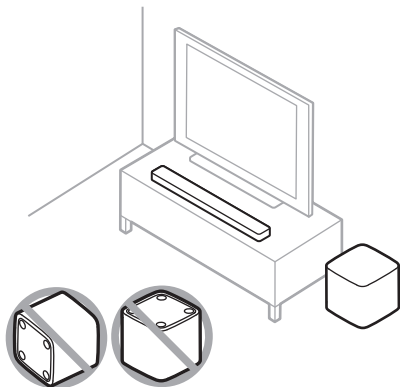

Plasser den minst 0,3–0,9 m borte fra annet trådløst utstyr.

②

Koble bassmodulen til strøm

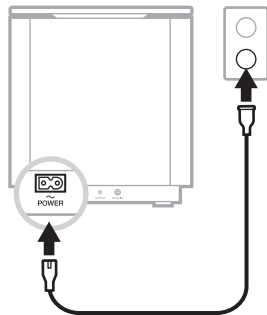



Bassmodulen slås på når den er tilkoblet.

③

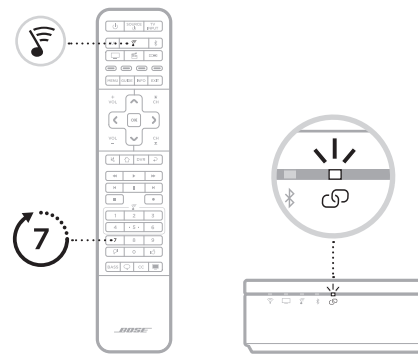
Koble bassmodulen til lydplanken



- A. Trykk på  på fjernkontrollen for SoundTouch 300.
- B. Trykk og hold inne 7 til  på lydplanken blinker hvitt. Når bassmodulen kobler til, spilles det av en tone og  lyser hvitt.

MERK: Tilkoblingen kan ta flere minutter.

④

Konfigurere ADAPTiQ-lydkalibreringen

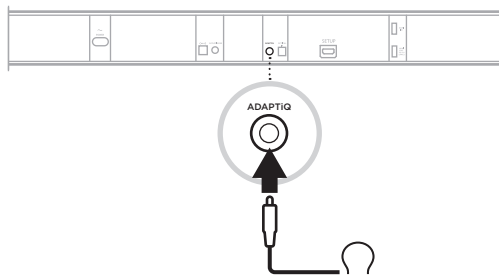



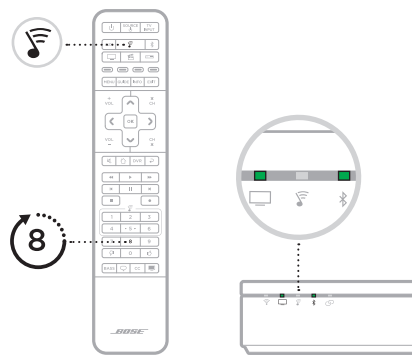

- A. Koble ADAPTiQ-hodetelefonene (følger med lydplanken) til ADAPTiQ-kontakten på lydplanken.
- B. Ta på deg hodetelefonene.

⑤

Kjøre ADAPTiQ-lydkalibreringen



- A. Trykk på  på fjernkontrollen for SoundTouch 300.
 - B. Trykk og hold inne 8 til  og  på lydplanken lyser grønt.
- MERK:** Du går gjennom språkene ved å trykke på  og  på navigasjonsplaten.

BOSE SOUNDBAR 500, BOSE SOUNDBAR 700, BOSE SMART SOUNDBAR 300

①

Wybór lokalizacji modułu basowego

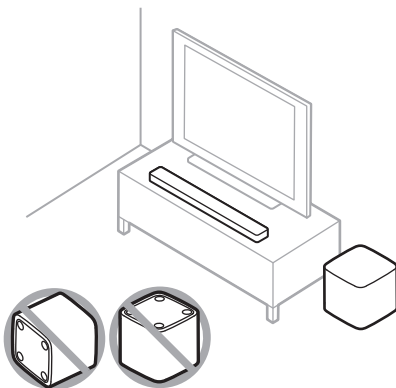

Zachowaj odstęp co najmniej 0,3-0,9 m od innych urządzeń bezprzewodowych.

②

Konfiguracja przy użyciu aplikacji Bose Music

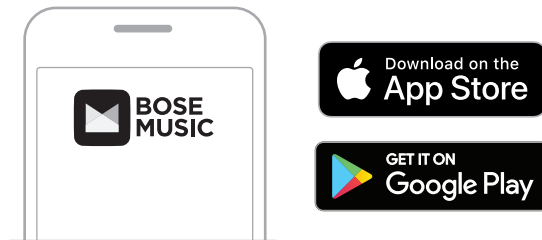

- W aplikacji Bose Music na ekranie **Moje Bose** naciśnij wpis swojego głośnika soundbar.
- Naciśnij ikonę głośnika soundbar w prawym dolnym rogu ekranu.
- Naciśnij **Ustawienia > Głośniki opcjonalne > Dodaj głośniki opcjonalne Bose**.

Nie masz jeszcze aplikacji Bose Music?

Aby skonfigurować głośnik soundbar i moduł basowy, pobierz aplikację i postępuj zgodnie z wyświetlanymi w niej instrukcjami.

GŁOŚNIK BOSE TV SPEAKER (LUB ALTERNATYWNA PRZEWODOWA KONFIGURACJA DLA GŁOŚNIKÓW SOUNDBAR)

①

Wybór lokalizacji modułu basowego

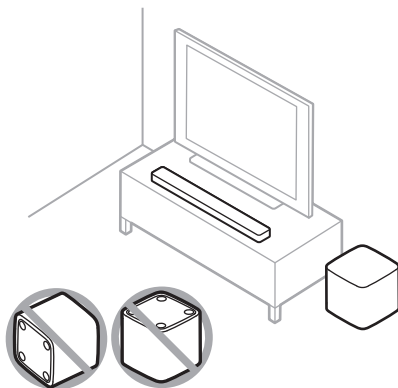

Zachowaj odstęp co najmniej 0,3-0,9 m od innych urządzeń bezprzewodowych.

②

Podłączanie modułu basowego do zasilania

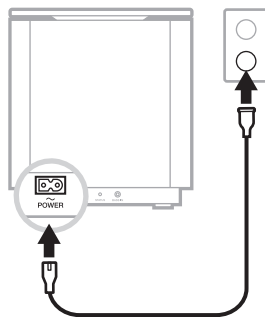

Po podłączeniu modułu basowego jego zasilanie jest włączone.

③

Podłączanie modułu basowego do głośnika soundbar

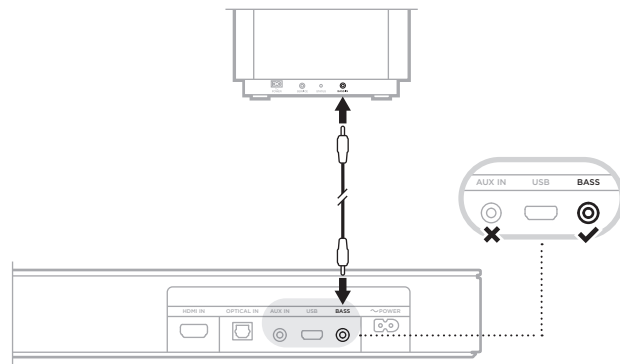

Podłącz przewód audio z wtyczką 3,5 mm (nieuwzględniony w pakiecie z produktem) do złącza **BASS IN** modułu basowego i złącza **BASS** (nie złącza **AUX IN**) głośnika.

UWAGA: Jeżeli nie masz przewodu audio z wtyczką 3,5 mm, zakup przewód 4,5 m w witrynie internetowej worldwide.bose.com/Support/BASS700 lub lokalnym sklepie z produktami elektronicznymi.

GŁOŚNIK SOUNDBAR SOUNDTOUCH 300

①

Wybór lokalizacji modułu basowego

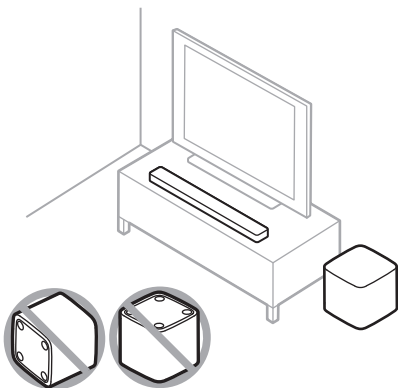

Zachowaj odstęp co najmniej 0,3-0,9 m od innych urządzeń bezprzewodowych.

②

Podłączanie modułu basowego do zasilania

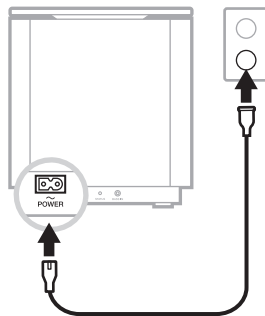



Po podłączeniu modułu basowego jego zasilanie jest włączane.

③

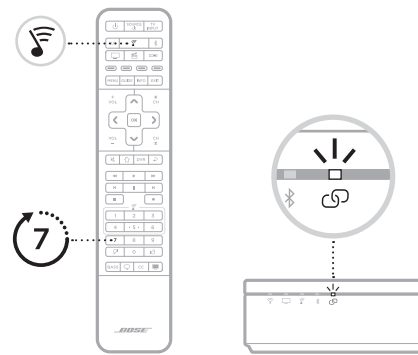
Podłączanie modułu basowego do głośnika soundbar



- Na pilocie zdalnego sterowania głośnika SoundTouch 300 naciśnij przycisk .
- Naciśnij przycisk 7 i przytrzymaj go do chwili, gdy biały wskaźnik  na głośniku soundbar zacznie migać.
Po podłączeniu modułu basowego zostanie odtworzony sygnał dźwiękowy, a biały wskaźnik  zostanie włączony.
UWAGA: Ustanawianie połączenia może trwać kilka minut.

④

Konfigurowanie kalibracji dźwięku ADAPTiQ

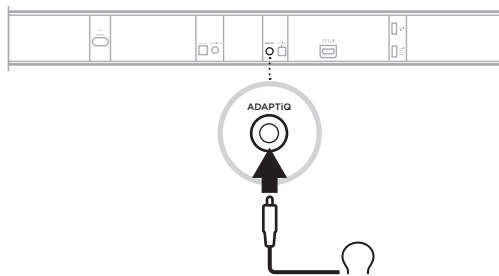



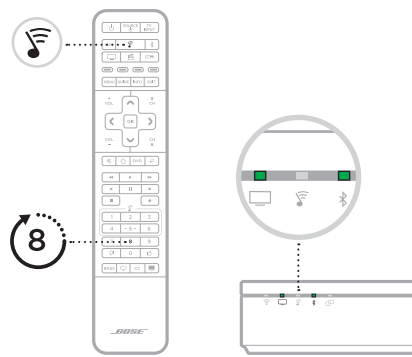

- A. Podłącz zestaw słuchawkowy ADAPTiQ (uwzględniony w pakiecie głośnika soundbar) do złącza ADAPTiQ głośnika soundbar.
- B. Załóż zestaw słuchawkowy.

⑤

Uruchamianie kalibracji dźwięku ADAPTiQ



- A. Na pilocie zdalnego sterowania głośnika SoundTouch 300 naciśnij przycisk .
- B. Naciśnij przycisk 8 i przytrzymaj go do chwili, gdy zielone wskaźniki  i  na głośniku soundbar zostaną włączone.

UWAGA: Aby zmienić wersję językową, należy użyć przycisków nawigacyjnych  i .

BOSE SOUNDBAR 500, BOSE SOUNDBAR 700, BOSE SMART SOUNDBAR 300

①

Posicionar o módulo de graves

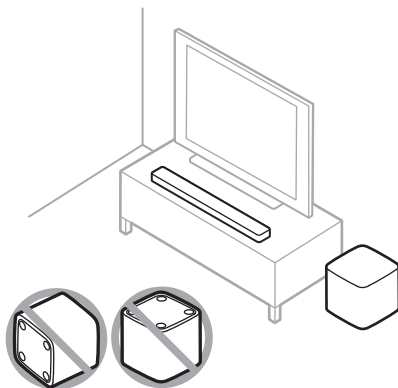

Mantenha uma distância de pelo menos 0,3 - 0,9 m de outros equipamentos sem fio.

②

Configurar usando o aplicativo Bose Music

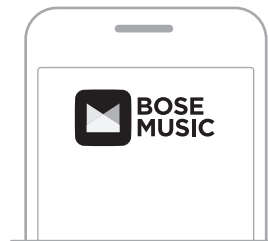

- No aplicativo Bose Music, na tela **Meu Bose**, toque em sua barra de som.
- Toque na imagem da barra de som no canto inferior direito da tela.
- Toque em **Configurações** > **Alto-falantes acessórios** > **Adicionar alto-falantes acessórios Bose**.

Novo no aplicativo Bose Music?

Baixe o aplicativo e siga as instruções dele para configurar a barra de som e o módulo de graves.

BOSE TV SPEAKER (OU CONFIGURAÇÃO ALTERNATIVA COM FIO PARA BARRAS DE SOM)

①

Posicionar o módulo de graves

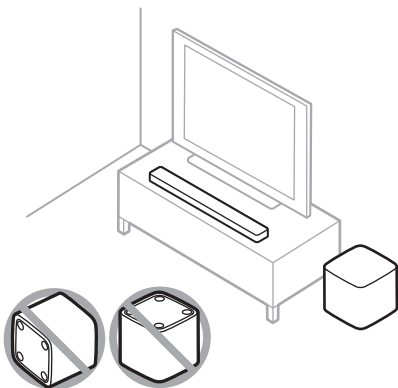

Mantenha uma distância de pelo menos 0,3 - 0,9 m de outros equipamentos sem fio.

②

Conectar o módulo de graves à alimentação

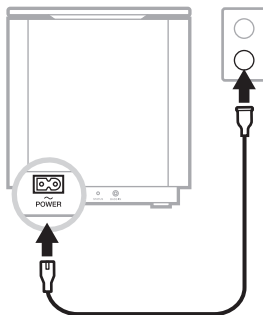

Uma vez conectado, o módulo de graves será ligado.

③

Conectar o módulo de graves ao alto-falante

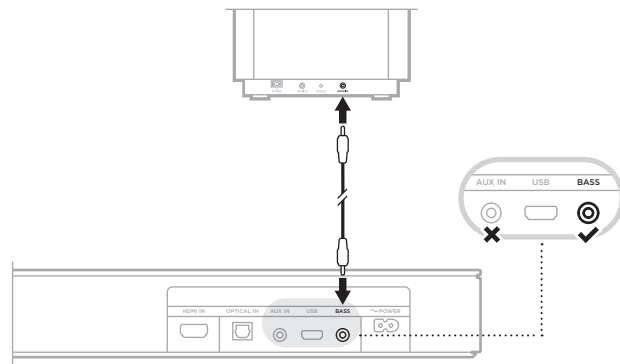

Conecte um cabo de áudio de 3,5 mm (não fornecido) ao conector **BASS IN** do módulo de graves e ao conector **BASS** do alto-falante (e não ao conector **AUX IN**).

OBSERVAÇÃO: Se você não tiver um cabo de áudio de 3,5 mm, visite worldwide.Bose.com/Support/BASS700 para comprar um cabo de 4,5 m ou vá até a loja de produtos eletrônicos da sua região.

BARRA DE SOM SOUNDTOUCH 300

①

Posicionar o módulo de graves

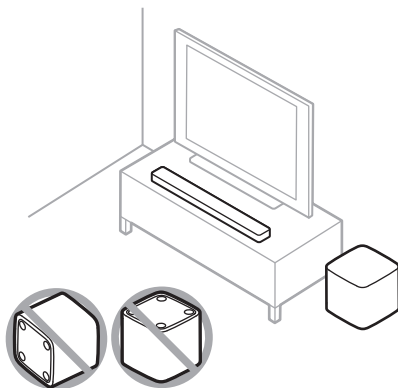

Mantenha uma distância de pelo menos 0,3 - 0,9 m de outros equipamentos sem fio.

②

Conectar o módulo de graves à alimentação

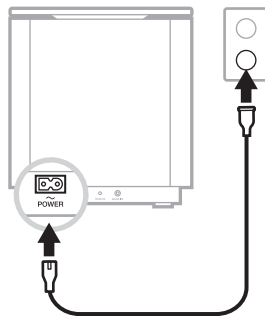

Uma vez conectado, o módulo de graves será ligado.

③

Conectar o módulo de graves à barra de som

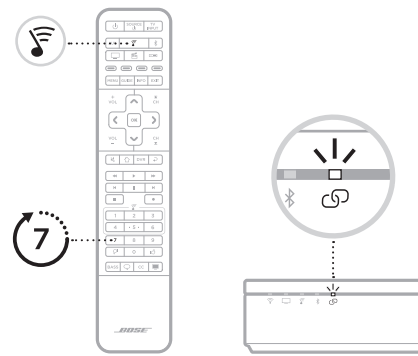

- A. No controle remoto do SoundTouch 300, pressione
- B. Pressione 7 por alguns segundos, até na barra de som piscar em branco.

Quando o módulo de graves se conectar, você ouvirá um som e acenderá em branco.

OBSERVAÇÃO: A conexão pode demorar vários minutos.

④

Configurar a calibração de áudio ADAPTiQ

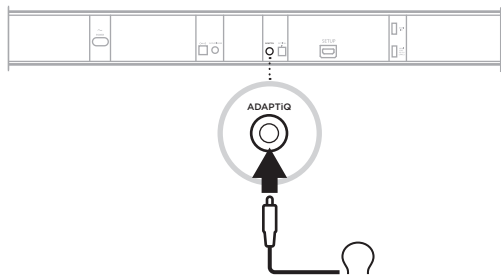



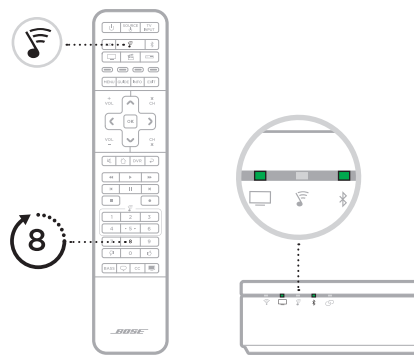

- A. Conecte o fone de ouvido ADAPTiQ (fornecido com a barra de som) ao conector ADAPTiQ da barra de som.
- B. Coloque o fone de ouvido em sua cabeça.

⑤

Executar a calibração de áudio ADAPTiQ



- A. No controle remoto do SoundTouch 300, pressione .
- B. Pressione 8 por alguns segundos, até  e  na barra de som acenderem em verde.

OBSERVAÇÃO: Para navegar entre os idiomas, pressione  e  no painel de navegação.

BOSE SOUNDBAR 500, BOSE SOUNDBAR 700, BOSE SMART SOUNDBAR 300

①

Placera basmodulen

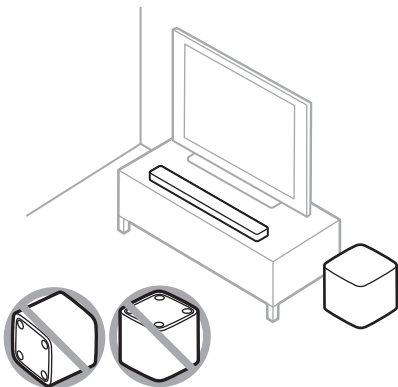

Se till att avståndet till annan trådlös utrustning är minst 0,3 - 0,9 m.

②

Installation via Bose Music-appen

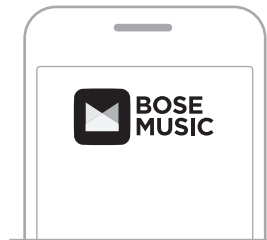

- Knacka på soundbarhögtalaren i Bose Music-appen från **My Bose**-skärmen.
- Tryck på bilden av soundbarhögtalaren i skärmens nedre högra hörn.
- Knacka på **Inställningar > Accessory Speakers > Add Bose Accessory Speakers**.

Första gången med Bose Music-appen?

Ladda ner appen och följ instruktionerna för att ställa in soundbarhögtalaren och basmodulen.

BOSE TV SPEAKER (ELLER ALTERNATIV KABELANSLUTEN INSTÄLLNING FÖR SOUNDBARHÖGTALARE)

①

Placera basmodulen

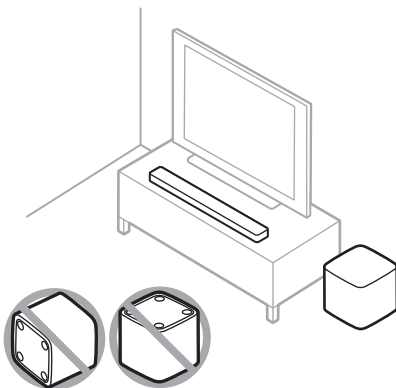

Se till att avståndet till annan trådlös utrustning är minst 0,3 - 0,9 m.

②

Anslut basmodulen till ett eluttag

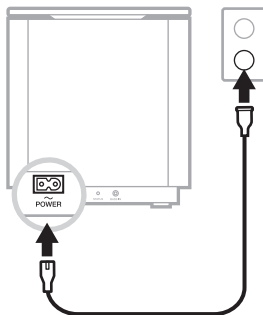

Väl ansluten startar basmodulen.

③

Anslut basmodulen till högtalaren

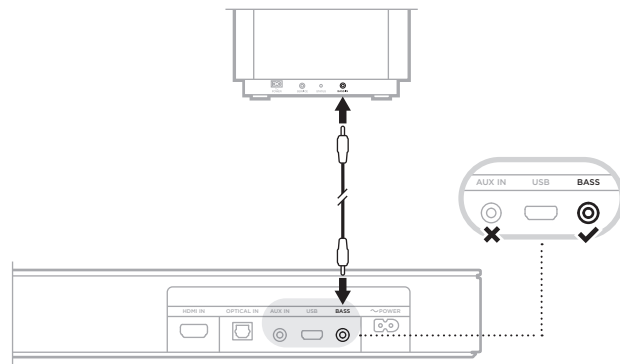

Anslut en 3,5 mm-ljudkabel (medföljer inte) till basmodulens **BASS IN**-kontakt och högtalarens **BASS**-kontakt (inte **AUX IN**-kontakten).

OBS! Om du inte har en 3,5 mm-ljudkabel, kan du köpa en kabel på 4,5 m på worldwide.Bose.com/Support/BASS700 eller i en lokal elektronikbutik.

SOUNDTOUCH 300 SOUNDBARHÖGTALARE

①

Placera basmodulen

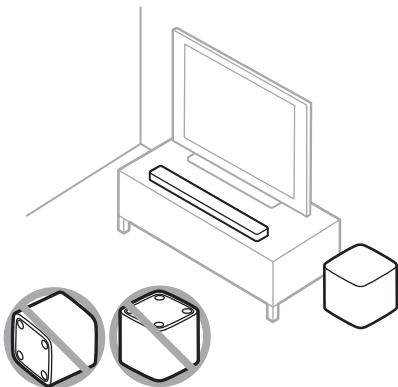

Se till att avståndet till annan trådlös utrustning är minst 0,3 - 0,9 m.

②

Anslut basmodulen till ett eluttag

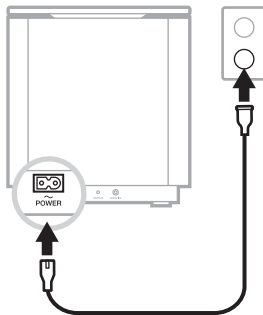



Väl ansluten startar basmodulen.

③

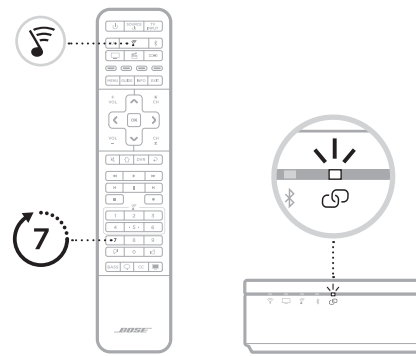
Anslut basmodulen till soundbarhögtalaren



- A. Använd fjärrkontrollen till SoundTouch 300 och tryck på .
- B. Tryck ned 7 tills  på soundbarhögtalaren blinkar vitt.
När basmodulen är ansluten hörs en ton och  lyser vitt.
OBS! Anslutningen kan ta flera minuter.

④

Förbered för ADAPTiQ-ljudkalibrering

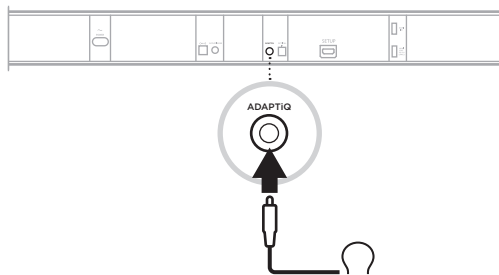



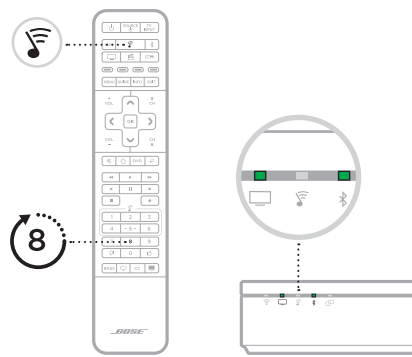

- A. Anslut ADAPTiQ-headsetet (medföljer soundbarhögtalaren) till soundbarhögtalarens ADAPTiQ-kontakt.
- B. Sätt headsetet på huvudet.

⑤

Kör ADAPTiQ-ljudkalibrering



- A. Använd fjärrkontrollen på SoundTouch 300 och tryck på .
 - B. Tryck ned 8 tills  och  på soundbarhögtalaren lyser grönt.
- OBS!** Välj rätt språk genom att trycka på  och  på navigeringsplattan.



global.bose.com/Support



810743-0050