

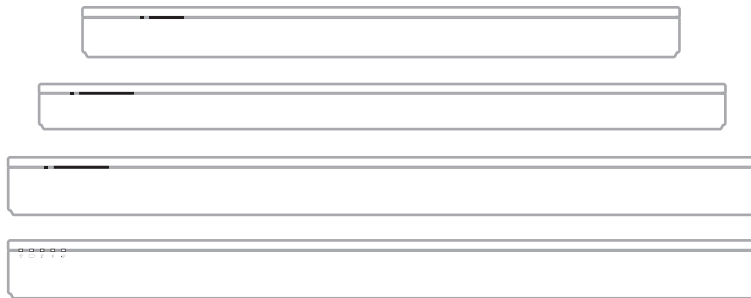

**SURROUND SPEAKERS**

## START HERE



### Choose your setup method

Your setup method depends on which soundbar you have.

**Bose Soundbar 500, Bose Soundbar 700, or**

**Bose Smart Soundbar 300:** See method 1.

**SoundTouch 300 soundbar:** See method 2.

## METHOD 1

BOSE SOUNDBAR 500, BOSE SOUNDBAR 700, BOSE SMART SOUNDBAR 300



### Set up using the Bose Music app

- a. In the Bose Music app, from the My Products screen, select your soundbar.
- b. Go to the Settings menu to add your surround speakers.

---

#### New to Bose Music app?

Download the app and follow the app instructions to set up your soundbar and surround speakers.

## METHOD 2

### SOUNDTOUCH 300 SOUNDBAR

①

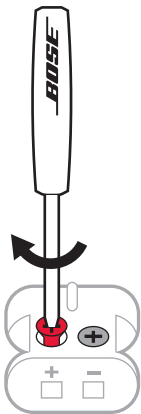

#### Connect your adapters

- Insert the color-coded speaker cable wires into their corresponding terminals.
- Turn the screws to the right (clockwise) to secure the wires into the terminals.
- Repeat steps a and b to connect your other adapter.

②

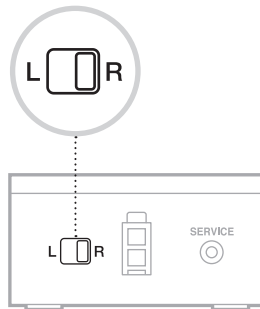

#### Identify switch settings on wireless receivers

- Confirm that the switch on one wireless receiver is set to **R** (right).
- Confirm that the switch on the other wireless receiver is set to **L** (left).

## METHOD 2 (CONTINUED)

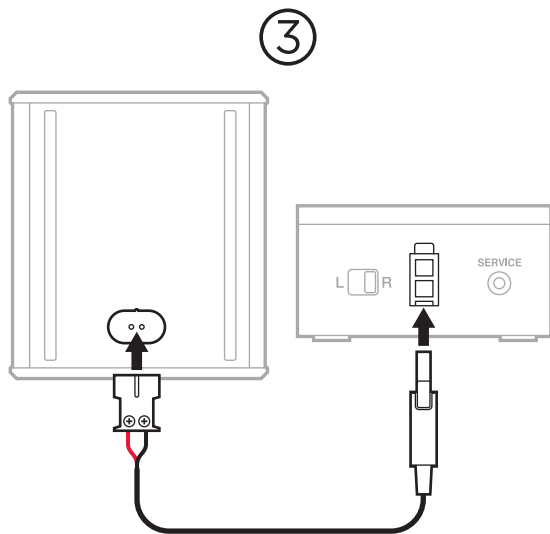

### Connect your rear speakers

- Insert the adapter into the back of the speaker.
- Insert the two-pin connector into the wireless receiver.
- Repeat steps 1 and 2 to set up your other speaker.

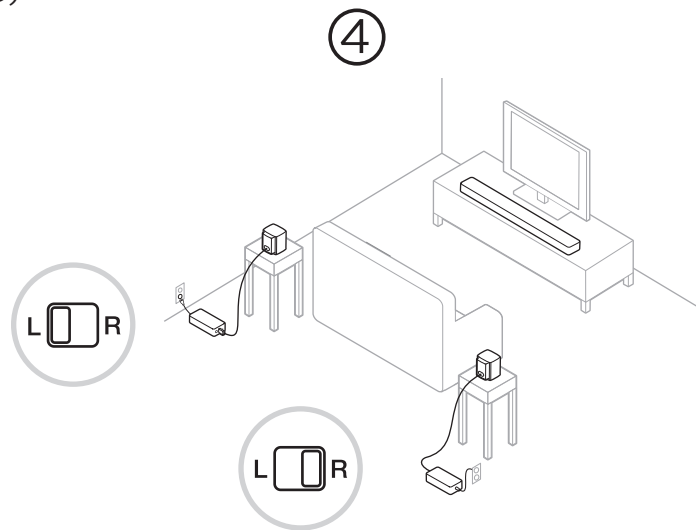

### Place your rear speakers and wireless receivers

- Facing your TV, place the speaker and **R** wireless receiver on the **right** side of your room.
- Facing your TV, place the speaker and **L** wireless receiver on the **left** side of the room.
- Connect to power.



## METHOD 2

(CONTINUED)

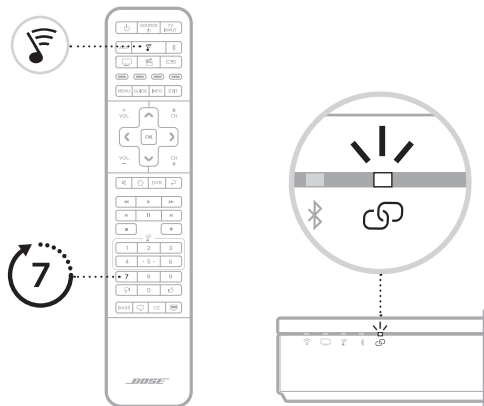
5



### Connect the surround speakers to the soundbar

- On your SoundTouch 300 remote, press .
- Press and hold 7 until  on the soundbar blinks white. Once the surround speaker connects, you hear a tone and  glows white.

**NOTE:** Connecting may take several minutes.

6

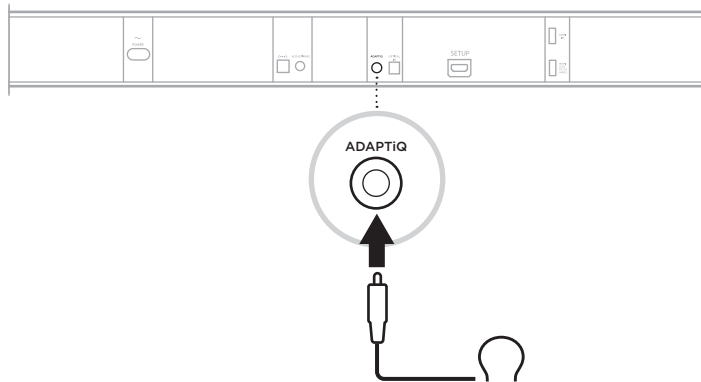



### Set up ADAPTIQ audio calibration

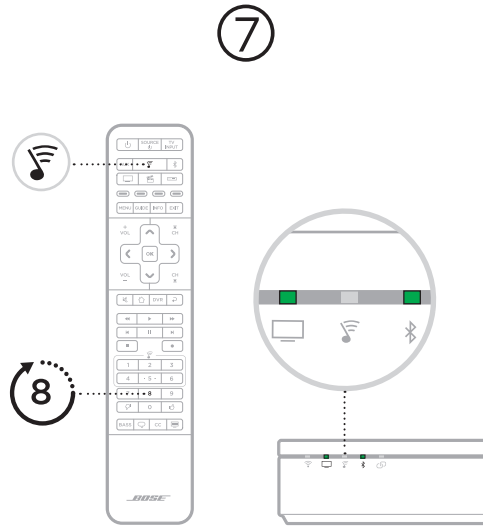

- Connect the ADAPTIQ headset (included with the soundbar) to the soundbar's ADAPTIQ connector.
- Put the headset on your head.

## METHOD 2 (CONTINUED)



### Run ADAPTiQ audio calibration

- On your SoundTouch 300 remote, press .
- Press and hold 8 until  and  on the soundbar glow green.

**NOTE:** To cycle through languages, press  and  on the navigation pad.



[worldwide.Bose.com/Support/WSS](https://worldwide.Bose.com/Support/WSS)



## START HER

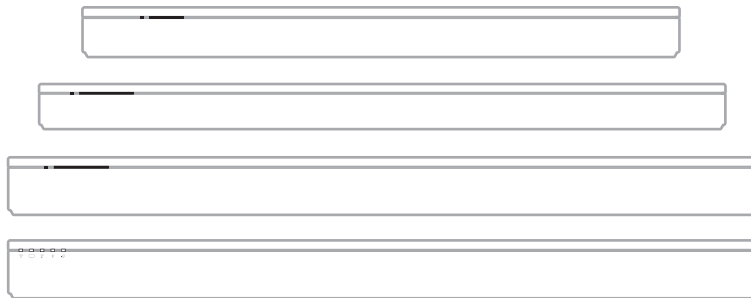

### Vælg opsætningsmetode

Opsætningsmetoden afhænger af, hvilken soundbar du har.

**Bose Soundbar 500, Bose Soundbar 700 eller**

**Bose Smart Soundbar 300:** Se metode 1.

**SoundTouch 300 soundbar:** Se metode 2.



## METODE 1

BOSE SOUNDBAR 500, BOSE SOUNDBAR 700, BOSE SMART SOUNDBAR 300

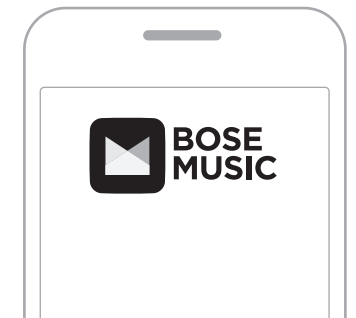

### Opsætning ved hjælp af Bose Music-appen

- I Bose Music-appen skal du vælge din soundbar på skærmbilledet My Products.
- Gå til menuen Settings for at tilføje dine surroundhøjtalere.

---

#### Er det første gang du bruger Bose Music-appen?

Download appen og følg instruktionerne i appen for at konfigurere din soundbar og dine surroundhøjtalere.

## METODE 2

### SOUNDTOUCH 300 SOUNDBAR

1

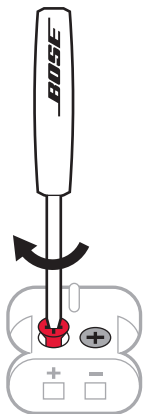

#### Tilslut dine adaptere

- Sæt det farvekodede højttalerkabel i deres tilhørende terminaler.
- Drej skruerne til højre (med uret) for at fastgøre ledningerne i terminalerne.
- Gentag trin a og b for at tilslutte den anden adapter.

2

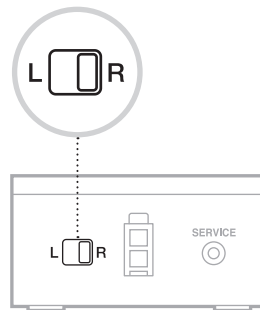

#### Identificer omskifterindstillinger på trådløse modtagere

- Bekræft, at kontakten til den anden trådløse modtager er indstillet til **R** (højre).
- Bekræft, at kontakten til en trådløs modtager er indstillet til **L** (venstre).

## METODE 2 (FORTSAT)

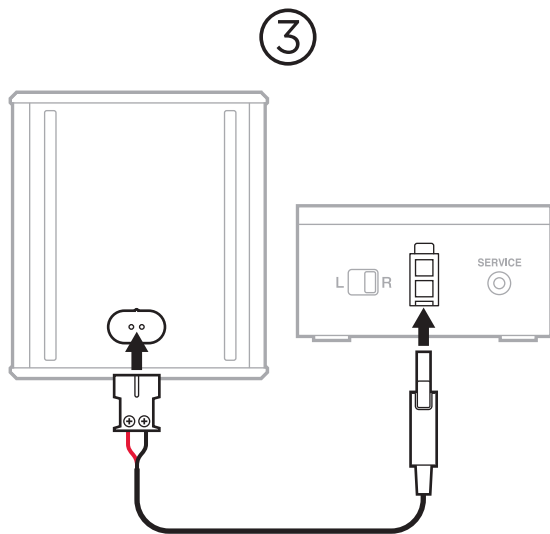

### Tilslut de bagerste højttalere

- Sæt adapteren ind bag på højttaleren.
- Sæt det to-benede stik i den trådløse modtager.
- Gentag trin 1 og 2 for at indstille den anden højttaler.

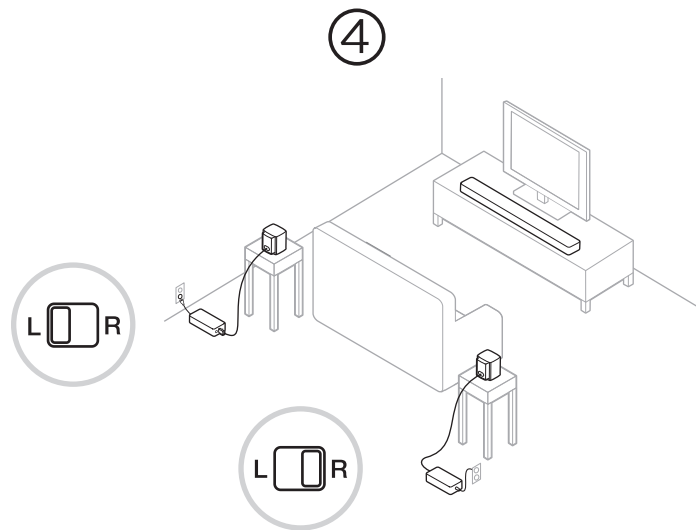

### Placer bagerste højttalere og trådløse modtagere

- Stå over for tv'et, og placer højttaleren og den trådløse modtager **R** i **højre** side af rummet.
- Stå over for tv'et, og placer højttaleren og den trådløse modtager **L** i **venstre** side af rummet.
- Slut til lysnettet.



## METODE 2

(FORTSAT)

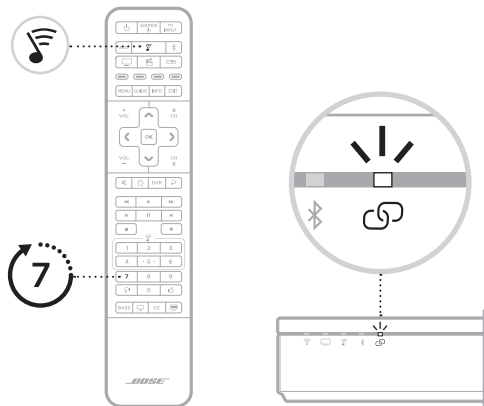
5



### Tilslut surroundhøjtalerne til soundbaren

- På fjernbetjeningen til SoundTouch 300 skal du trykke på .
- Tryk og hold 7, indtil  på soundbaren blinker hvidt.  
Når basmodulet opretter forbindelse, høres der en tone, og  lyser hvidt.

**BEMÆRK:** Det kan tage flere minutter at oprette forbindelse.

6

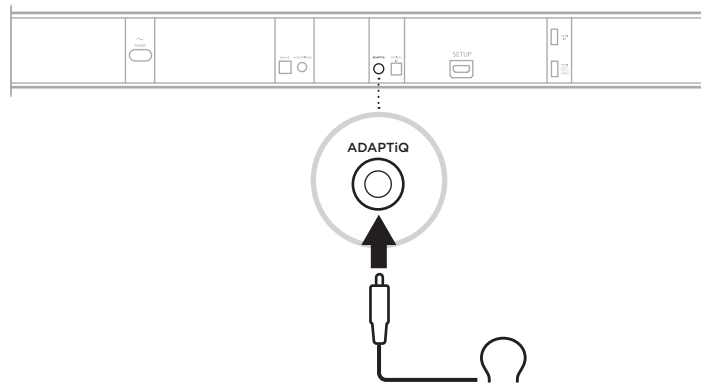

### Konfigurer ADAPTiQ lydkalibrering

- Tilslut ADAPTiQ-headsettet (følger med din soundbar) til stikket **ADAPTiQ** på soundbaren.
- Sæt headsettet på dit hoved.

## METODE 2 (FORTSAT)

7

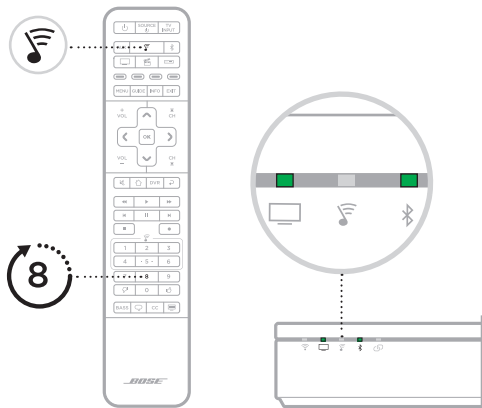



?

[worldwide.Bose.com/Support/WSS](https://worldwide.Bose.com/Support/WSS)



### Kør ADAPTiQ lydkalibrering

- På fjernbetjeningen til SoundTouch 300 skal du trykke på .
- Tryk og hold 8, indtil  og  på soundbaren lyser grønt.

**BEMÆRK:** For at gå igennem de forskellige sprog skal du trykke på  og  i navigationsfeltet.

## HIER STARTEN

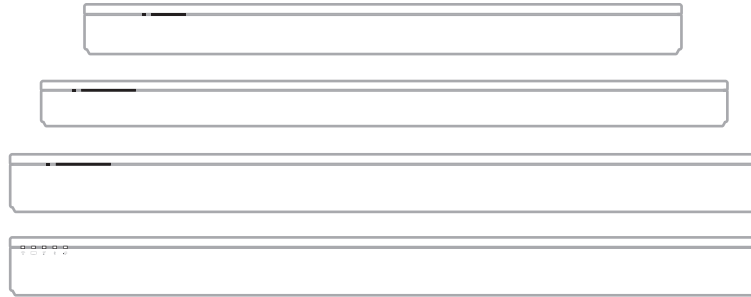

### **Auswählen der Einrichtungsmethode**

Die Einrichtungsmethode hängt davon ab, welche Soundbar Sie haben.

**Bose Soundbar 500, Bose Soundbar 700 oder Bose Smart Soundbar 300:**

Siehe Methode 1.

**SoundTouch 300 Soundbar:** Siehe Methode 2.

## METHODE 1

BOSE SOUNDBAR 500, BOSE SOUNDBAR 700, BOSE SMART SOUNDBAR 300

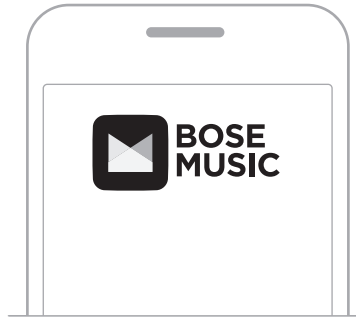

### Einrichten mithilfe der Bose Music-App

- Wählen Sie in der Bose Music-App auf dem Bildschirm „Mein Bose“ Ihre Soundbar aus.
- Gehen Sie zum Menü „Einstellungen“, um Ihre Surround-Lautsprecher hinzuzufügen.

---

### Kennen Sie die Bose Music-App noch nicht?

Laden Sie die App jetzt herunter und folgen Sie den Anweisungen in der App, um Ihre Soundbar und die Surround-Lautsprecher einzurichten.

## METHODE 2

### SOUNDTOUCH 300 SOUNDBAR

①

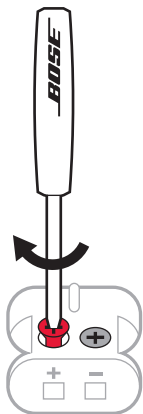

#### Anschließen Ihrer Adapter

- Schließen Sie die farbkodierten Lautsprecherkabeladern an die entsprechenden Klemmen an.
- Drehen Sie die Schrauben nach rechts (im Uhrzeigersinn), um die Adern in den Klemmen zu befestigen.
- Wiederholen Sie die Schritte a und b mit dem anderen Adapter.

②

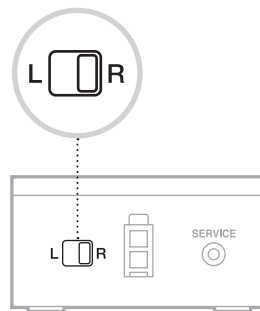

#### Identifizieren der Schaltereinstellungen an drahtlosen Receivern

- Überprüfen Sie, ob der Schalter an einem drahtlosen Receiver auf **R** (rechts) eingestellt ist.
- Überprüfen Sie, ob der Schalter am anderen drahtlosen Receiver auf **L** (links) eingestellt ist.



## METHODE 2 (FORTSETZUNG)

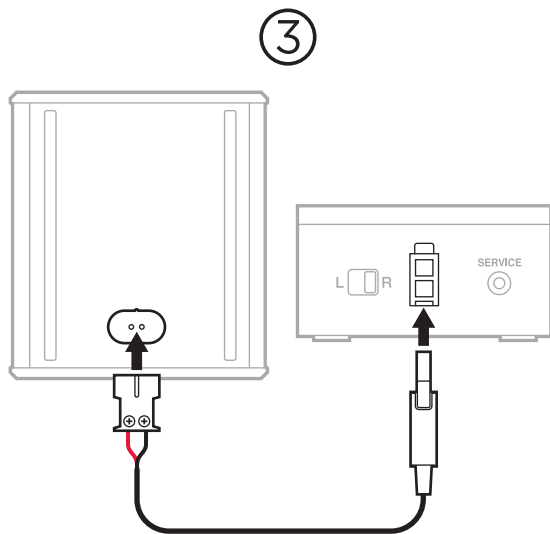

### Anschließen der rückwärtigen Lautsprecher

- Schließen Sie den Adapter an der Rückseite des Lautsprechers an.
- Schließen Sie den zweipoligen Stecker an den drahtlosen Receiver an.
- Wiederholen Sie die Schritte 1 und 2 zum Einrichten des anderen Lautsprechers.

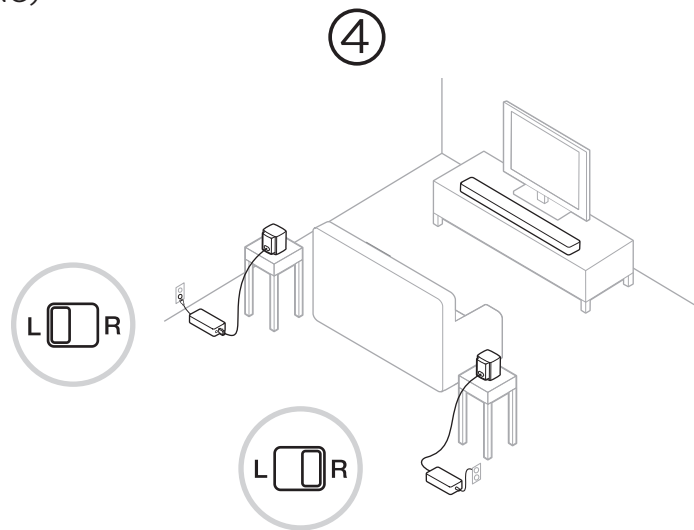

### Aufstellen der rückwärtigen Lautsprecher und drahtlosen Receiver



- Stellen Sie den Lautsprecher und den drahtlosen Receiver **R** auf der **rechten** Seite des Raums auf, wenn Sie in Richtung Fernsehgerät blicken.
- Stellen Sie den Lautsprecher und den drahtlosen Receiver **L** auf der **linken** Seite des Raums auf, wenn Sie in Richtung Fernsehgerät blicken.
- Schließen Sie sie an den Strom an.

## METHODE 2 (FORTSETZUNG)

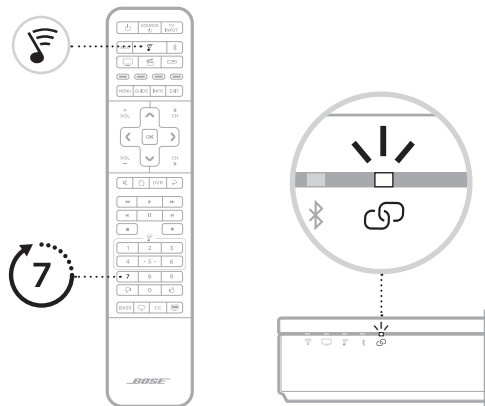
5



### Anschließen der Surround-Lautsprecher an die Soundbar

- Drücken Sie auf der SoundTouch 300-Fernbedienung .
- Halten Sie 7 gedrückt, bis  an der Soundbar weiß blinkt.  
Sobald der Surround-Lautsprecher verbunden ist, hören Sie einen Ton und  leuchtet weiß.

**HINWEIS:** Das Verbinden kann mehrere Minuten dauern.

6

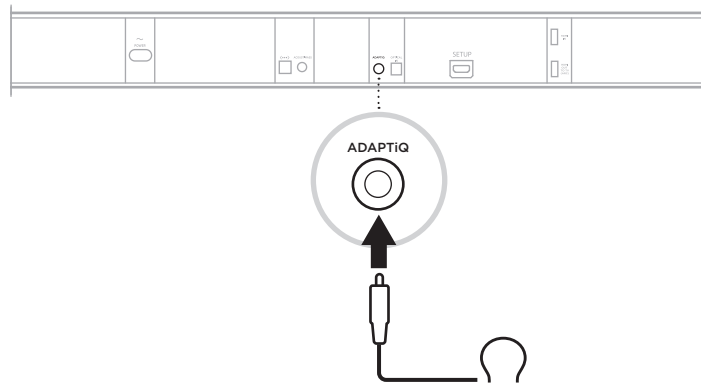

### Einrichten der ADAPTiQ-Audiokalibrierung

- Schließen Sie das ADAPTiQ-Headset (mit der Soundbar mitgeliefert) an den Anschluss ADAPTiQ der Soundbar an.
- Setzen Sie das Headset auf Ihren Kopf.

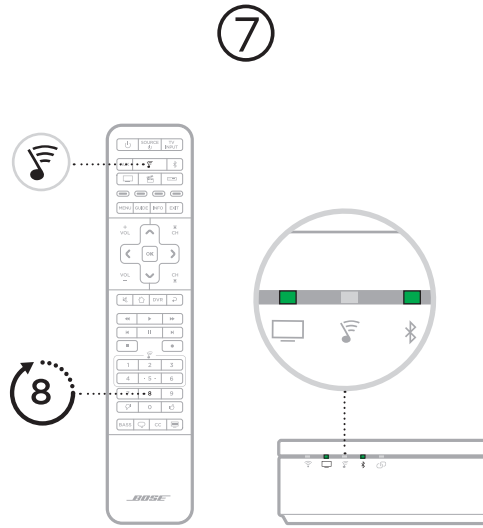

## METHODE 2 (FORTSETZUNG)





[worldwide.Bose.com/Support/WSS](https://worldwide.bose.com/Support/WSS)



### Ausführen der ADAPTiQ-Audiokalibrierung

- Drücken Sie auf der SoundTouch 300-Fernbedienung .
- Halten Sie 8 gedrückt, bis  und  an der Soundbar grün leuchten.

**HINWEIS:** Halten Sie zum Umschalten zwischen den Sprachen  und  auf dem Navigationsfeld gedrückt.

## BEGIN HIER

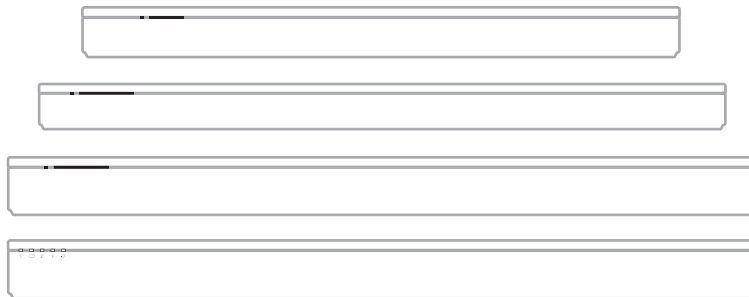

### **Kies uw installatiemethode**

Uw installatiemethode is afhankelijk van welke soundbar u hebt.

**Bose Soundbar 500, Bose Soundbar 700 of**

**Bose Smart Soundbar 300:** Zie methode 1.

**SoundTouch 300 soundbar:** Zie methode 2.

## METHODE 1

BOSE SOUNDBAR 500, BOSE SOUNDBAR 700, BOSE SMART SOUNDBAR 300

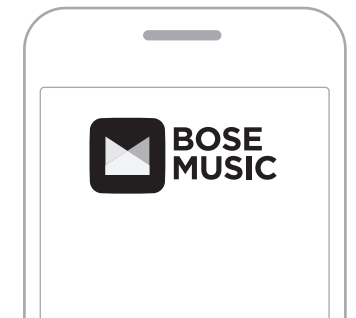

### Installeren met behulp van de Bose Music-app

- a. Selecteer uw soundbar in het scherm Mijn Bose van de Bose Music-app.
- b. Ga naar het menu Instellingen om uw surroundluidsprekers toe te voegen.

---

#### Kent u de Bose Music-app nog niet?

Download de app en volg de instructies in de app om de soundbar en surroundluidsprekers te configureren.

## METHODE 2

### SOUNDTOUCH 300 SOUNDBAR

①

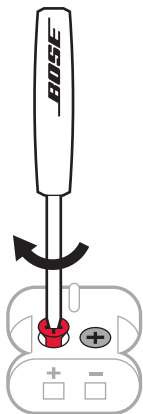

#### De adapters aansluiten

- Steek de kleurgecodeerde draden van de luidsprekerkabel in de overeenkomstige aansluitpunten.
- Draai de schroeven rechtsom (met de klok mee) om de draden vast te zetten in de aansluitklemmen.
- Herhaal stap a en b om de andere adapter aan te sluiten.

②

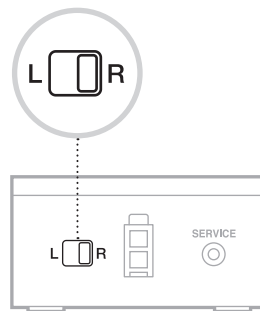

#### De instelling van de schakelaars op de draadloze ontvangers controleren

- Controleer of de schakelaar op één draadloze ontvanger op **R** (rechts) is ingesteld.
- Controleer of de schakelaar op de andere draadloze ontvanger op **L** (links) is ingesteld.

## METHODE 2 (VERVOLG)

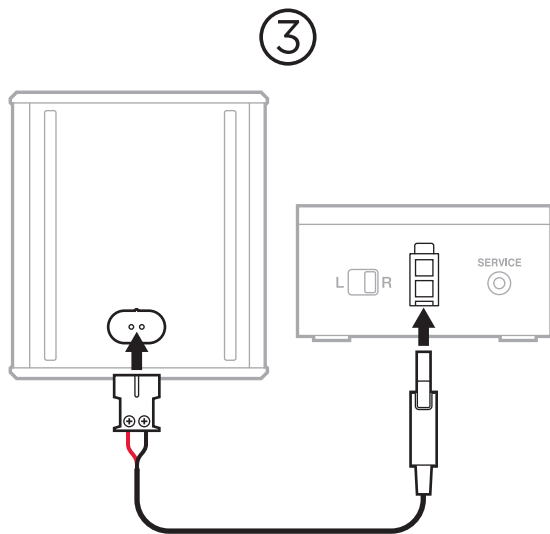

### De achterste luidsprekers aansluiten

- Steek de adapter in de achterkant van de luidspreker.
- Steek de tweepinsstekker in de draadloze ontvanger.
- Herhaal stap 1 en 2 om de andere luidspreker aan te sluiten.

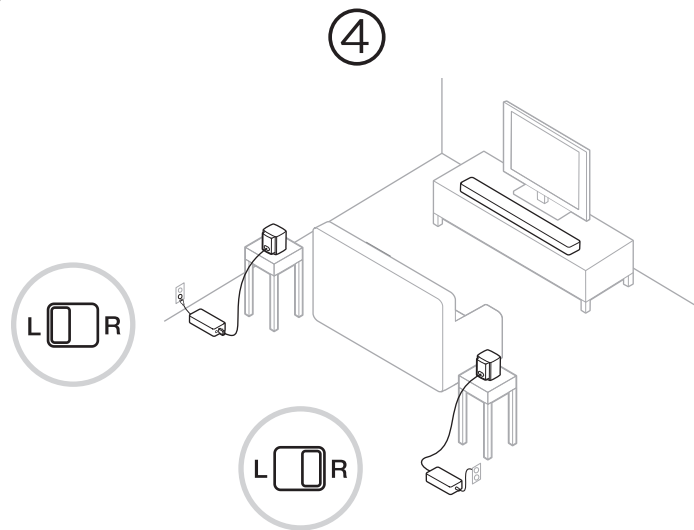

### De achterste luidsprekers en draadloze ontvangers plaatsen



- Ga met uw gezicht naar de tv staan en plaats de luidspreker en de draadloze ontvanger die is ingesteld op **R** aan de **rechterkant** van de kamer.
- Ga met uw gezicht naar de tv staan en zet de luidspreker met de draadloze ontvanger **L** aan de **linkerkant** van de kamer.
- Sluit op het lichtnet aan.

## METHODE 2 (VERVOLG)

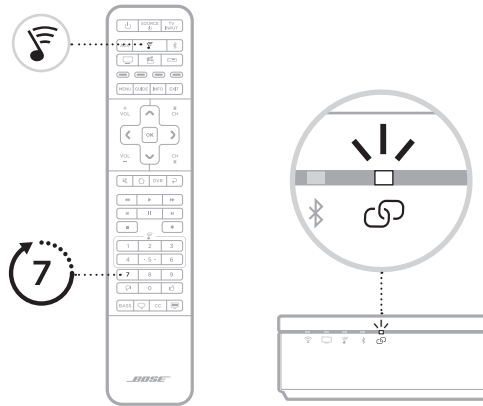
5



### De surroundluidsprekers verbinden met de soundbar

- Druk op de afstandsbediening van de SoundTouch 300 op .
- Houd 7 ingedrukt totdat  op de soundbar wit knippert.  
Wanneer de surroundluidspreker verbinding maakt, hoort u een toon en brandt  wit.

**OPMERKING:** Verbinding maken kan een paar minuten duren.

6

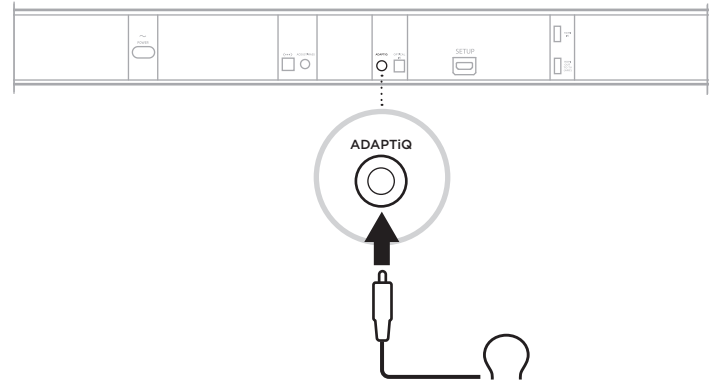

### De ADAPTiQ-audiokalibratie configureren

- Sluit de ADAPTiQ-headset (bijgeleverd bij de soundbar) aan op de aansluiting ADAPTiQ op de soundbar.
- Zet de headset op.



## METHODE 2 (VERVOLG)

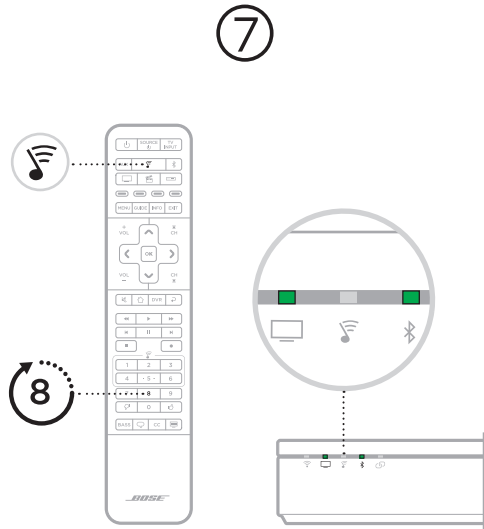



[worldwide.Bose.com/Support/WSS](https://worldwide.Bose.com/Support/WSS)



### De ADAPTiQ-audiokalibratie uitvoeren

- Druk op de afstandsbediening van de SoundTouch 300 op .
- Houd 8 ingedrukt totdat  en  op de soundbar groen branden.

**OPMERKING:** Om door de talen te bladeren, drukt u op  en  op het navigatiepaneel.

## COMENZAR AQUÍ

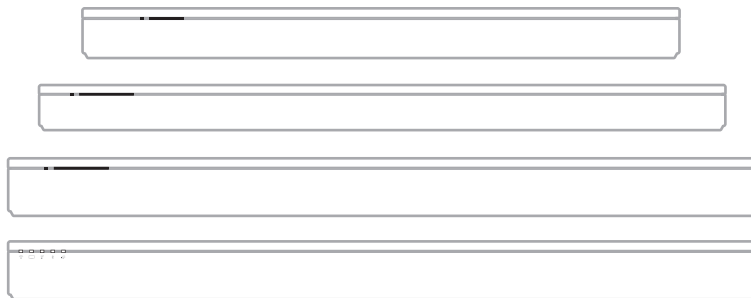

### Elegir el método de configuración

El método de configuración depende de la barra de sonido que tenga.

**Bose Soundbar 500, Bose Soundbar 700 o Bose Smart Soundbar 300:**

Vea el método 1.

**Barra de sonido SoundTouch 300:** Vea el método 2.

# MÉTODO 1

BOSE SOUNDBAR 500, BOSE SOUNDBAR 700, BOSE SMART SOUNDBAR 300



## Configurar usando la aplicación Bose Music

- a. En la aplicación Bose Music, de la pantalla Mis productos, seleccione la barra de sonido.
- b. Vaya al menú de configuración y agregue los altavoces envolventes.

---

### ¿Es la primera vez que usa la aplicación Bose Music?

Descargue la aplicación y siga las instrucciones de la aplicación para configurar la barra de sonido y los altavoces envolventes.

## MÉTODO 2

### BARRA DE SONIDO SOUNDTOUCH 300

1

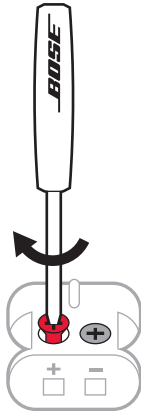

#### Conectar los adaptadores

- Inserte los cables del altavoz con código de color en las terminales correspondientes.
- Gire los tornillos hacia la derecha para asegurar los cables en las terminales.
- Repita los pasos a y b para conectar el otro adaptador.

2

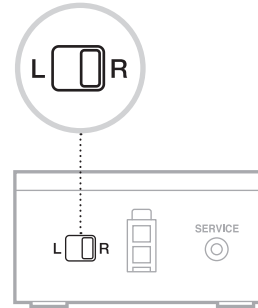

#### Identificar la configuración de los interruptores en los receptores inalámbricos

- Confirme que el interruptor en un receptor inalámbrico se encuentre en la posición **R** (derecha).
- Confirme que el interruptor en el otro receptor inalámbrico se encuentre en la posición **L** (izquierda).

## MÉTODO 2 (CONTINUACIÓN)

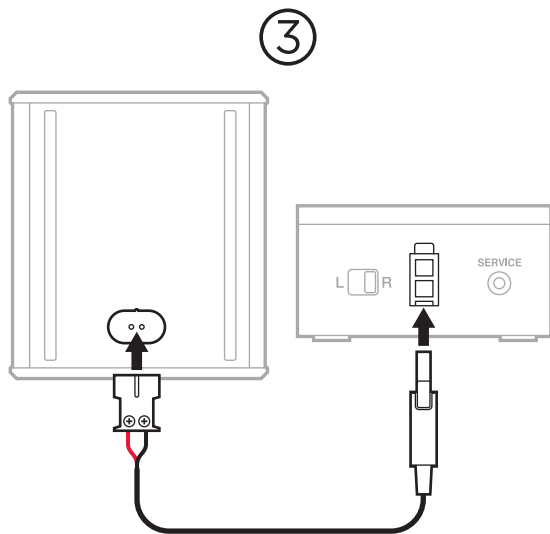

### Conectar los altavoces traseros

- Inserte el adaptador en la parte posterior del altavoz.
- Enchufe el conector de dos pines en el receptor inalámbrico.
- Repita los pasos 1 y 2 para configurar el otro altavoz.

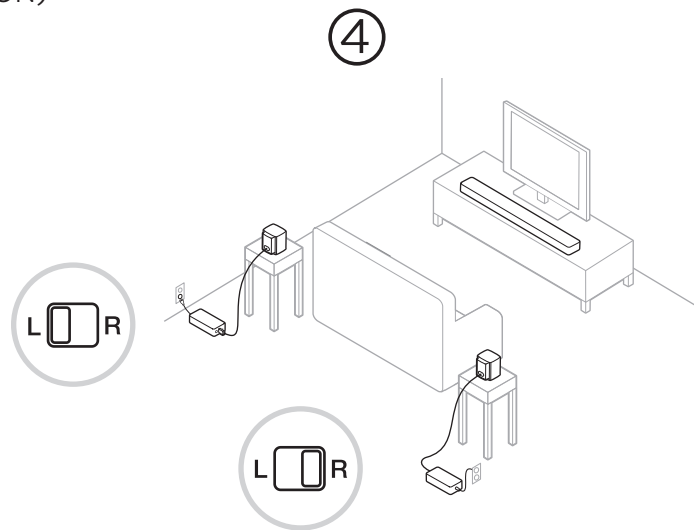



### Ubicar los altavoces posteriores y receptores inalámbricos

- Mirando hacia la TV, coloque el altavoz y el receptor inalámbrico **R** en el lado **derecho** de la habitación.
- Mirando hacia la TV, coloque el altavoz y el receptor inalámbrico **L** en el lado **izquierdo** de la habitación.
- Conecte a la alimentación.

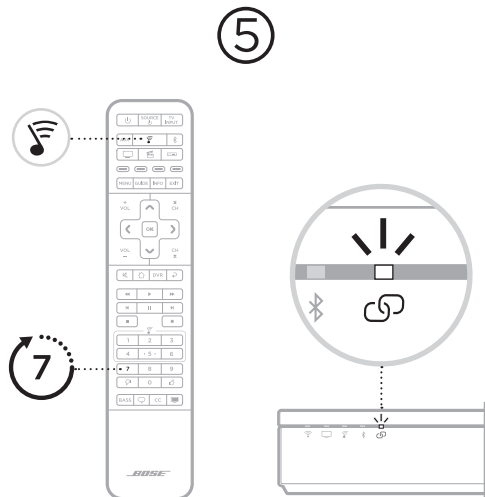
## MÉTODO 2 (CONTINUACIÓN)



### Conectar los altavoces envolventes a la barra de sonido

- En el control remoto de la barra de sonido SoundTouch 300, presione .
- Mantenga presionado 7 hasta que  en la barra de sonido parpadee de color blanco.

Una vez que se conectan los altavoces envolventes, se oye un tono y  se ilumina de color blanco.

**NOTA:** La conexión puede tardar varios minutos.

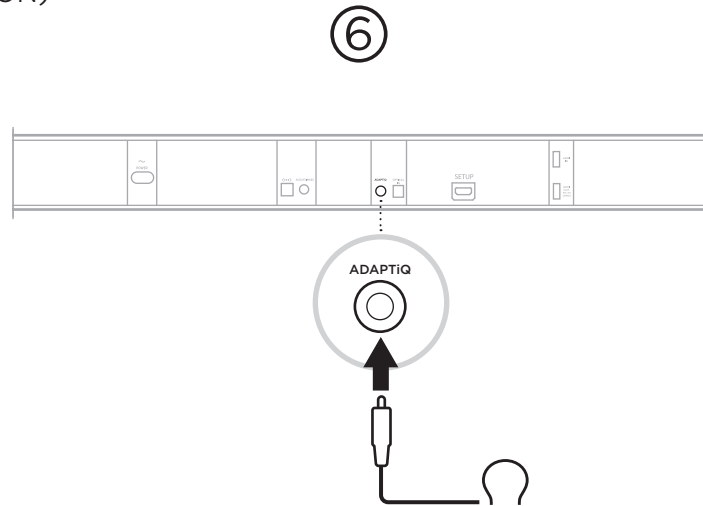

### Configurar la calibración de audio ADAPTiQ

- Conecte los auriculares ADAPTiQ (incluidos con la barra de sonido) al conector ADAPTiQ de la barra de sonido.
- Colóquese los auriculares.

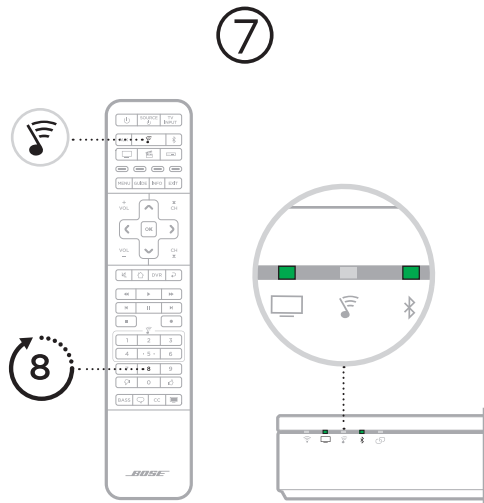

## MÉTODO 2 (CONTINUACIÓN)





[worldwide.Bose.com/Support/WSS](https://worldwide.Bose.com/Support/WSS)



### Ejecutar la calibración de audio ADAPTiQ

- En el control remoto de la barra de sonido SoundTouch 300, presione .
- Mantenga presionado 8 hasta que  y  en la barra de sonido se iluminen de color verde.

**NOTA:** Para cambiar entre los distintos idiomas, presione  y  en el panel de navegación.

# ALOITA TÄSTÄ

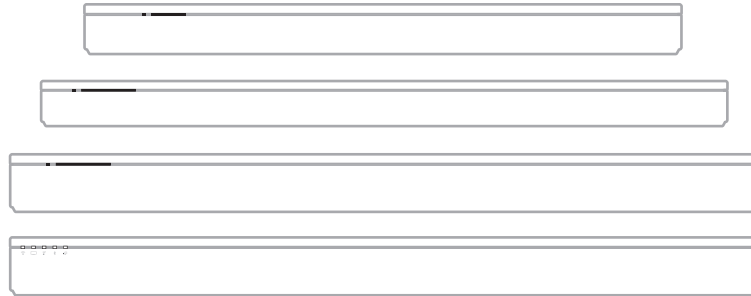

## Valitse määrittystapa.

Määrittystapa vaihtelee käytettävän soundbarin mukaan.

**Bose Soundbar 500, Bose Soundbar 700 tai**

**Bose Smart Soundbar 300:** Katso tapa 1.

**SoundTouch 300 soundbar:** Katso tapa 2.



## TAPA 1

BOSE SOUNDBAR 500, BOSE SOUNDBAR 700, BOSE SMART SOUNDBAR 300



### **Määritä Bose Music -sovelluksella.**

- a. Valitse soundbar Bose Music -sovelluksen Omat tuotteet -näytössä.
- b. Siirry Asetukset-valikkoon ja Lisää tilaäänikaiuttimet.

---

### **Etkö ole ennen käyttänyt Bose Music -sovellusta?**

Lataa sovellus ja määritä soundbar ja kaiuttimet noudattamalla sovelluksen ohjeita.

## TAPA 2

### SOUNDTOUCH 300 SOUNDBAR

①

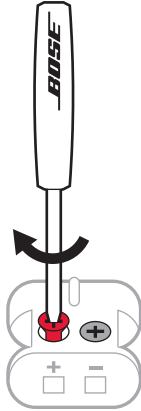

#### Liitä sovitimet.

- Työnnä kaiutinjohdon värikoodatut johtimet oikeisiin liittimiin.
- Kiinnitä johtimet liittimiin kiertämällä ruuveja oikealle (myötäpäivään).
- Liitä toinen sovitin toistamalla vaiheet a ja b.

②

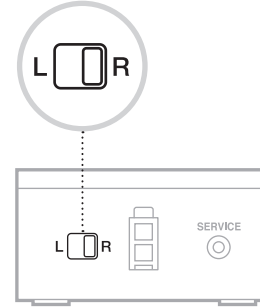

#### Oikeat kytkinasetukset langattomissa vastaanottimissa

- Aseta ensimmäisen langattoman vastaanottimen kytkin asentoon **R** (oikealle).
- Aseta toisen langattoman vastaanottimen kytkin asentoon **L** (vasemmalle).

## TAPA 2 (JATKOA)

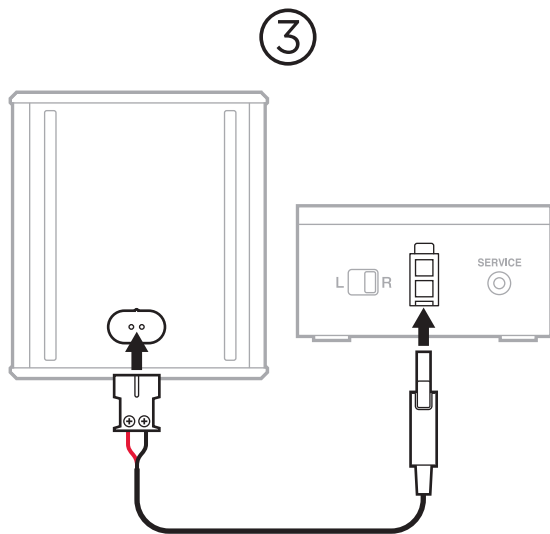

### Liitä takakaiuttimet.

- Työnnä sovitin kaiuttimen takaosaan.
- Työnnä kaksinastainen liitin langattomaan vastaanottimeen.
- Asenna toinen kaiutin toistamalla vaiheet 1 ja 2.

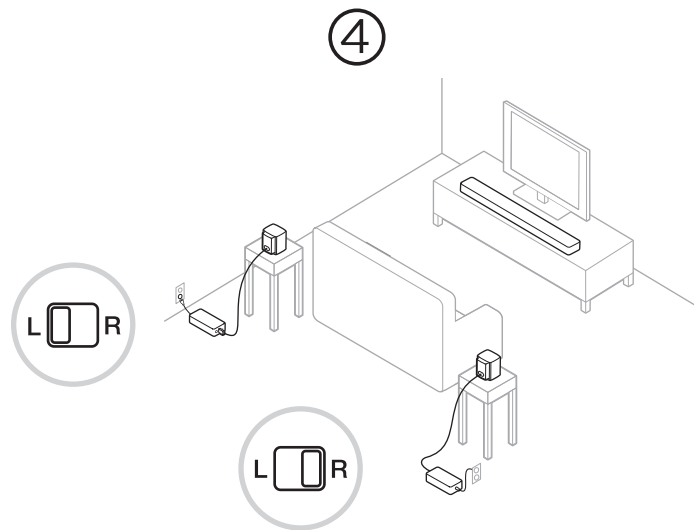

### Sijoita takakaiuttimet ja langattomat vastaanottimet



- Aseta kaiutin ja **R**-merkitty langaton vastaanotin huoneen **oikealle** puolelle siten, että ne ovat televisiota kohti.
- Aseta kaiutin ja **L**-merkitty langaton vastaanotin huoneen **vasemmalle** puolelle siten, että ne ovat televisiota kohti.
- Liitä sähköpistorasiaan.

## TAPA 2 (JATKOA)

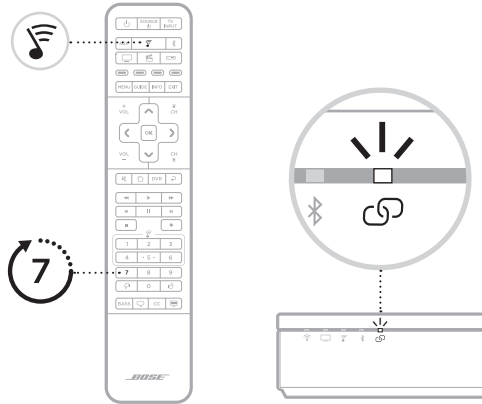
5



### Yhdistä kaiuttimet soundbariin.

- Paina SoundTouch 300 -kaukosäätimen painiketta .
- Pidä 7 painettuna, kunnes soundbarin  alkaa vilkkua valkoisena. Kun tilaäänikaiuttimet muodostavat yhteyden, kuuluu äänimerkki ja  palaa valkoisena.

**HUOMAUTUS:** Yhdistäminen voi kestää useita minuutteja.

6

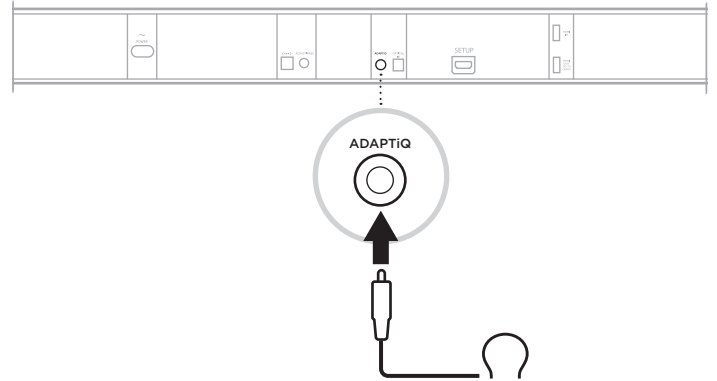

### Valmistele ADAPTiQ-äänenkalibrointijärjestelmä.

- Liitä ADAPTiQ-kuulokkeet (toimitetaan soundbarin mukana) soundbarin ADAPTiQ-liitäntään.
- Aseta kuulokkeet päähäsi.

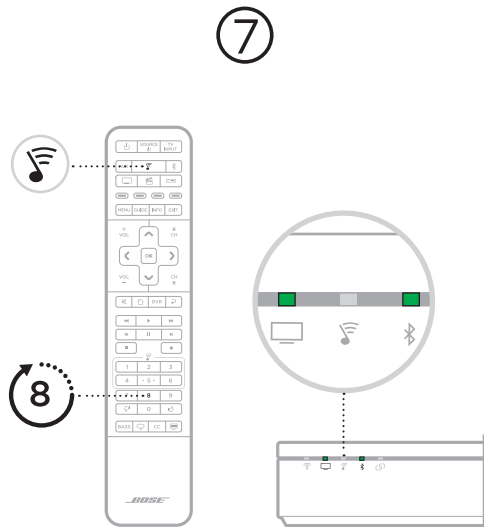

## TAPA 2 (JATKOA)



[worldwide.Bose.com/Support/WSS](https://worldwide.Bose.com/Support/WSS)



### Suorita ADAPTiQ-äänenkalibrointi.

- Paina SoundTouch 300 -kaukosäätimen painiketta .
- Pidä 8 painettuna, kunnes soundbarin  ja  syttyvät vihreinä.

**HUOMAUTUS:** Voit selata kieliä painamalla siirtymistyydyn painikkeita  ja .

## COMMENCER PAR CE DOCUMENT

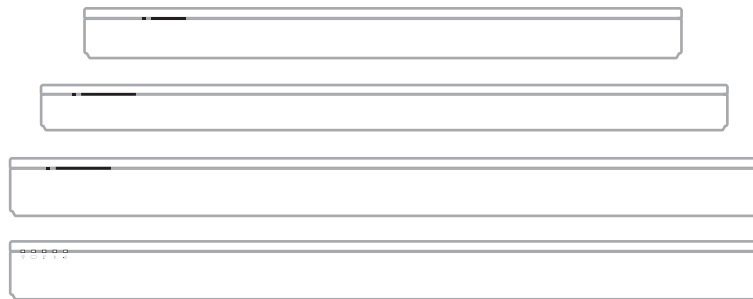

### Sélection de la méthode de configuration

La méthode de configuration dépend de votre barre de son.

**Bose Soundbar 500, Bose Soundbar 700 ou  
Bose Smart Soundbar 300** : voir la Méthode 1.

**Barre de son SoundTouch 300** : voir la Méthode 2.

# MÉTHODE 1

BOSE SOUNDBAR 500, BOSE SOUNDBAR 700, BOSE SMART SOUNDBAR 300

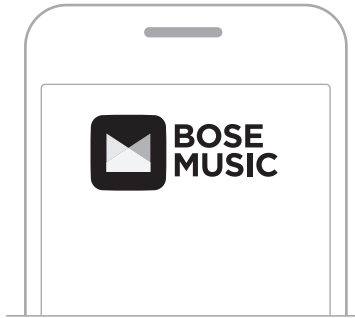

## Configuration à l'aide de l'application Bose Music

- Dans l'application Bose Music, appuyez sur votre barre de son dans l'écran Mes produits.
- Accédez au menu Réglages pour ajouter vos enceintes surround.

---

### Vous découvrez l'application Bose Music ?

Téléchargez l'application et suivez les instructions pour configurer votre barre de son et vos enceintes surround.

## MÉTHODE 2

### BARRE DE SON SOUNDTOUCH 300

①

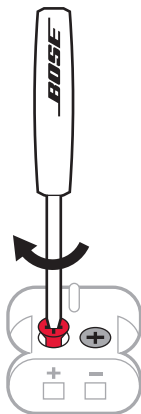

#### Connexion de vos adaptateurs

- Insérez les fils du câble d'enceinte de couleur dans les bornes correspondantes.
- Serrez les vis dans le sens des aiguilles d'une montre (vers la droite) pour fixer les fils aux bornes.
- Répétez les étapes a et b pour connecter l'autre adaptateur.

②

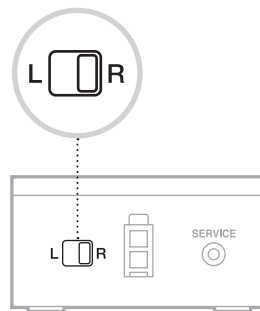

#### Identification des réglages d'interrupteur sur les récepteurs sans fil

- Vérifiez que l'interrupteur sur l'un des récepteurs sans fil est positionné sur **R** (droit).
- Vérifiez que l'interrupteur sur l'autre récepteur sans fil est positionné sur **L** (gauche).



## MÉTHODE 2

(SUITE)

③

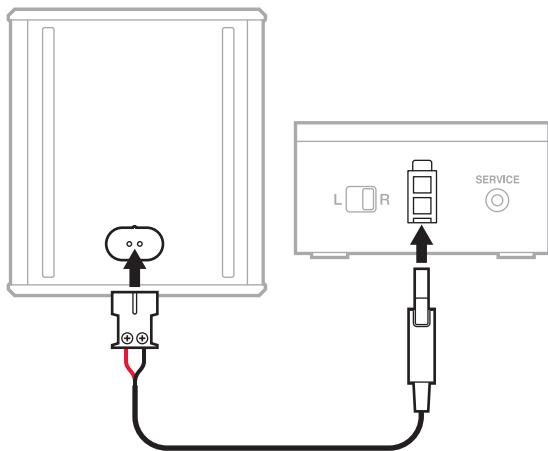

### Connexion des enceintes arrière

- Insérez l'adaptateur à l'arrière de l'enceinte.
- Raccordez le connecteur à deux broches au récepteur sans fil.
- Répétez les étapes 1 et 2 pour connecter l'autre enceinte.

④

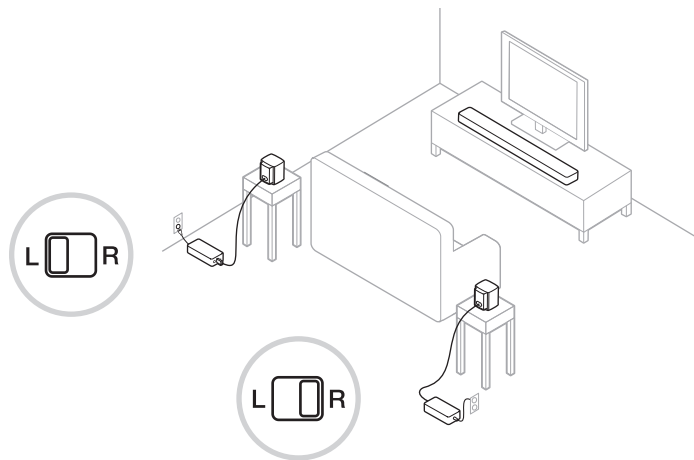

### Installation des enceintes arrière et des récepteurs sans fil



- Installez l'enceinte et le récepteur sans fil **R** à **droite** de la pièce, face à votre téléviseur.
- Installez l'enceinte et le récepteur sans fil **L** à **gauche** de la pièce, face à votre téléviseur.
- Raccordez-le ensuite à la prise secteur.

## MÉTHODE 2

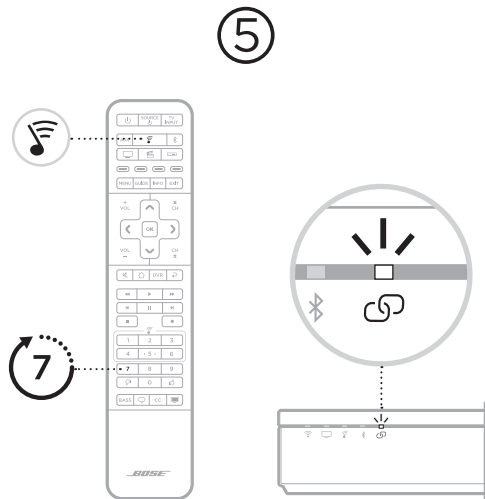
(SUITE)



### Connexion des enceintes surround à la barre de son

- Sur la télécommande de votre barre de son SoundTouch 300, appuyez sur .
- Maintenez enfoncée la touche 7 jusqu'à ce que l'indication  clignote en blanc sur la barre de son.

Une fois les enceintes surround connectées, vous entendez une tonalité et  s'allume en blanc.

**REMARQUE** : la connexion peut prendre plusieurs minutes.

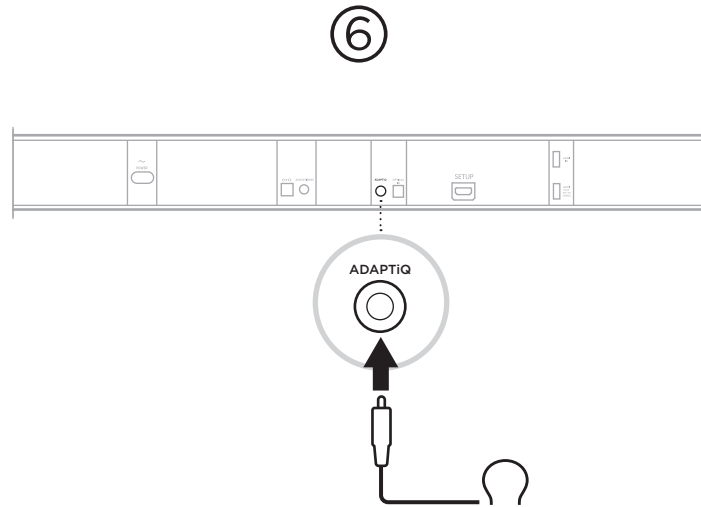

### Configuration de l'étalonnage audio ADAPTiQ

- Raccordez le casque ADAPTiQ (fourni avec la barre de son) au connecteur ADAPTiQ de la barre de son.
- Placez le casque sur votre tête.

## MÉTHODE 2

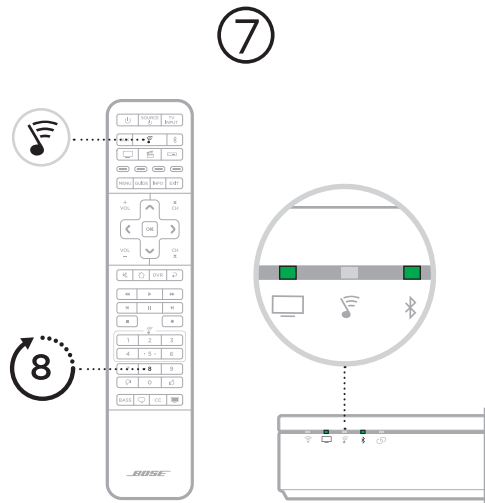

(SUITE)





[worldwide.Bose.com/Support/WSS](https://worldwide.Bose.com/Support/WSS)



### Exécution de l'étalonnage audio ADAPTiQ

- Sur la télécommande de votre barre de son SoundTouch 300, appuyez sur .
- Maintenez enfoncée la touche 8 jusqu'à ce que les indications  et  clignotent en vert sur la barre de son.

**REMARQUE** : pour parcourir les langues, appuyez sur les touches  et  du pavé de navigation.

## INIZIA DA QUI

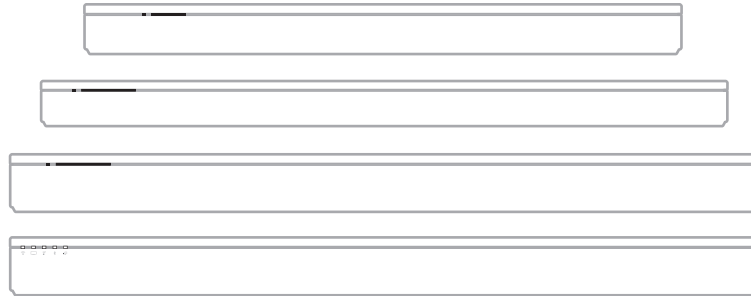

### **Scegliere il metodo di configurazione**

Il metodo di configurazione dipende dal tipo di soundbar in uso.

**Bose Soundbar 500, Bose Soundbar 700 o**

**Bose Smart Soundbar 300:** consultare il Metodo 1.

**Soundbar SoundTouch 300:** consultare il Metodo 2.

## METODO 1

BOSE SOUNDBAR 500, BOSE SOUNDBAR 700, BOSE SMART SOUNDBAR 300

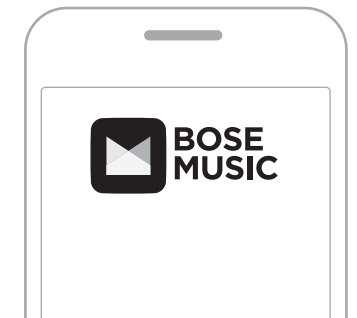

### Impostazione mediante l'app Bose Music

- a. Se si utilizza l'app Bose Music, dalla schermata I miei prodotti selezionare la soundbar in uso.
- b. Andare al menu Impostazioni per aggiungere i diffusori surround.

---

### Cosa fare se non si conosce l'app Bose Music?

Scaricare l'app e seguire le istruzioni fornite per configurare soundbar e diffusori surround.

## METODO 2

### SOUNDBAR SOUNDTOUCH 300

1

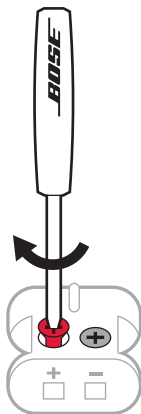

#### Collegare gli adattatori

- Inserire i fili colorati del cavo del diffusore nei terminali di colore corrispondente.
- Girare le viti a destra (in senso orario) per fissare i fili nei terminali.
- Ripetere i passaggi a e b per collegare l'altro adattatore.

2

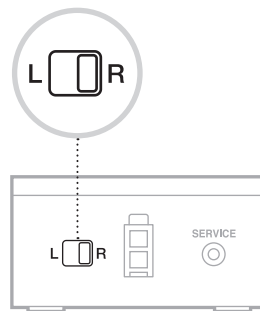

#### Identificare le impostazioni degli interruttori sui ricevitori wireless

- Verificare che l'interruttore su uno dei ricevitori wireless sia in posizione **R** (right, destra).
- Verificare che l'interruttore sull'altro ricevitore wireless sia in posizione **L** (left, sinistra).

## METODO 2 (CONTINUA)

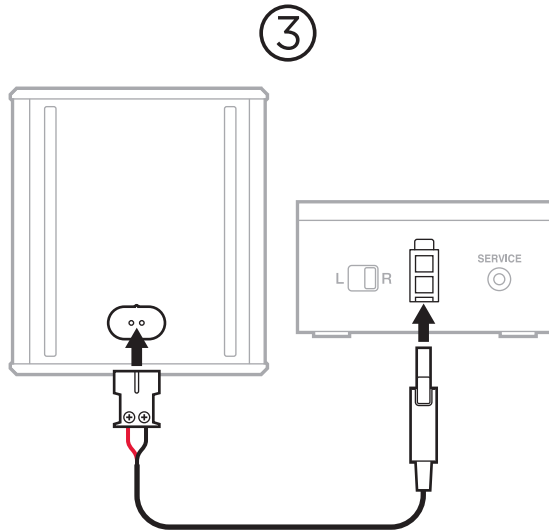

### Collegare i diffusori posteriori

- Inserire l'adattatore nel retro del diffusore.
- Inserire il connettore a due pin nel ricevitore wireless.
- Ripetere i passaggi 1 e 2 per configurare l'altro diffusore.

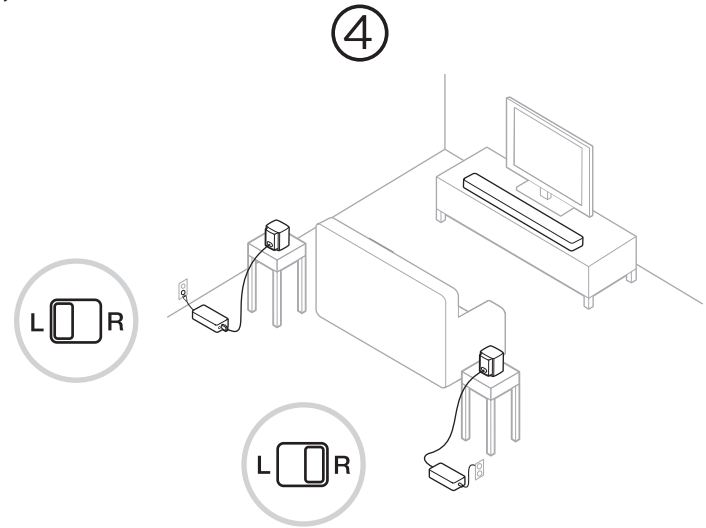



### Collocare i diffusori posteriori e i ricevitori wireless

- Stando di fronte al televisore, collocare il diffusore e il ricevitore wireless **R** nella parte **destra** della stanza.
- Stando di fronte al televisore, collocare il diffusore e il ricevitore wireless **L** nella parte **sinistra** della stanza.
- Collegare all'alimentazione.

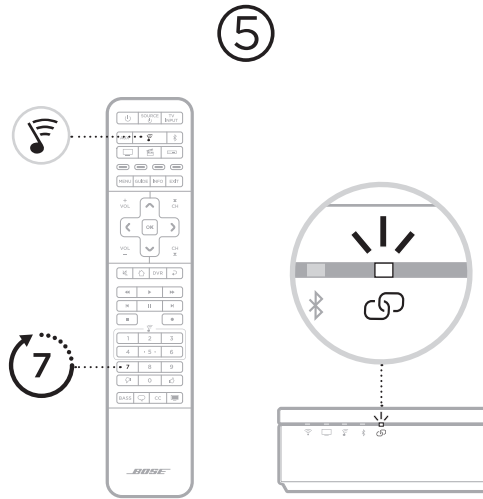
## METODO 2 (CONTINUA)



### Collegare i diffusori surround alla soundbar

- Sul telecomando SoundTouch 300, premere .
- Premere e tenere premuto 7 fino a quando il simbolo  sulla soundbar non lampeggia in bianco.

Non appena il diffusore surround si collega, si sente un segnale acustico e il simbolo  si illumina in bianco.

**NOTA:** la connessione potrebbe richiedere diversi minuti.

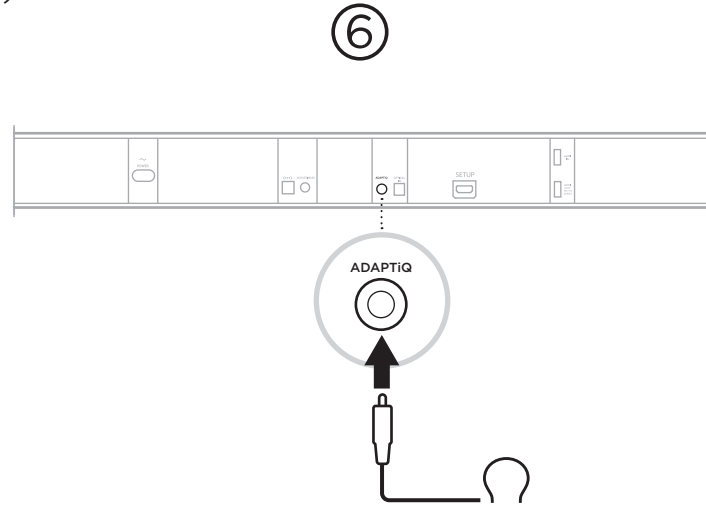

### Impostare la calibrazione audio ADAPTiQ

- Collegare le cuffie ADAPTiQ (accluse alla soundbar) al connettore ADAPTiQ della soundbar.
- Indossare le cuffie.



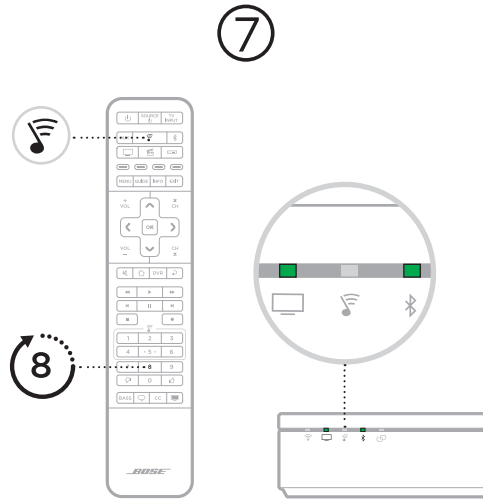

## METODO 2 (CONTINUA)





[worldwide.Bose.com/Support/WSS](https://worldwide.Bose.com/Support/WSS)



### Eeguire la calibrazione audio ADAPTiQ

- Sul telecomando SoundTouch 300, premere .
- Premere e tenere premuto 8 finché i simboli  e  sulla soundbar non lampeggiano in verde.

**NOTA:** per scorrere le lingue disponibili, premere  e  sul pad di navigazione.

# ELSŐ LÉPÉSEK

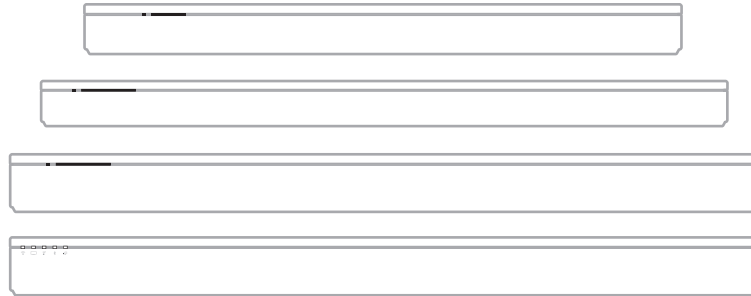

## Válassza ki a beállítási módszert

A beállítási módszer attól függően változik, hogy melyik hangszugárzóval rendelkezik.

**Bose Soundbar 500, Bose Soundbar 700 vagy Bose Smart Soundbar 300:** Lásd: 1. módszer

**SoundTouch 300 hangszugárzó:** Lásd: 2. módszer

# 1. MÓDSZER

BOSE SOUNDBAR 500, BOSE SOUNDBAR 700, BOSE SMART SOUNDBAR 300



## Beállítás a Bose zenei alkalmazás segítségével

- A Bose Music alkalmazás Termékeim képernyőjén válassza ki a hangsugárzót.
- A térhangzású hangszórók hozzáadásához lépjen a Beállítások menübe.

---

### Először használja a Bose zenei alkalmazást?

Töltse le az alkalmazást, és a hangsugárzó és a térhangzású hangszórók beállításához kövesse az alkalmazás utasításait.

## 2. MÓDSZER

### SOUNDTOUCH 300 HANGSUGÁRZÓ

1

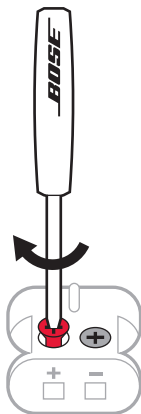

#### Csatlakoztassa az adaptereket

- A színekkel jelölt hangszórókábeleket dugja be a megfelelő csatlakozóvégekbe.
- A csavarokat jobbra (az óramutató járásával megegyező irányba) forgatva erősítse a kábeleket a csatlakozóvégekbe.
- A többi adapter csatlakoztatásához ismételje meg a lépéseket.

2

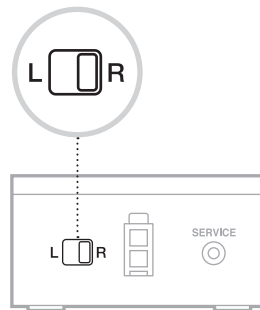

#### Ellenőrizze a vezeték nélküli vevőegység kapcsolóbeállításait

- Győződjön meg róla, hogy az egyik vezeték nélküli vevőegység kapcsolója **R** (jobb) állásban van.
- Győződjön meg róla, hogy a másik vezeték nélküli vevőegység kapcsolója **L** (bal) állásban van.

## 2. MÓDSZER (FOLYTATÁS)

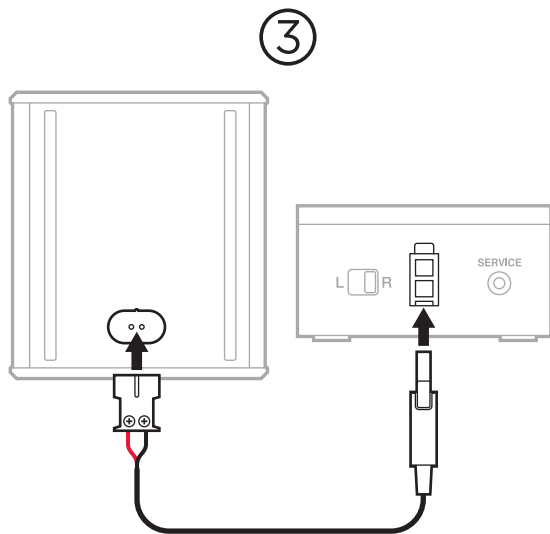

### Csatlakoztassa a hátsó hangszórókat

- Dugja az adaptert a hangszóró hátuljába.
- Dugja a kéttűs csatlakozót a vezeték nélküli vevőegységbe.
- A többi hangszóró beállításához ismételje meg az 1. és 2. lépést.

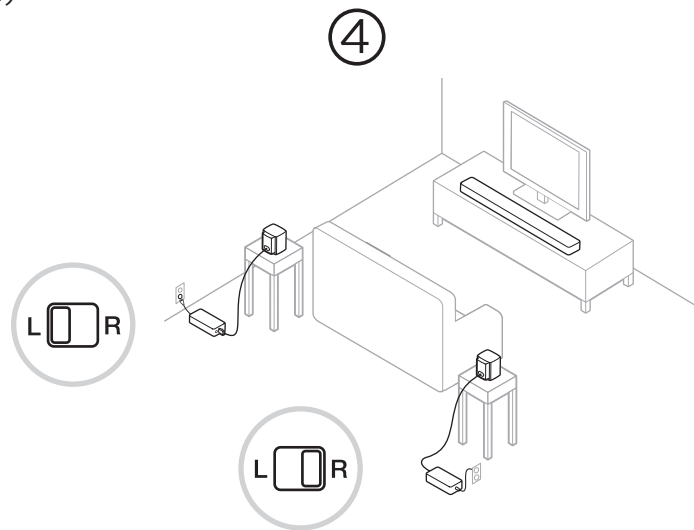

### Helyezze el a hátsó hangszórókat és a vezeték nélküli vevőket

- Álljon szemben a tévével, és helyezze a hangszórót és az **R** jelzésű vezeték nélküli vevőegységet a szoba **jobb** oldali részébe.
- Álljon szemben a tévével, és helyezze a hangszórót és az **L** jelzésű vezeték nélküli vevőegységet a szoba **bal** oldali részébe.
- Csatlakoztassa az áramforráshoz.

## 2. MÓDSZER (FOLYTATÁS)

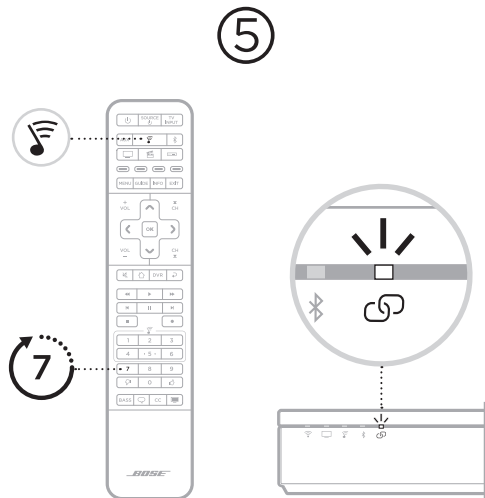

### Csatlakoztassa a térhangzású hangszórókat a hangszugárzóhoz

- A SoundTouch 300 távvezérlőjén nyomja meg az gombot.
- Nyomja le és tartsa lenyomva a 7 gombot, amíg a hangszugárzó jelzőfénye fehéren nem villog.

A térhangzású hangszórók kapcsolódását egy hangjelzés jelzi, és az fény fehéren világít.

**MEGJEGYZÉS:** A csatlakoztatás néhány percre tart.

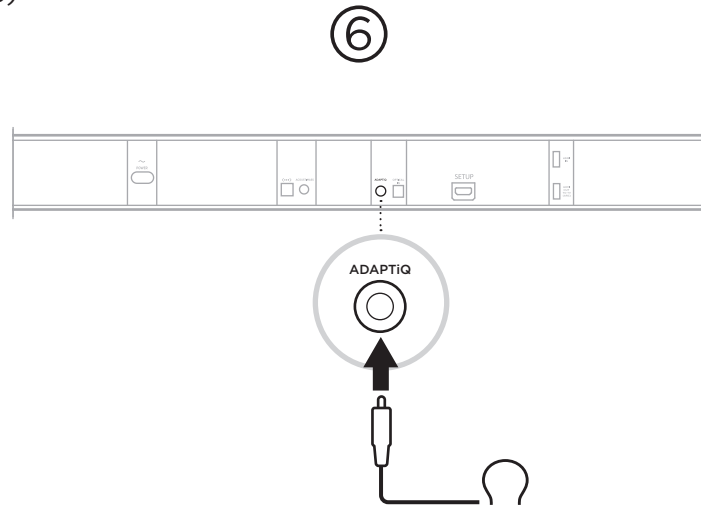

### Állítsa be az ADAPTiQ hangkalibrációt

- Csatlakoztassa az ADAPTiQ fejhallgatót (a hangszugárzóhoz mellékelve) a hangszugárzó ADAPTiQ csatlakozójához.
- Tegye a fejhallgatót a fejére.

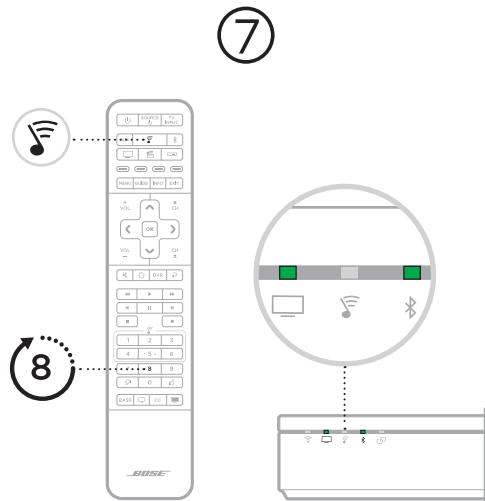

## 2. MÓDSZER (FOLYTATÁS)





[worldwide.Bose.com/Support/WSS](https://worldwide.Bose.com/Support/WSS)



### Futtassa le az ADAPTiQ hangkalibrációt

- A SoundTouch 300 távvezérlőjén nyomja meg az  gombot.
- Nyomja le, és tartsa lenyomva a 8 gombot, amíg a hangszugárzó  és  fénye zölden nem világít.

**MEGJEGYZÉS:** A nyelvek közötti váltáshoz nyomogassa a navigációs panel  és  gombját.

## START HER

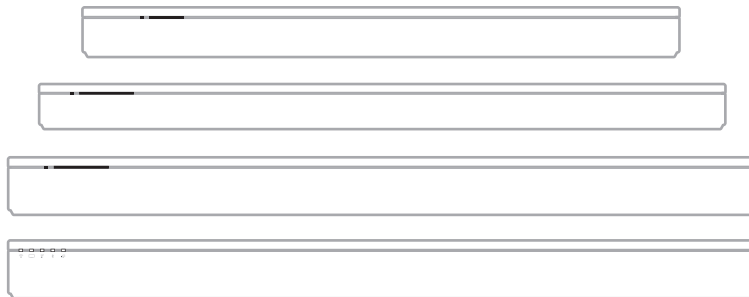

### **Velge metode for konfigurering**

Konfigurasjonsmetoden avhenger av lydplanken.

**Bose Soundbar 500, Bose Soundbar 700 eller**

**Bose Smart Soundbar 300:** Se metode 1.

**SoundTouch 300-lydplanke:** Se metode 2.



## METODE 1

BOSE SOUNDBAR 500, BOSE SOUNDBAR 700, BOSE SMART SOUNDBAR 300



### Konfigurere med Bose Music-appen

- I Bose Music-appen går du til skjermbildet My Products (Mine produkter) og velger lydplanken.
- Gå til innstillingsmenyen for å legge til surroundhøytalerne.

---

### Har du ikke brukt Bose Music-appen tidligere?

Last ned appen og følg instruksjonene i den for å konfigurere lydplanken og surroundhøytalerne.

## METODE 2

### SOUNDTOUCH 300-LYDPLANKE

1

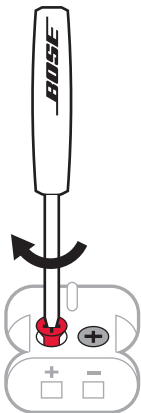

#### Koble til adapterne

- Sett de fargekodede høyttalerkablene inn i de tilsvarende terminalene.
- Vri skruene mot høyre (med urviseren) for å feste kablene til terminalene.
- Gjenta trinn a og b for å koble til den andre adapteren.

2

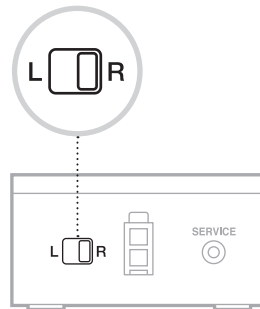

#### Finn bryterinnstillingene på de trådløse mottakerne

- Bekreft at bryteren på den ene trådløse mottakeren er satt til **R** (høyre).
- Bekreft at bryteren på den andre trådløse mottakeren er satt til **L** (venstre).

## METODE 2

(FORTS.)

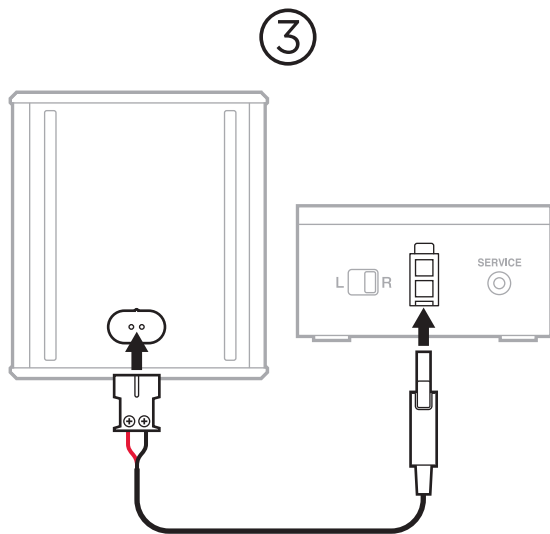

### Koble til høyttalerne

- Sett adapteren inn på baksiden av høyttaleren.
- Sett topinnerskontakten inn i den trådløse mottakeren.
- Gjenta trinn 1 og 2 for å koble til den andre høyttaleren.

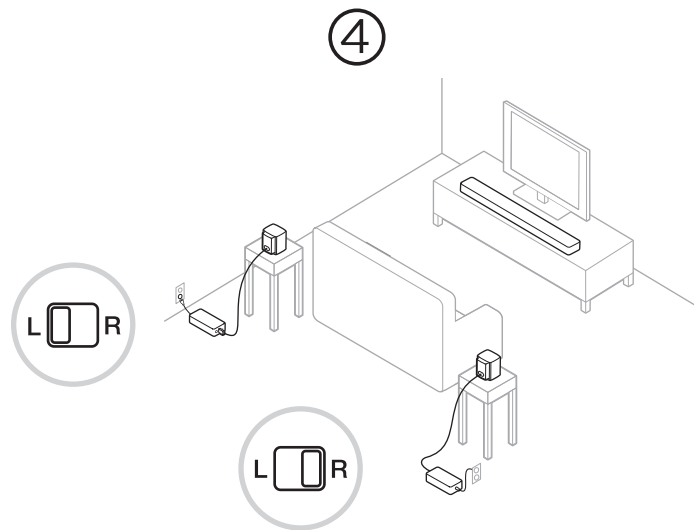

### Plasser bakhøyttalerne og de trådløse mottakerne



- Plasser høyttaleren rettet mot TV-en og den trådløse **R**-mottakeren til **høyre** i rommet.
- Plasser høyttaleren rettet mot TV-en og den trådløse **L**-mottakeren til **venstre** i rommet.
- Koble til strøm.

## METODE 2 (FORTS.)

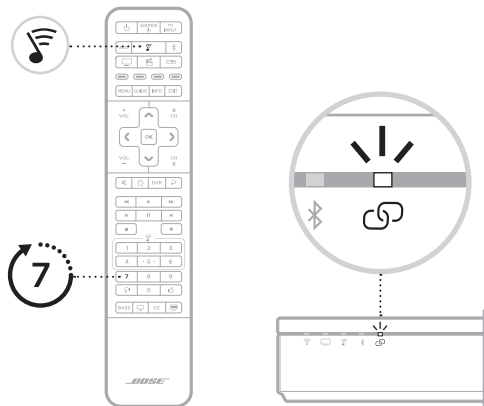
5



### Koble surroundhøytalerne til lydplanken

- Trykk på  på fjernkontrollen for SoundTouch 300.
- Trykk og hold inne 7 til  på lydplanken blinker hvitt.  
Når surroundhøytalerne kobler til, spilles det av en tone og  lyser hvitt.

**MERKNAD:** Det kan ta flere minutter å opprette tilkoblingen.

6

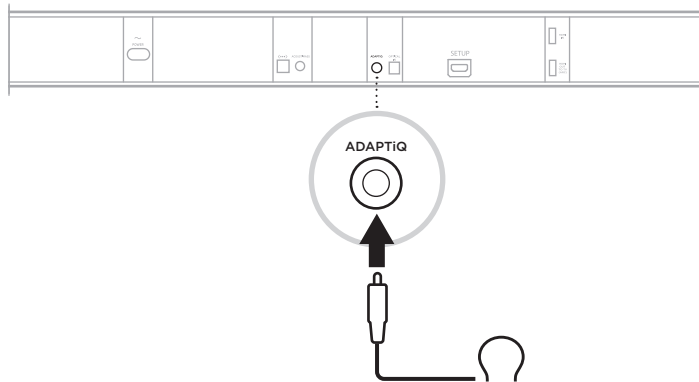

### Konfigurere ADAPTiQ-lydkalibreringen

- Koble ADAPTiQ-hodetelefonene (følger med lydplanken) til ADAPTiQ-kontakten på lydplanken.
- Ta på deg hodetelefonene.



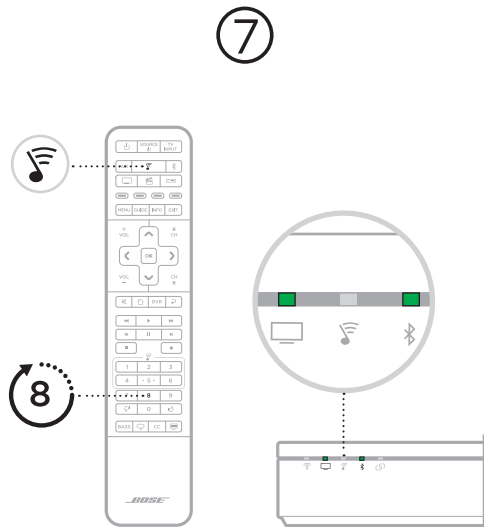

## METODE 2 (FORTS.)





[worldwide.Bose.com/Support/WSS](https://worldwide.Bose.com/Support/WSS)



### Kjøre ADAPTiQ-lydkalibreringen

- Trykk på  på fjernkontrollen for SoundTouch 300.
- Trykk og hold inne  til  og  på lydplanken lyser grønt.

**MERKNAD:** Du går gjennom språkene ved å trykke på  og  på navigasjonsplaten.

# ROZPOCZNIJ

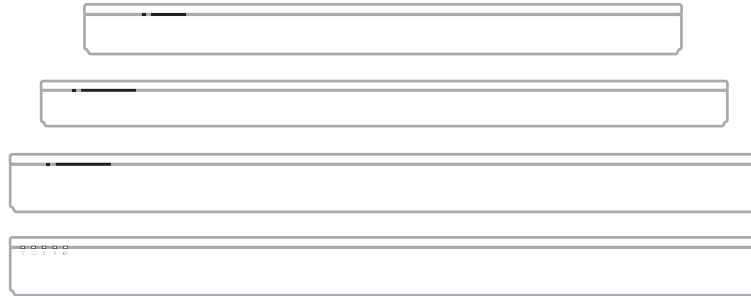

## Wybór metody konfiguracji

Metoda konfiguracji zależy od rodzaju głośnika soundbar.

**Bose Soundbar 500, Bose Soundbar 700 lub  
Bose Smart Soundbar 300:** zobacz metoda nr 1.

**SoundTouch 300:** zobacz metoda nr 2.

## METODA NR 1

BOSE SOUNDBAR 500, BOSE SOUNDBAR 700, BOSE SMART SOUNDBAR 300

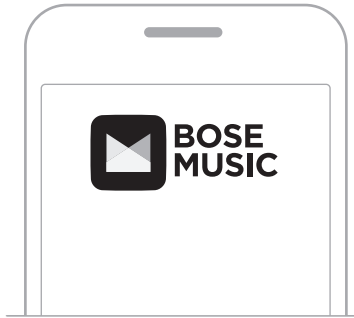

### Konfiguracja przy użyciu aplikacji Bose Music

- a. W aplikacji Bose Music na ekranie Moje Bose wybierz swój głośnik soundbar.
- b. Aby dodać głośniki surround, skorzystaj z menu Ustawienia.

---

### Nie masz jeszcze aplikacji Bose Music?

Aby skonfigurować głośnik soundbar i głośniki surround, pobierz aplikację i postępuj dalej zgodnie z wyświetlanymi w niej instrukcjami.

## METODA NR 2

### SOUNDTOUCH 300

1

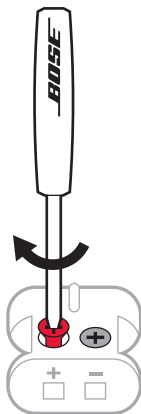

#### Podłączanie adapterów

- Włóż oznaczone kolorami przewody kabla głośnikowego do odpowiednich zacisków.
- Aby zamocować przewody w zaciskach, obróć śruby w prawo (zgodnie z kierunkiem ruchu wskazówek zegara).
- Powtórz kroki a i b, aby podłączyć drugi adapter.

2

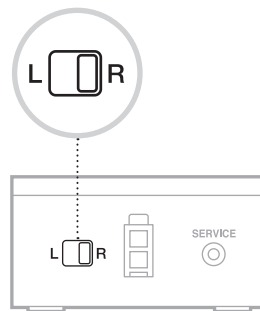

#### Sprawdzanie ustawienia przełączników odbiorników bezprzewodowych

- Sprawdź, czy przełącznik na jednym z odbiorników bezprzewodowych jest ustawiony w położeniu prawym (**R**).
- Sprawdź, czy przełącznik na drugim z odbiorników bezprzewodowych jest ustawiony w położeniu lewym (**L**).



## METODA NR 2 (KONTYNUACJA)

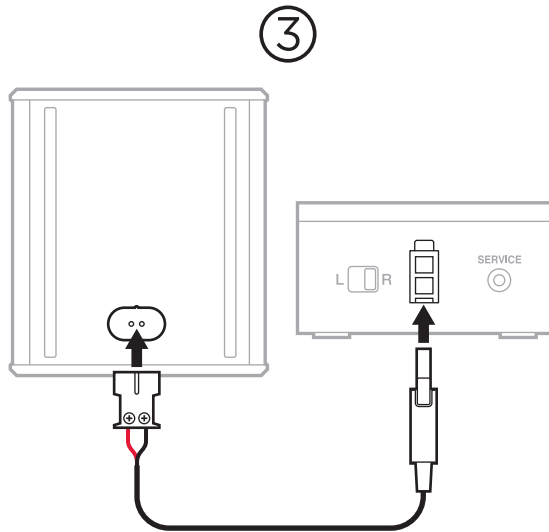

### Podłączanie głośników tylnych

- Podłącz adapter do złącza na tylnym panelu głośnika.
- Podłącz wtyczkę z dwoma bolcami do złącza w odbiorniku bezprzewodowym.
- Powtórz kroki 1 i 2, aby podłączyć drugi głośnik.

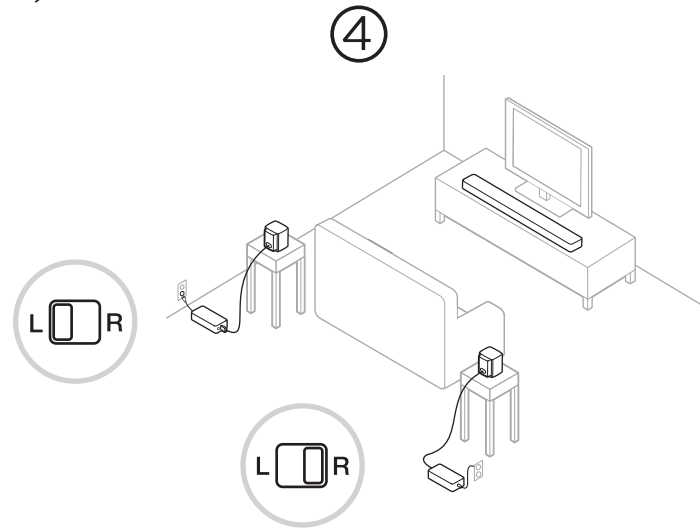

### Wybór lokalizacji głośników tylnych i odbiorników bezprzewodowych

- Umieść głośnik i odbiornik bezprzewodowy **R** z **prawej** strony pomieszczenia, tak aby głośnik był skierowany przodem w kierunku telewizora.
- Umieść głośnik i odbiornik bezprzewodowy **L** z **lewej** strony pomieszczenia, tak aby głośnik był skierowany przodem w kierunku telewizora.
- Podłącz zasilanie.

## METODA NR 2 (KONTYNUACJA)

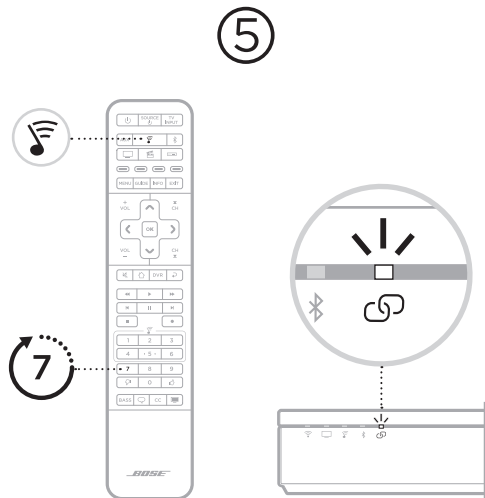

### Podłączanie głośników surround do głośnika soundbar

- Naciśnij przycisk pilota zdalnego sterowania głośnika SoundTouch 300.
- Naciśnij przycisk 7 i przytrzymaj go do chwili, gdy biały wskaźnik na głośniku soundbar zacznie migać.

Po podłączeniu głośnika surround zostanie odtworzony sygnał dźwiękowy, a biały wskaźnik zostanie włączony.

**UWAGA:** Ustanawianie połączenia może trwać kilka minut.

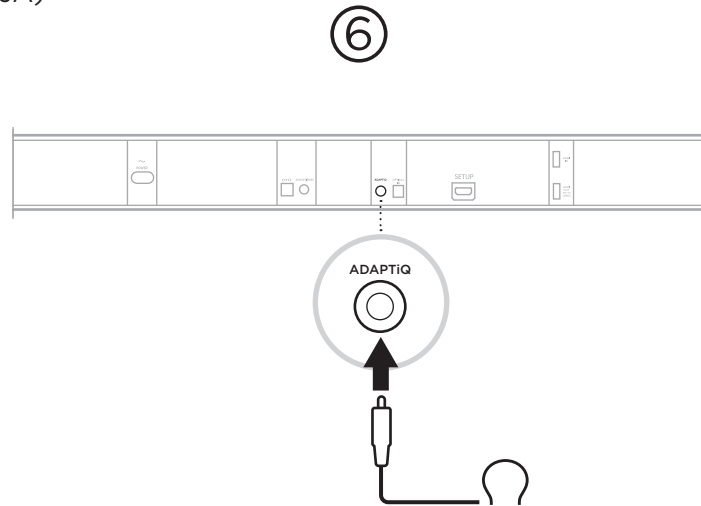

### Konfigurowanie kalibracji dźwięku ADAPTiQ

- Podłącz zestaw słuchawkowy ADAPTiQ (dostarczony w pakiecie z głośnikiem soundbar) do złącza ADAPTiQ głośnika soundbar.
- Załóż zestaw słuchawkowy.

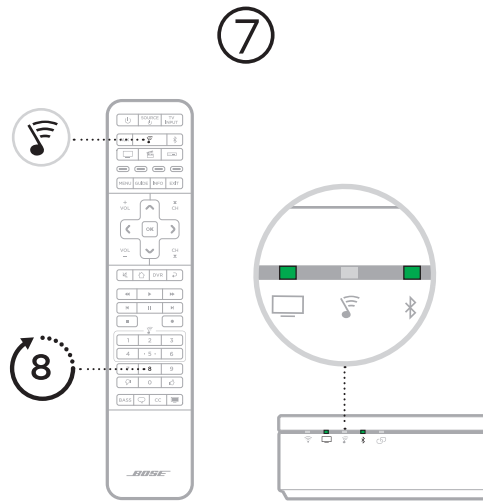

## METODA NR 2 (KONTYNUACJA)





[worldwide.Bose.com/Support/WSS](https://worldwide.Bose.com/Support/WSS)



### Uruchamianie kalibracji dźwięku ADAPTiQ

- Naciśnij przycisk  pilota zdalnego sterowania głośnika SoundTouch 300.
- Naciśnij przycisk 8 i przytrzymaj go do chwili, gdy zielone wskaźniki  i  na głośniku soundbar zostaną włączone.

**UWAGA:** Aby zmienić wersję językową, należy użyć przycisków nawigacyjnych  i .

## COMEÇAR AQUI

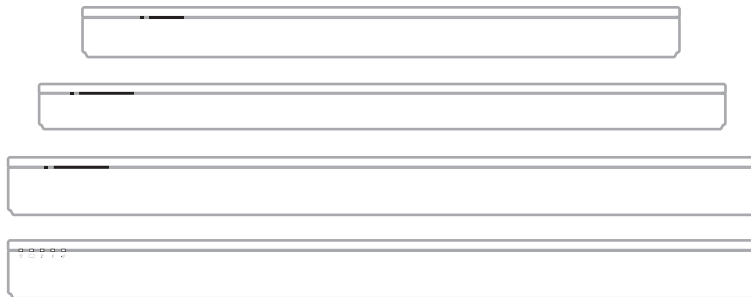

### **Escolher seu método de configuração**

Seu método de configuração depende da barra de som que você tem.

**Bose Soundbar 500, Bose Soundbar 700 ou Bose Smart Soundbar 300:**  
Consulte o método 1.

**Barra de som SoundTouch 300:** Consulte o método 2.

# MÉTODO 1

BOSE SOUNDBAR 500, BOSE SOUNDBAR 700, BOSE SMART SOUNDBAR 300

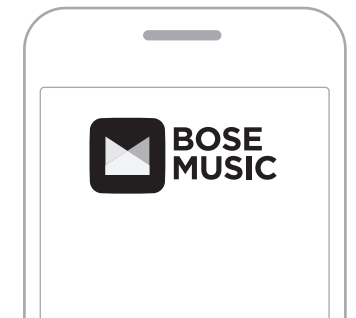

## **Configurar usando o aplicativo Bose Music**

- a. No aplicativo Bose Music, na tela Meus produtos, selecione a sua barra de som.
- b. Vá até o menu Configurações para adicionar os alto-falantes surround.

---

### **Novo no aplicativo Bose Music?**

Baixe o aplicativo e siga as instruções dele para configurar a barra de som e os alto-falantes surround.

## MÉTODO 2

### BARRA DE SOM SOUNDTOUCH 300

1

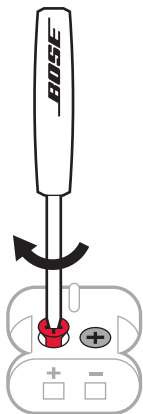

#### Conectar os adaptadores

- Insira os fios dos cabos codificados por cores do alto-falante nos terminais correspondentes.
- Gire os parafusos para a direita (sentido horário) para prender os fios nos terminais.
- Repita as etapas a e b para conectar o outro adaptador.

2

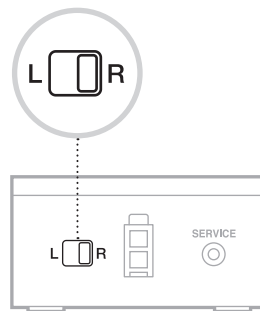

#### Identificar as configurações dos comutadores nos receptores sem fio

- Confirme que o comutador em um receptor sem fio está configurado para **R** (lado direito).
- Confirme que o comutador em um receptor sem fio está configurado para **L** (lado esquerdo).

## MÉTODO 2 (CONTINUAÇÃO)

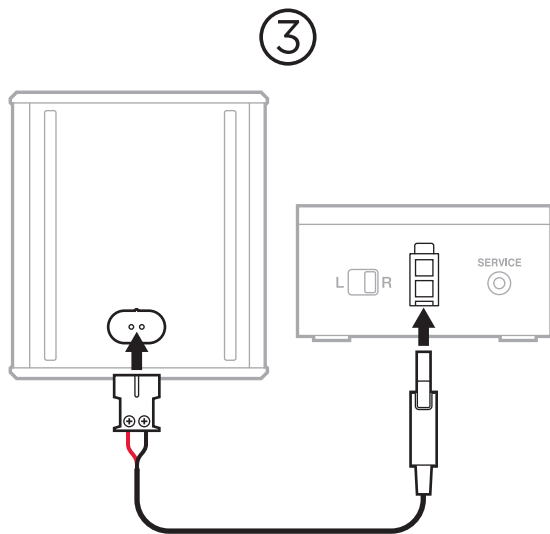

### Conectar os alto-falantes traseiros

- Insira o adaptador na parte traseira do alto-falante.
- Insira o conector de dois pontos no receptor sem fio.
- Repita as etapas 1 e 2 para configurar o outro alto-falante.

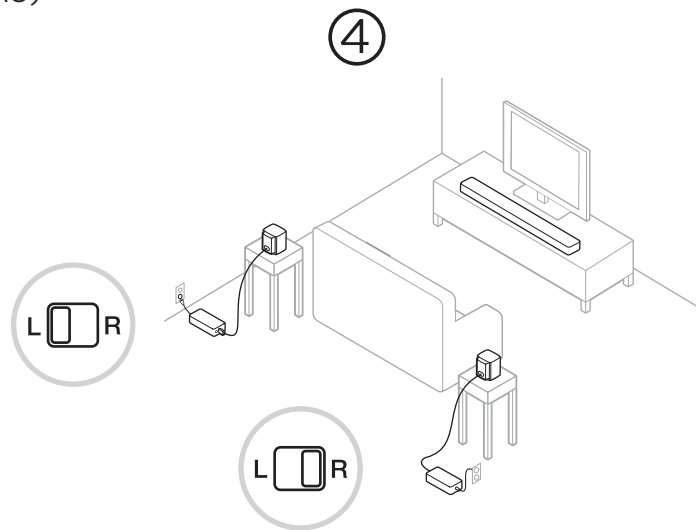

### Posicionar os alto-falantes traseiros e os receptores sem fio



- De frente para a TV, coloque o alto-falante e o receptor sem fio **R** no lado **direito** do ambiente.
- De frente para a TV, coloque o alto-falante e o receptor sem fio **L** no lado **esquerdo** do ambiente.
- Conecte à energia.

## MÉTODO 2 (CONTINUAÇÃO)

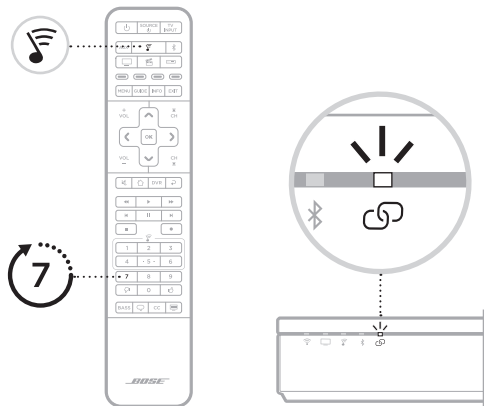
5



### Conectar os alto-falantes surround à barra de som

- No controle remoto da SoundTouch 300, pressione .
- Pressione 7 por alguns segundos, até  na barra de som piscar em branco. Quando o alto-falante surround se conectar, você ouvirá um som e  acenderá em branco.

**OBSERVAÇÃO:** O estabelecimento da conexão pode demorar vários minutos.

6

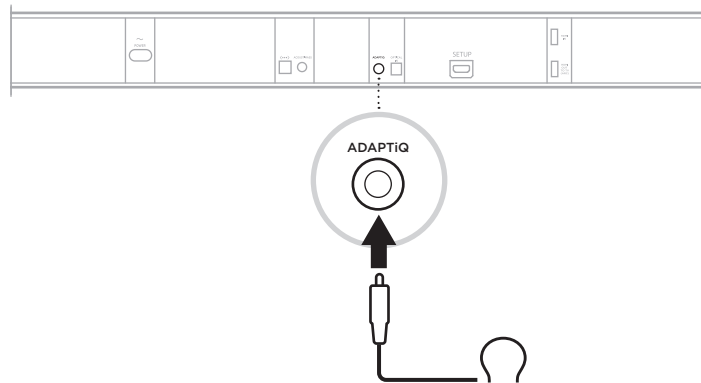

### Configurar a calibração de áudio ADAPTiQ

- Conecte o fone de ouvido ADAPTiQ (fornecido com a barra de som) ao conector ADAPTiQ da barra de som.
- Coloque o fone de ouvido em sua cabeça.



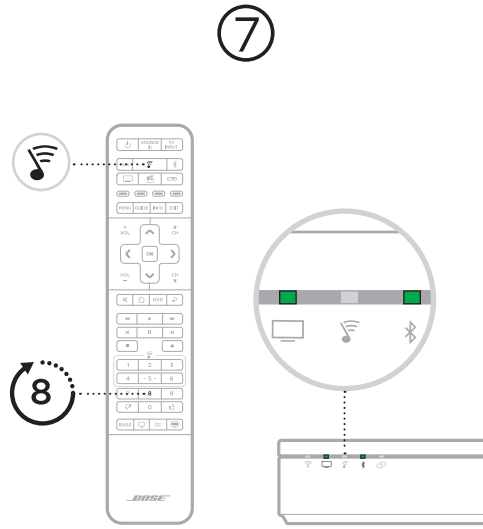

## MÉTODO 2 (CONTINUAÇÃO)





[worldwide.Bose.com/Support/WSS](https://worldwide.Bose.com/Support/WSS)



### Executar a calibração de áudio ADAPTiQ

- No controle remoto da SoundTouch 300, pressione .
- Pressione 8 por alguns segundos, até  e  na barra de som acenderem em verde.

**OBSERVAÇÃO:** Para navegar entre os idiomas, pressione  e  no painel de navegação.

# BÖRJA HÄR

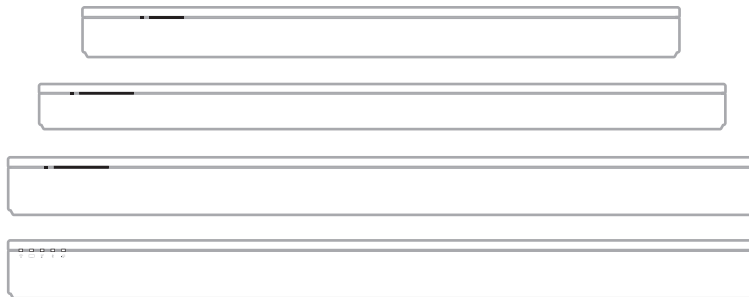

## Välja installationsmetod

Installationsmetoden beror på vilken högtalarpanel du har.

**Bose Soundbar 500, Bose Soundbar 700 eller**

**Bose Smart Soundbar 300:** Se metod 1.

**SoundTouch 300 soundbar:** Se metod 2.

## METOD 1

BOSE SOUNDBAR 500, BOSE SOUNDBAR 700, BOSE SMART SOUNDBAR 300



### Installation via Bose Music-appen

- a. Välj din soundbarhögtalare i Bose Music-appen från My Products-skärmen.
- b. Gå till inställningsmenyn för att lägga till surroundhögtalarna.

---

### Första gången med Bose Music-appen?

Ladda ner appen och följ instruktionerna för att ställa in soundbarhögtalaren och surroundhögtalarna.

## METOD 2

### SOUNDTOUCH 300-SOUNDBARHÖGTALARE

①

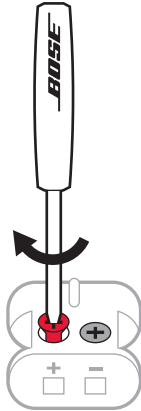

#### Anslut adaptrarna

- För in de färgkodade högtalarledningarna i motsvarande kontakter.
- Vrid skruvarna medurs för att fästa ledningarna i kontakterna.
- Upprepa steg a och b för att ansluta den andra adaptern.

②

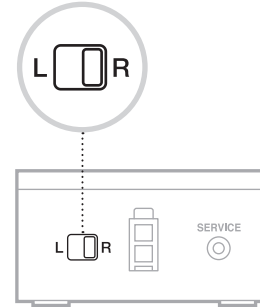

#### Identifiera inställningarna för omkopplaren på trådlösa mottagare

- Kontrollera att omkopplaren på en trådlös mottagare är inställd på **R** (höger).
- Kontrollera att omkopplaren på en trådlös mottagare är inställd på **L** (vänster).

## METOD 2 (FORTSÄTTNING)

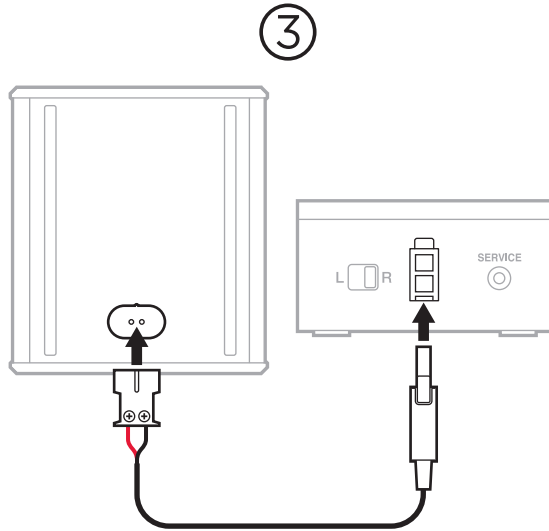

### Anslut bakre högtalare

- Sätt in adaptern på avsedd plats på baksidan av högtalaren.
- Sätt in 2-stiftskontakten i den trådlösa mottagaren.
- Upprepa steg 1 och 2 för att ställa in andra högtalare.

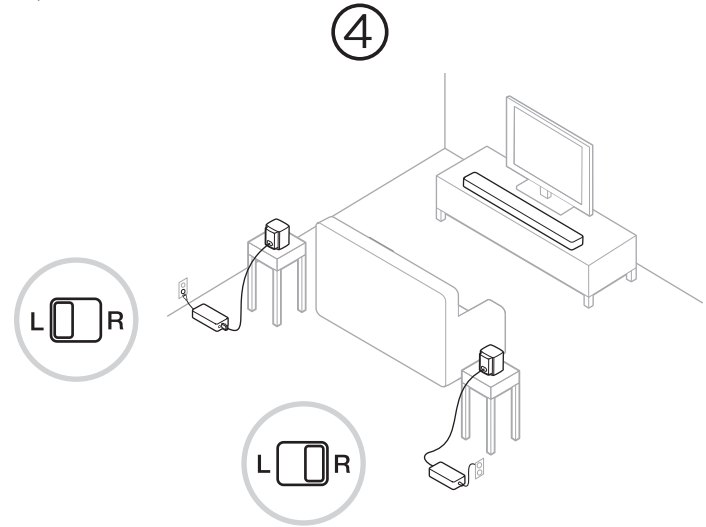

### Placera ut bakre högtalare och trådlösa mottagare



- Vänd dig mot TV:n och placera högtalaren och den trådlösa **R**-mottagaren på den **högra** sidan av rummet.
- Vänd dig mot TV:n och placera högtalaren och den trådlösa **L**-mottagaren på den **vänstra** sidan av rummet.
- Anslut till en strömkälla.

## METOD 2 (FORTSÄTTNING)

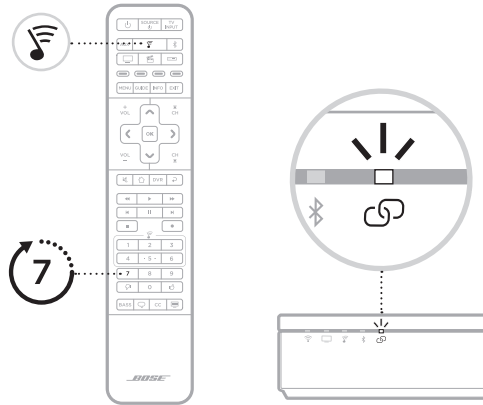
5



### Ansluta surroundhögtalarna till högtalarpanelen

- Tryck på  på fjärrkontrollen.
- Tryck ned 7 tills  på högtalarpanelen blinkar med vitt sken.  
När surroundhögtalaren är ansluten hörs en ton och  lyser vitt.  
**OBS:** Anslutningen kan ta flera minuter.

6

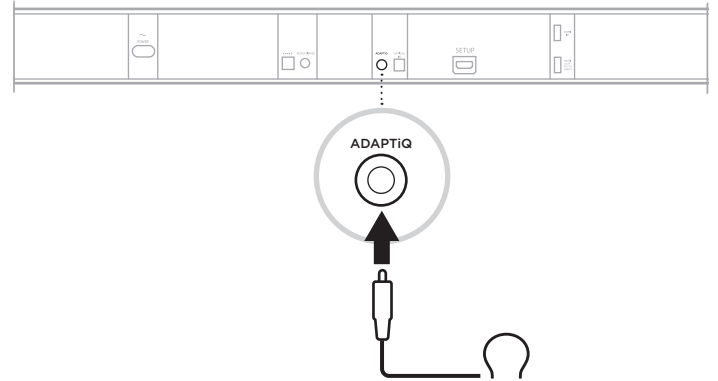

### Förbered för ADAPTiQ-ljudkalibrering

- Anslut ADAPTiQ-headsetet (som medföljer högtalarpanelen) till högtalarpanelens ADAPTiQ-anlutning.
- Sätt headsetet på huvudet.

## METOD 2 (FORTSÄTTNING)

7

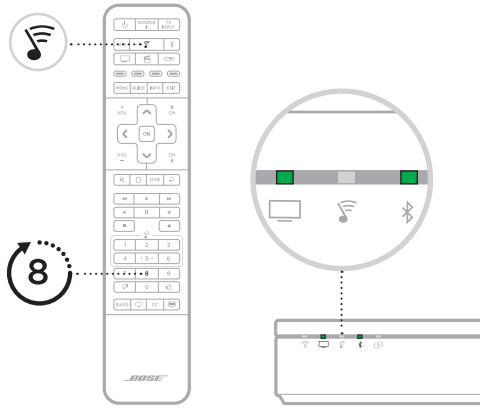





?

[worldwide.Bose.com/Support/WSS](https://worldwide.Bose.com/Support/WSS)



### Kör ADAPTiQ-ljudkalibrering

- Tryck på  på fjärrkontrollen.
- Tryck ned 8 tills  och  på högtalarpanelen lyser grönt.  
**OBS:** Tryck på  och  på navigeringsplattan för att välja rätt språk.



**[worldwide.Bose.com/Support/WSS](https://worldwide.Bose.com/Support/WSS)**



787798-0060