

marantz®

Model SA-10 Quick Start Guide

Super Audio CD Player

Welcome

Thank you for choosing a Marantz CD player. This guide provides step-by-step instructions for setting up your CD player.

Please do not return this unit to the store – call for assistance.

If you need help... :





If you need additional help in solving problems, contact Marantz customer service in your area.

For details, see the Marantz homepage.

www.marantz.com

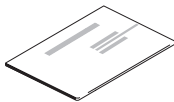
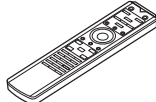
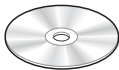
Before You Begin

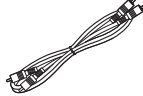
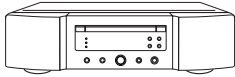
What's In the Box

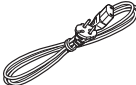
Quick Start Guide		Remote control unit	
Owner's Manual		R03/AAA batteries	
Safety Instructions		Audio cable	
CD Player		Remote connector cable	
Power cord			

Required for Basic connections

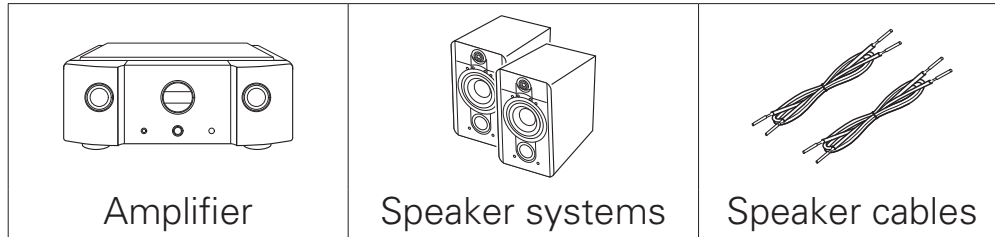

Optional

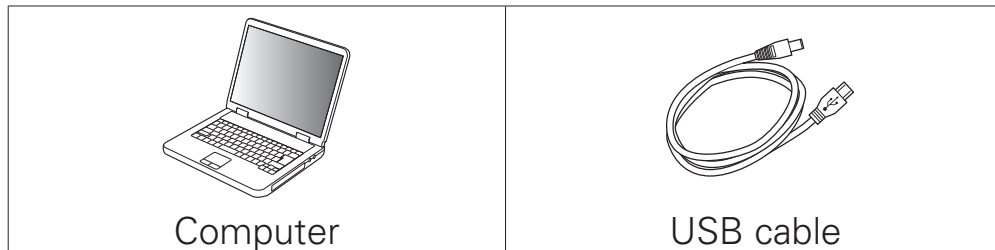

- These drawings are for illustrative purposes only and may not represent the actual product(s).

Setup

There are seven steps to the setup process.

- 1** Install batteries in the remote control unit
- 2** Connect the CD player to the amplifier
- 3** Plug the power cord into a power outlet
- 4** Turn the CD player's power on
- 5** Begin music playback
 - ▶ Play a CD or Super Audio CD
 - ▶ Play an iPod
 - ▶ Play from a USB memory device
- 6** Installing the Windows driver software
- 7** Enjoying music using PC or Mac

1 Install batteries in the remote control unit

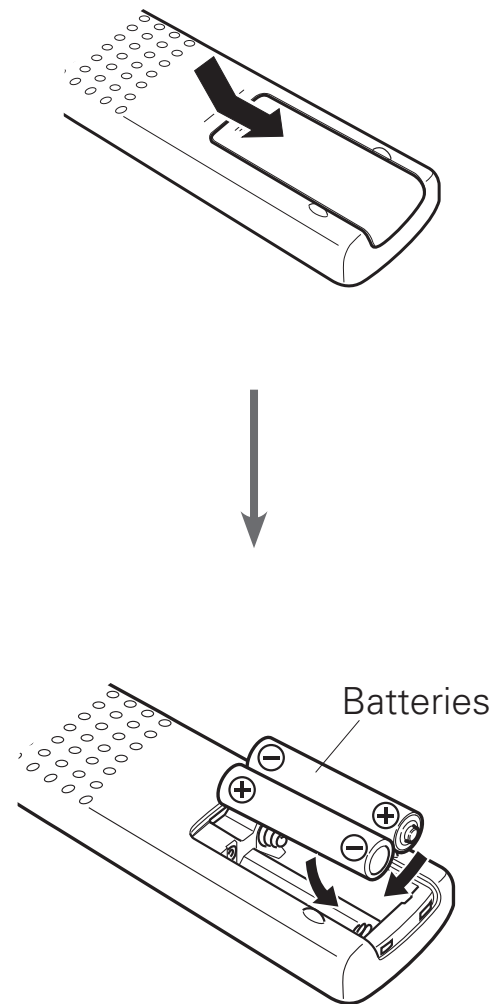

2 Connect the CD player to the amplifier

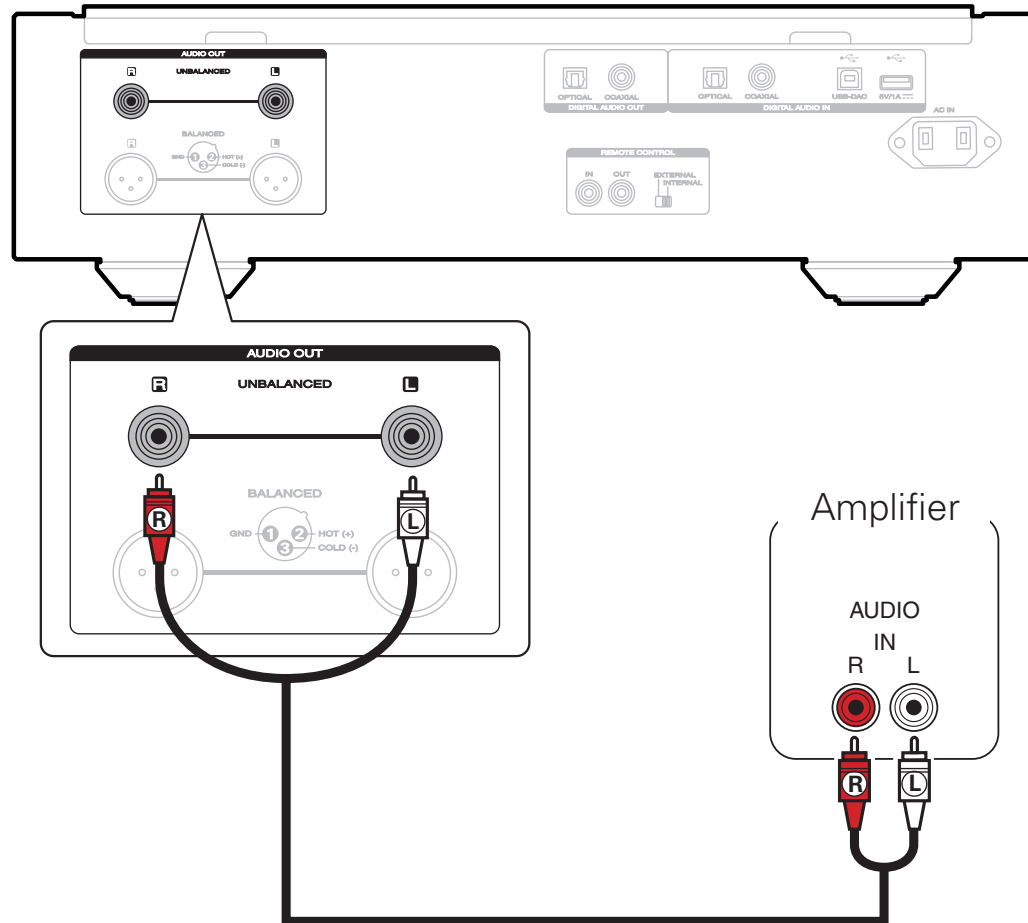

- This unit has both unbalanced and balanced connectors. The features of the balanced connectors are little effect of external noise and little shaking in the connector area. For details, see the included owner's manual.

3 Plug the power cord into a power outlet

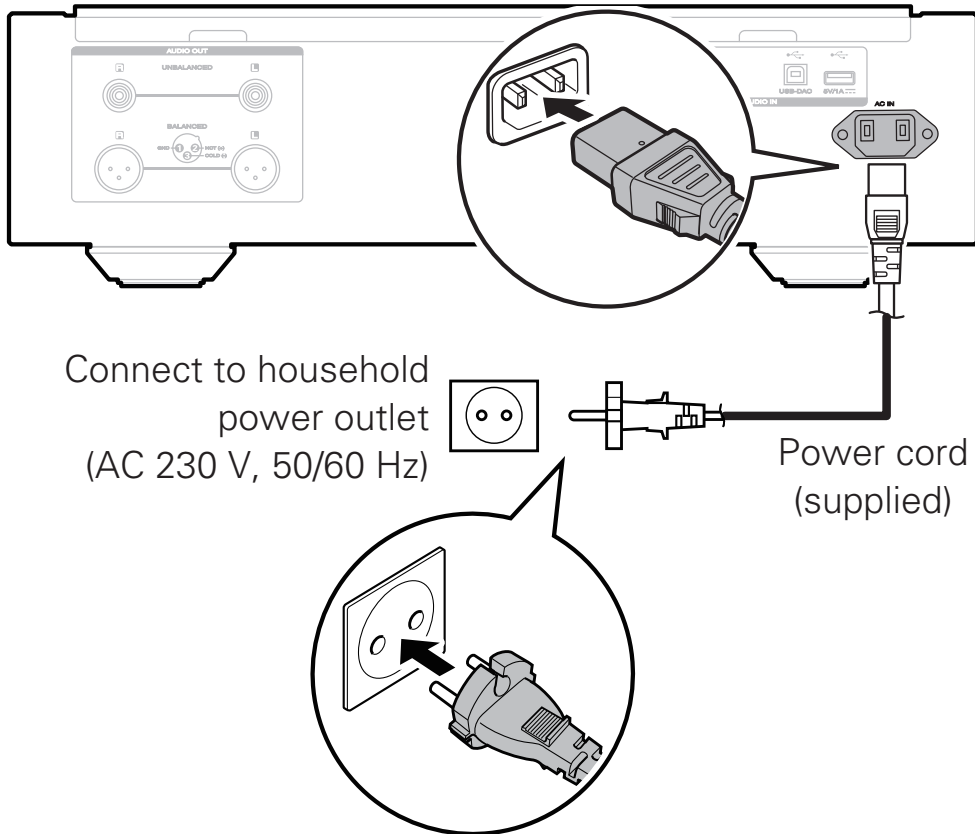

4 Turn the CD player's power on

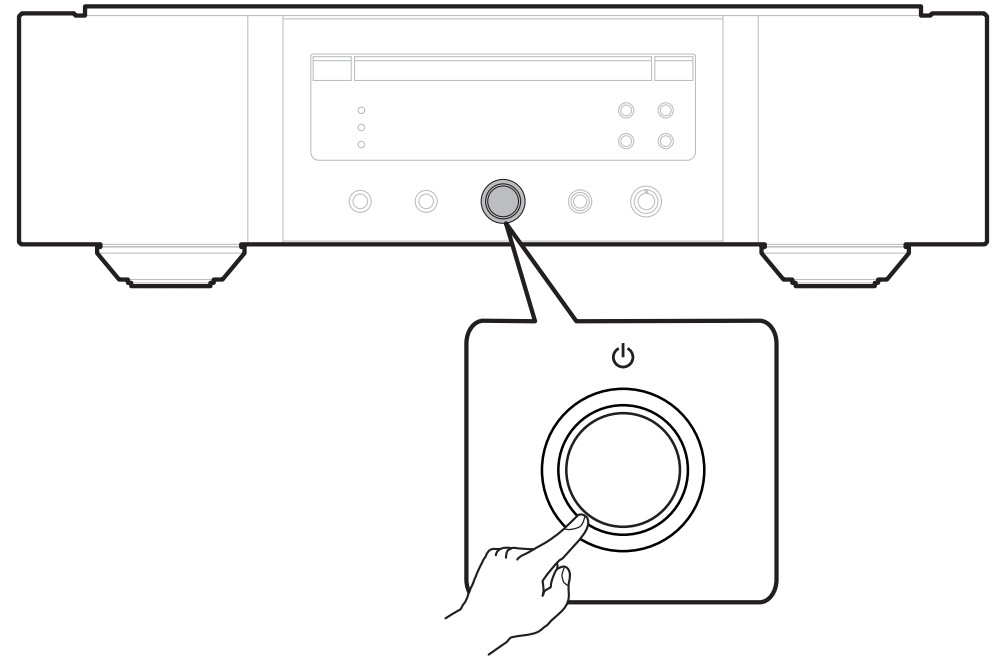

5 Begin music playback

▶ Play a CD or Super Audio CD

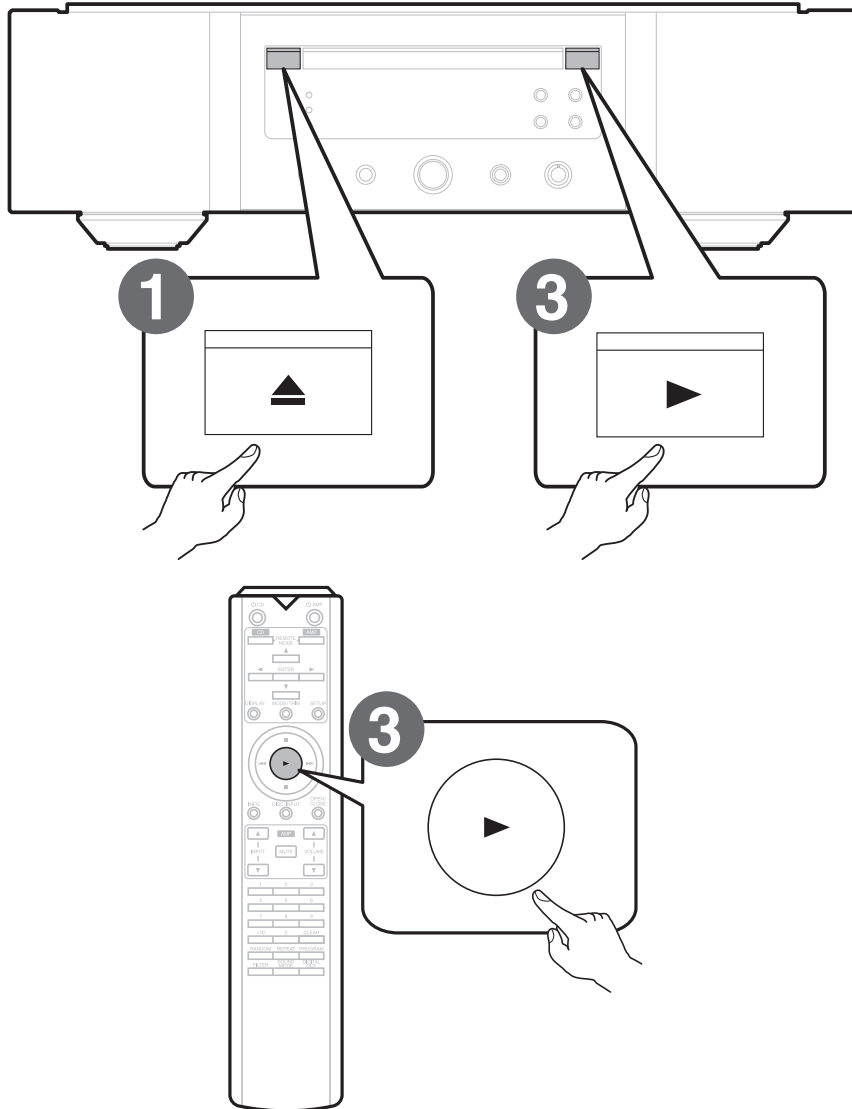

1 Press **▲** to open the disc tray.

2 Place CD in the disc tray.

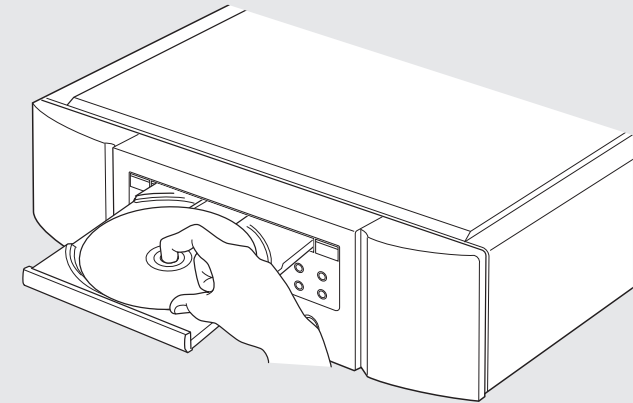

3 Press **▶**.
Playback starts.

▶ Play an iPod

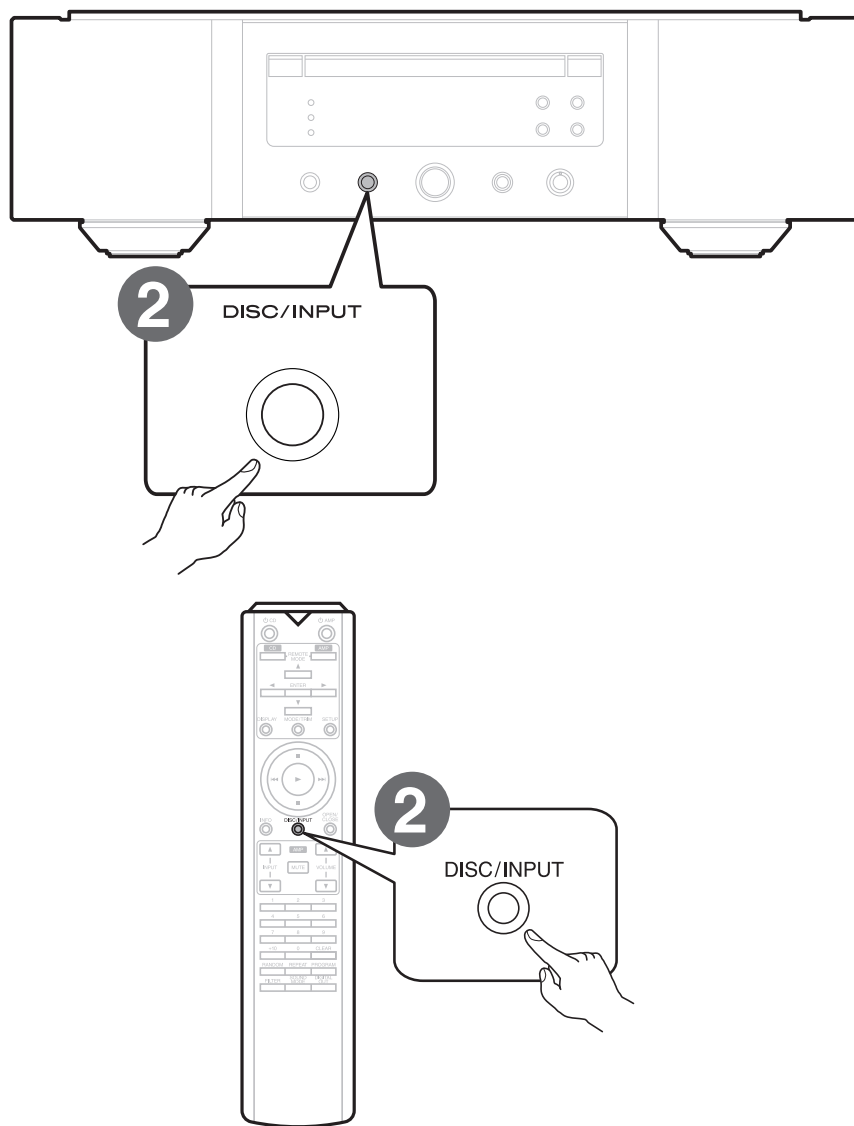

- 1 **Connect the iPod to the USB port.**

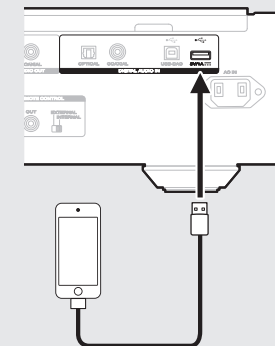

- 2 **Press DISC/INPUT to select the playback media mode to “iPod/USB”.**



- You can also select the playback media mode by pressing DISC/INPUT on the unit.

- 3 **Operate iPod itself directly while seeing the iPod screen to play back music.**

Playback starts.

▶ Play from a USB memory device

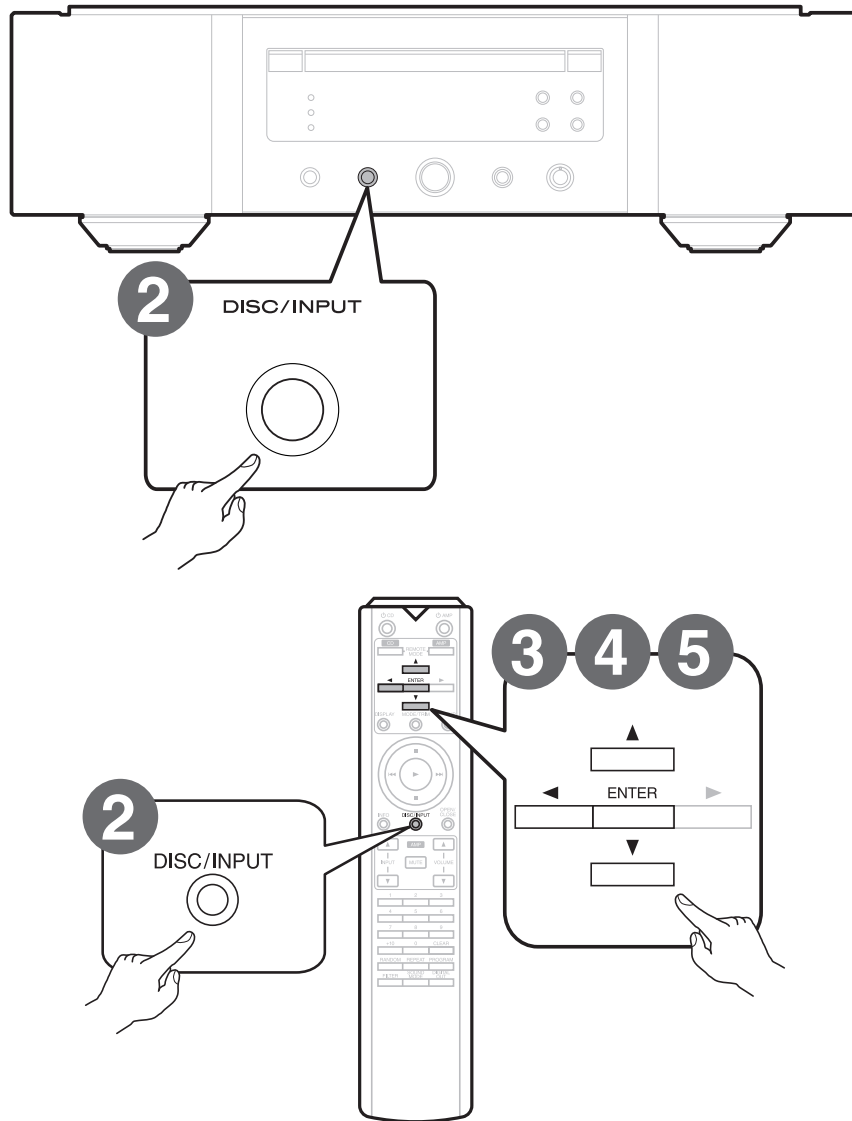

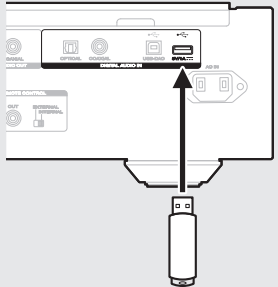
- 1** Connect the USB memory device to the USB port.
 
- 2** Press **DISC/INPUT** to select the playback media mode to “iPod/USB”.
 - You can also select the playback media mode by pressing DISC/INPUT on the unit.
- 3** Press **◀**.
The file/folder list appears in the display of this unit.
- 4** Use **△▽** to select the folder, then press **ENTER**.
- 5** Use **△▽** to select the file, then press **ENTER**.
Playback starts.

6 Installing the Windows driver software

NOTE

The installation of the driver software is not necessary in the following cases.

- When you do not play back the music from a PC using USB-DAC of this unit.
- When using a Mac OS.

1 Download the dedicated driver from the “Download” section of the SA-10 page of the Marantz website (<http://www.marantz.com/pages/home.aspx>) onto your PC.

2 Unzip the downloaded file, and double-click the exe file.

3 Install the driver.

- ① Select the language to use for the installation.
- ② Click “OK”.

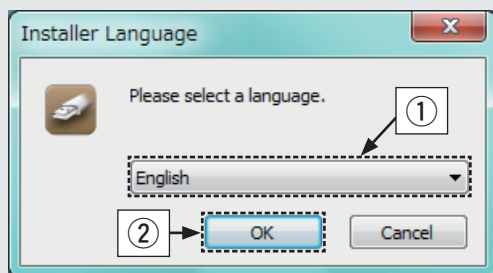

- ③ The wizard menu is displayed. Follow the instructions on the screen.

- ④ When the wizard is completed, click “Yes”.

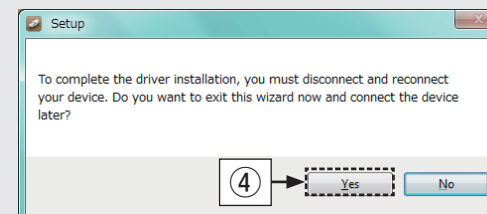

NOTE

- The driver software cannot be installed correctly if your PC is connected to the unit by a USB cable.
- If the unit and your computer are connected by a USB cable and the computer is switched on before installation, disconnect the USB and restart the computer.
- Please see the FAQ at www.marantz.com if you experience any issues getting audio to play from your computer through the SA-10. You may also want to check the support pages for your audio player application.

7 Enjoying music using PC or Mac

❑ Connect to PC or Mac

1 Connect to PC or Mac.

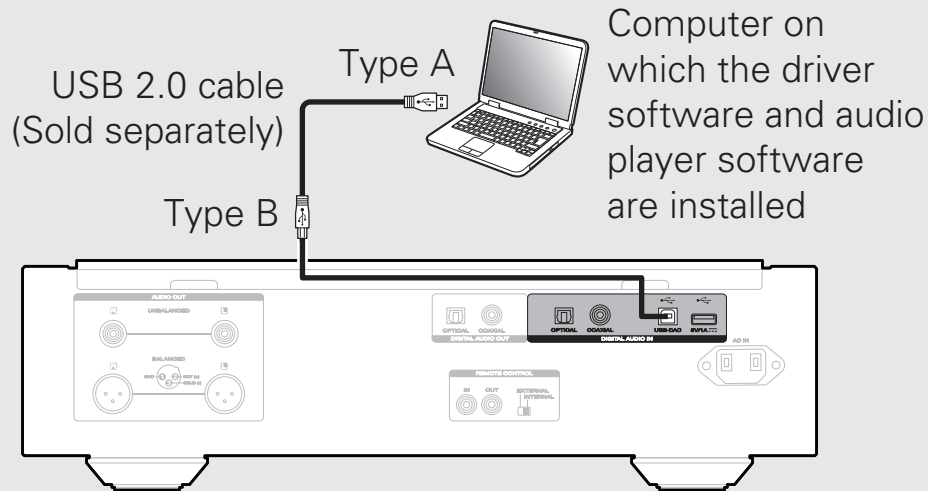

2 Press on this unit.

- When the unit power is turned on, the computer automatically finds and connects to the unit.

❑ Listen to PC or Mac Audio

1 Press DISC/INPUT to change the playback media mode to “USB-DAC”.



2 Set the audio signal destination to this unit on the computer.

System Requirements

- Windows 7, Windows 8, Windows 8.1 or Windows 10
- Mac OS X 10.9, 10.10 or 10.11

[Windows OS]

- ① Click the “Start” button and click “Control Panel” on the PC.
 - The control panel setting list is displayed.
- ② Click the “Sound” icon.
 - The sound menu window is displayed.

- ③ Check that there is a checkmark next to “Default Device” under in “SA-10S1” of the “Playback” tab.
 - When there is a checkmark for a different device, click “SA-10S1” and “Set Default”.
- ④ Select “SA-10S1” and click “Properties”.
 - The SA-10S1 Properties window is displayed.

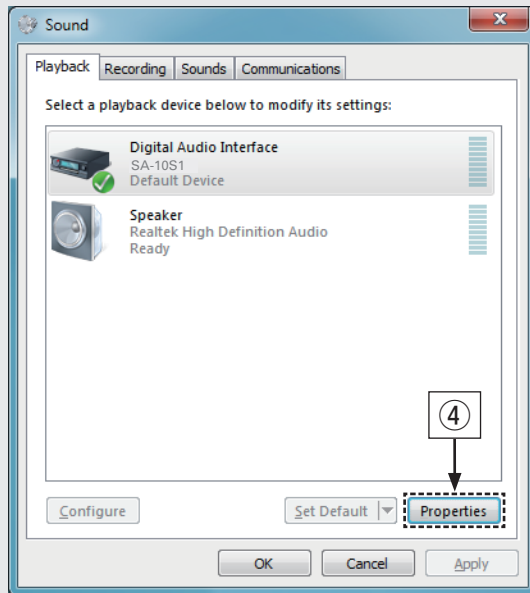

- ⑤ Click the “Advanced” tab.
- ⑥ Select the sampling rate and bit rate to be applied to the D/A converter.
 - It is recommended that “2 channel, 24 bit, 192000 Hz (Studio Quality)” is selected. (Windows 7)
 - It is recommended that “2 channel, 32 bit, 192000 Hz (Studio Quality)” is selected. (Windows 8/Windows 8.1/Windows 10)
- ⑦ Click “Apply”.
- ⑧ Click “Test”.
 - Check that audio from this unit is output from the PC.

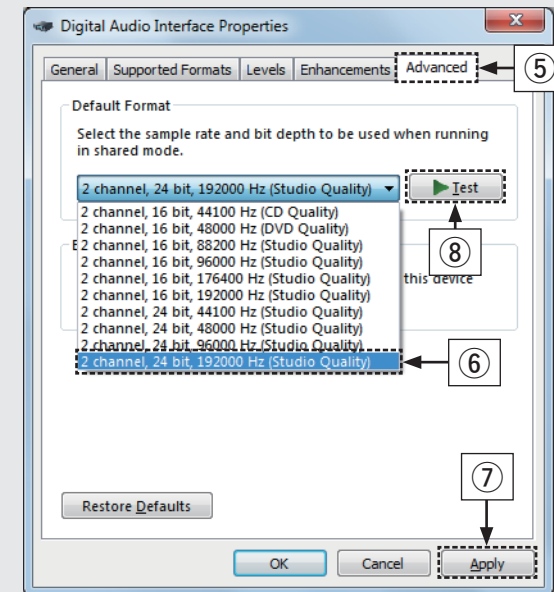

[Mac OS X]

- ① Move the cursor to "Go" on the computer screen, and then click "Utilities".
 - The utility list is displayed.
- ② Double-click "Audio MIDI Setup".
 - The "Audio Devices" window is displayed.
- ③ Check that "Use this device for sound output" is checked in "SA-10S1".
 - If a different device is checked, select and "Secondary click" on "SA-10S1", and then select "Use this device for sound output".

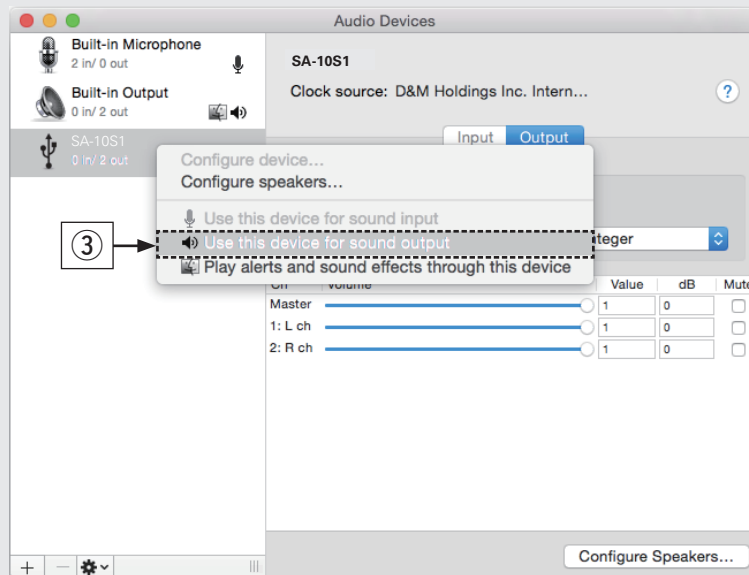

- ④ Select the "SA-10S1" format.
 - It is normally recommended to set the format to "384000.0 Hz" and "2ch-32 bit Interger".

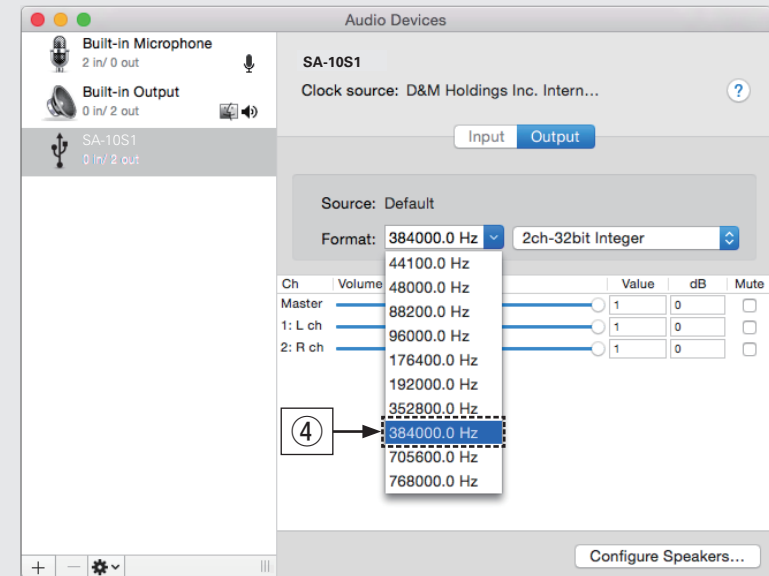

- ⑤ Click "Quit Audio MIDI Setup".

3 Use your favorite music applications on your PC/Mac to play audio through the SA-10.

- For high resolution audio playback you will need to obtain an advanced audio player software such as JRiver Media Center or Audirvana.

USB : DSD11.2M

The sampling frequency of the music file is displayed.

NOTE

- Additional settings to output audio to the SA-10 may have to be selected in your advanced audio player application. Please refer to the user's manual for your application.

Owner's Manual

Please reference to the Owner's Manual for more details about the setup and operation of the CD player and its features.

❏ Online Version

Enter the following URL into your web browser:
manuals.marantz.com/SA10/EU/EN/



Online Manual

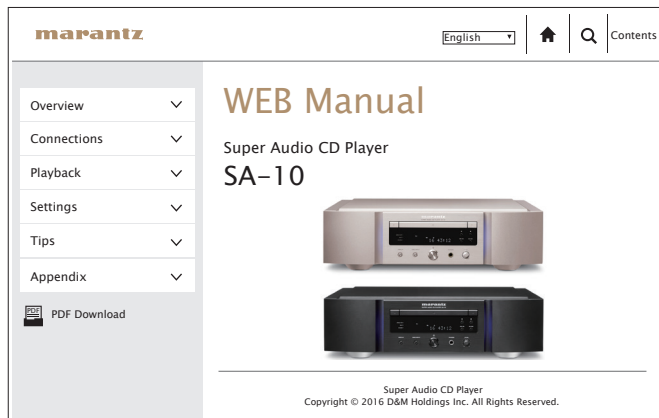

❏ Printable Version

Access the print version of the owner's manual from the included CD-ROM or select the "PDF Download" link from the Online Version.

1

Insert the disc into your PC.

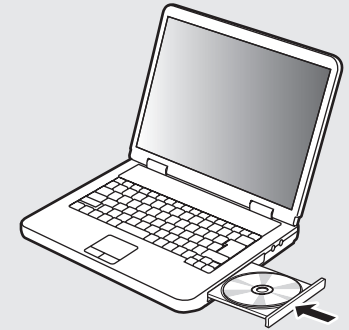

2

Follow the screen or double click on the PDF file.

www.marantz.com

You can find your nearest authorized distributor or dealer on our website.

marantz[®] is a registered trademark.