



User Guide

Version 1.1

SUMMIT



Novation
A division of Focusrite Audio Engineering Ltd.
Windsor House
Turnpike Road
Cressex Business Park
High Wycombe
Buckinghamshire
HP12 3FX
United Kingdom

Tel: +44 1494 462246

Fax: +44 1494 459920

e-mail: sales@novationmusic.com

Web: novationmusic.com

Trade marks

The Novation trade mark is owned by Focusrite Audio Engineering Ltd. All other brand, product and company names and any other registered names or trade marks mentioned in this manual belong to their respective owners.

Disclaimer

Novation has taken all possible steps to ensure the information given here is both correct and complete. In no event can Novation accept any liability or responsibility for any loss or damage to the owner of the equipment, any third party, or any equipment which may result from use of this manual or the equipment which it describes. The information provided in this document may be modified at any time without prior warning. Specifications and appearance may differ from those listed and illustrated.

COPYRIGHT AND LEGAL NOTICES

Novation is a registered trade mark of Focusrite Audio Engineering Limited.

Peak and New Oxford Oscillator are trade marks of Focusrite Audio Engineering Limited.

2019 © Focusrite Audio Engineering Limited. All rights reserved.

CONTENTS

INTRODUCTION	4	The LFO Section	30
Key Features	4	LFO 1 and LFO 2 hardware controls	30
About This Manual	4	LFO 1 & 2 Waveform	31
What's in the box	4	LFO 1 & 2 Rate	31
Registering your Novation Summit	4	LFO 1 & 2 Fade Time	31
Power Requirements	4	LFO 3 and LFO 4 hardware controls	31
HARDWARE OVERVIEW	5	LFO 3 & 4 Select	31
Top Panel	5	LFO 3 & 4 Waveform	31
Controls, section by section	5	LFO 3 & 4 Rate	31
Rear Panel	9	LFO 3 & 4 Sync	31
GETTING STARTED	10	The LFO Menu	31
Menu Navigation	12	The Arpeggiator	33
Bi-timbral synthesis	12	Tempo	33
Loading Patches	12	Arp Mode	33
Comparing Patches	13	Arp Rhythm	33
Quick Initialisation	13	Octave range	33
Saving Patches	14	Note duration	33
Basic Operation – sound modification	14	Key Latch	33
The OLED display	14	Arp data transmission	33
Parameter adjustment	14	The Arp/Clock Menu	33
The Filter knob	14	The Effects Section	35
Keyboard controls	15	Distortion	35
The Arpeggiator	15	Chorus	35
MIDI control	15	Delay	35
The Animate Buttons	15	Reverb	35
SYNTHESIS TUTORIAL	16	The FX Menu	35
SUMMIT: SIMPLIFIED BLOCK DIAGRAM	21	The Modulation Matrix	38
SUMMIT IN DETAIL	22	The FX Modulation Matrix	39
Voices	22	The Settings Menu	40
Glide	22	APPENDIX	45
The Voice Menu	23	System Updates using Novation Components	45
The Oscillator Section	25	Patch import via SysEx	45
Oscillator Waveform	25	Sync values tables	45
Oscillator Pitch	25	Arp/Clock Sync Rate	45
Pitch Modulation	25	Delay Sync Rate	45
Waveform Shape	25	LFO Sync Rate	45
The Oscillator Menu	25	List of Wavetables	45
The Mixer Section	27	MIDI operation in Single and Multi Patch modes	46
The Filter Section	27	Modulation Matrix – sources	46
Filter type and slope	27	Modulation Matrix – destinations	46
Resonance	28	Modulation Matrix – destinations continued	46
Filter modulation	28	FX Modulation Matrix – sources	46
Filter tracking	29	FX Modulation Matrix – destinations	46
Overdrive	29	MIDI parameters list	47
The Envelopes Section	29	Sound designers	49
The Envelopes Menu	30	List of factory Patches with designer credits	50

INTRODUCTION

Thank you for purchasing this Summit sixteen voice polyphonic, bi-timbral synthesiser, the best sounding synth Novation has ever made. Summit is the natural development of our Peak desktop synth, which was itself conceived as a polyphonic version of the Bass Station II analogue synth. Summit is essentially a two-part, multi-timbral hybrid instrument built around a dual implementation of Peak's synth core. Based on Peak's New Oxford Numerically Controlled Oscillators, Summit's two part structure gives you unrivalled control of sound design in both 16-voice single mode and 2 x 8-voice bi-timbral mode. You can bring multiple, layered sounds into the mix, while retaining full control of every aspect of each synth engine. We have also included a great effects section to help add further colour and depth to Summit's sounds.

As well as superlative sound quality, Summit gives you two great sets of specially-created presets – single patches, as implemented on Peak, and some stunning new multi patches, which harness the full power of Summit's bi-timbral architecture.

Summit has a high quality, 61-note keyboard with Pitch and Mod wheels. You can use it in the studio or on stage, either stand-alone or with the MIDI controller of your choice, be it a another keyboard, DAW or a pad controller such as the Novation Launchpad Pro. It has a CV (Control Voltage) input to let you interface with Eurorack and other CV-capable synths you may already have.

NOTE: Summit is capable of generating audio with a large dynamic range, the extremes of which can cause damage to loudspeakers or other components, and also to your hearing!!

Key Features

- Two part, multi-timbral architecture with Layer, Split and Dual keyboard modes
- FPGA-based Numerically Controlled Oscillators running at 24 MHz generate waveforms indistinguishable from those produced by analogue oscillators
- Traditional analogue signal paths
- Fully analogue filter section
- Dual Peak architecture: all parameters for each Part are independently accessible
- Traditional, dedicated function rotary controls
- 16-voice polyphony
- Three oscillators per voice, per-Part
- Sine, triangle, sawtooth and pulse waveforms, plus 60 wavetables, per oscillator
- 10 user-configurable wavetable slots
- Waveform shaping on all waveform types
- Tuning Table function – allows creation of non-standard keyboard tunings
- Two analogue LP/BP/HP filters with variable slope, resonance, overdrive and modulation options
- Any two filter types may be used simultaneously: separation parameter allows different frequencies
- Powerful 16-slot Modulation Matrix with two sources per slot
- Two full LFOs with panel controls
- Two further LFOs with primary controls on panel plus menu control of other parameters: fully routable via the Modulation Matrix
- Three Envelope sections (Amp and 2 x Mod) with six phases: DAHDSR
- Traditional fader controls for ADSR phases of Amp and Mod envelopes
- AHD envelope phases can be looped repeatedly from panel
- Ring Modulator (inputs: Oscs 1 and 2)
- Versatile arpeggiator with wide range of patterns and modes: primary controls on panel
- Glide (portamento) with dedicated time control
- Pre-loaded with brand new Patches: 384 Single Patches and 384 Multi Patches, each arranged as three banks of 128
- Two further User banks for 128 additional Single Patches and 128 additional Multi Patches
- Full compatibility with Patches created on Novation Peak: Peak's Patch banks, or individual Patches, can be imported to Summit via SysEx.
- Two Animate buttons for triggering instant sound modifications and effects in live performance
- Powerful FX section: distortion, delay, chorus and reverb
- Separate 4-slot FX Modulation Matrix
- Class-compliant USB port (no drivers needed), patch dump and MIDI
- OLED display for patch selection and parameter adjustment
- Internal universal PSU – mains powered
- External CV input for integration with other analogue equipment
- Two sets of stereo outputs for main and auxiliary output routing: each Part may be routed to either/both
- Headphone output: can follow main, auxiliary or both outputs
- Supports any two pedals – sustain or expression
- Kensington Security Slot

About This Manual

IMPORTANT:

This User Guide is applicable to Summit synthesisers with v1.1 firmware. If your Summit has an earlier firmware version, we recommend that you update it to the latest version, which can be done using Novation Components: please go to novationmusic.com/components.

We've tried to make this manual as helpful as possible for all types of user, and this inevitably means more experienced users will want to skip over certain parts of it, while those with a bit less synth experience will want to avoid certain parts of it until they're confident they've mastered the basics. As with other Novation synthesiser User Guides, we've included a "Synthesis Tutorial" (see page 16) which explains the principles of sound generation and treatment that are the foundation of all synthesisers. We think this will be of help and interest to everyone.

There are a few general points that are useful to know before you continue reading this manual. We've adopted some graphical conventions within the text, which we hope you will find helpful in navigating through the information to find what you need to know quickly:

Abbreviations, conventions, etc.

Where top panel controls or rear panel connectors are referred to, we've used a number thus: **1** to cross-reference to the top panel diagram, and thus: **①** to cross-reference to the rear panel diagram. (See page 5 and page 9).

We've used **BOLD TEXT (or Bold Text)** to name top panel controls or rear panel connectors; we've made a point of using exactly the same names as appear on Summit itself. We've used `Dot Matrix text` to illustrate text and numbers that appear on the top panel display.

Tips



These do what it says on the tin: we include bits of advice, relevant to the topic being discussed that should simplify setting up Summit to do what you want. It's not mandatory that you follow them, but generally they should make life easier.

Extra Info



These are additions to the text that will be of interest to the more advanced user and can generally be avoided by the less experienced. They are intended to provide a clarification or explanation of a particular area of operation.

What's in the box

Your Summit synthesiser has been carefully packed in the factory and the packaging was designed to withstand rough handling. Should the unit appear to have been damaged in transit, do not discard any of the packing material and notify your music dealer.

If practical, save all the packing materials in case you ever need to safely transport your Summit.

Please check the list below against the contents of the packaging. If any items are missing or damaged, contact the Novation dealer or distributor where you purchased the unit.

- Summit synthesiser
- IEC mains cable, with a plug appropriate for your territory
- USB cable, A-type to B-type, 1.5 m
- Safety information sheet
- "Getting Started" Guide, also providing online access to Ableton Live Lite

Registering your Novation Summit

You can register your Summit online at novationmusic.com/register, using the information provided in the Getting Started Guide. This will allow you to download the additional software you are entitled to as a Summit owner from your Novation account.

Power Requirements

Summit is AC mains powered: the internal power supply unit (PSU) is a "universal" type, and the synthesiser will operate on all mains voltages between 100 V and 240 V. An IEC mains cable is supplied with the unit.

Summit has no user-accessible fuses. In the event of an apparent PSU failure, Summit should only be repaired by a suitably qualified technician.

HARDWARE OVERVIEW

Top Panel

Summit's control surface is divided logically into functional areas, with signal generation and treatment broadly following a left-to-right sequence.



- MASTER – load Patches and adjust overall sound level; display of active voices
- ACTIVE VOICES – LED display indicating which voices are generating the current sound
- MULTIPART CONTROL – determine how the two Parts of a Multi Patch are controlled
- MULTIMODE – determine whether the two Parts of a Multi Patch are to be played together or individually
- ANIMATES – momentary buttons for instant sound modification
- Performance controls – Pitch/Mod wheels, octave control
- MENU – 4 x 20 character display for Patch selection/saving, extended parameter control and adjustment of global settings
- VOICE – selects voice mode and enables a glide between successive notes
- ARP – arpeggiator function: generates repeating note patterns
- OSCILLATOR 1 – Primary sound generator
- OSCILLATOR 2 – Primary sound generator
- OSCILLATOR 3 – Primary sound generator
- FM – controls inter-oscillator frequency modulation
- MIXER – sums oscillator waveforms, ring modulator output and noise
- FILTER – modifies frequency content of signal
- AMP ENVELOPE – controls how signal amplitude varies with time
- MOD ENVELOPES - controls how other synth parameters vary over time
- LFO 1 – low frequency oscillator, modulates filter and oscillator Shape
- LFO 2 – low frequency oscillator, modulates the pitch of Oscs 1, 2 & 3
- LFO 3 & 4 – low frequency oscillator, global controls only (others via menu system)
- DISTORTION – controls pre-VCA analogue distortion
- EFFECTS – add delay, reverb and chorus effects to overall sound

Controls, section by section

MASTER:

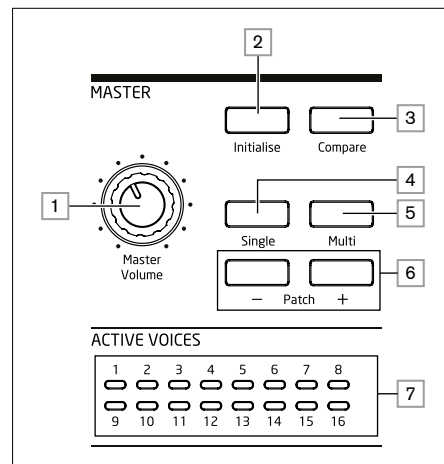

- 1 Master Volume** – master volume control for the synth's **MAIN** and **AUX** audio outputs; this also controls the headphones output level.
- 2 Initialise** – by default, you can press this button to reset all synth parameters to the default values of the Initial Patch. This provides a rapid way back to a bare "starting point" for fresh sound creation. The function of **Initialise** can be changed in the **Settings** Menu so all current control panel settings are applied to the Initial Patch when it is loaded: see page 42.
- 3 Compare** – press (and hold) this button to hear the original version of the currently loaded Patch. This allows you to compare the effects of any tweaking you've done since loading it with the original version. When a Multi Patch is selected, pressing **Compare** will let you hear both Parts A and B of the Patch, regardless of the Part currently selected by the A and B buttons [12]. Note that **Compare** can only be selected if keys are not being pressed at the same time.
- 4 Single** – press to access the Patch memory area reserved for Single Part Patches. The current Patch location and name will be shown in the display and alternative Single Patches may be selected with the parameter control [4].
- 5 Multi** – press to access the Patch memory area reserved for Multi Part Patches. The current Patch location and name will be shown in the display and alternative Multi Patches may be selected with the parameter control [5].
- 6 Patch +/-** – these buttons provide an alternative method of scrolling through Patches – Single or Multi, depending on the mode selected.
- 7 Active Voice** – sixteen bicolour LEDs, indicating which of the sixteen voices are currently active. All LEDs are orange in Single Patch Mode, while orange and blue are used in Multi Patch mode to indicate voice usage per Part.

MENU:

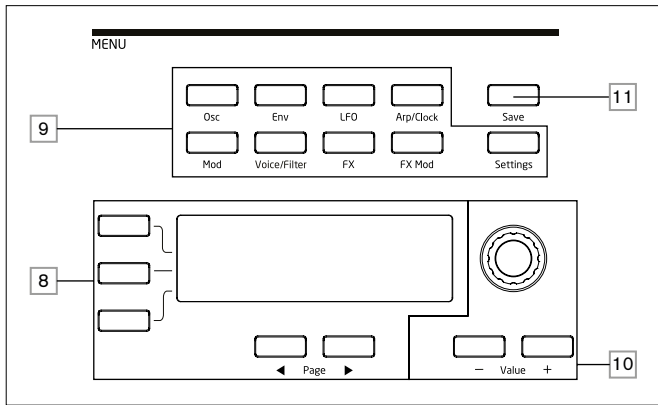

8 20 character x 4 row OLED display. Displays one of the menus selected by the buttons **9**, or the current Patch details. Pages within each menu may be selected with the **Page** (and **Page**) buttons below the display. Adjusting any of Summit's rotary controls (except **MASTER**) invokes an alternative display showing the value of the parameter being adjusted until the control is released. The three buttons to the left of the display assign the parameter control **10** to a particular row of the page being displayed.

9 Nine buttons selecting the menu to be displayed: **Osc**, **Env**, **LFO**, **Arp/Clock**, **Mod**, **Voice**, **FX**, **FX Mod** and **Settings**. These buttons are all "toggles": press them a second time to exit the menu; the display will revert to the Patch information page.

10 Parameter adjustment may either be made rapidly by the rotary control or incremented/decremented one parameter value at a time with the **Value + / Value -** buttons. These controls can also be used to scroll through the Patch library (Single or Multi, as currently active) if the display is currently showing Patch data and Row 2 ('Patch') is selected.

11 **Save** - opens the first of three menu pages, which enable the current synth settings to be saved as a User Patch in memory.

MULTIPART and MULTIMODE CONTROL :

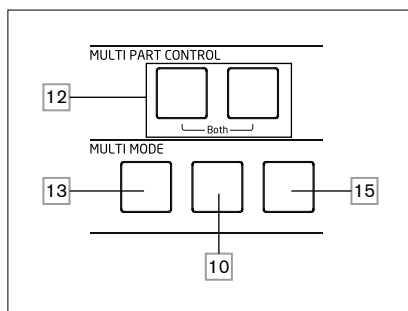

12 The **A** and **B** buttons select which Part - A or B - of a Multi Patch is assigned to the synth controls, and in **Dual** mode (see **15** below), which Part you hear. **A** and **B** may be pressed together to select **Both** mode, when the synth controls will affect both Parts simultaneously.

13 **Layer** - in Layer mode, the keyboard plays both Parts A and B of a Multi Patch.

14 **Split** - this mode lets you play Part A with the left hand and Part B with the right. The "split point" is, by default, middle C (C3). The split point can be redefined by pressing and holding **Split** while pressing the appropriate key on the keyboard; the new split point will be saved with the Patch.

15 **Dual** - in this mode, the whole keyboard is assigned to either Part A or Part B, selected by the **A** and **B** buttons **12**. Both Parts may be selected by pressing **A** and **B** together; in this case, the result is the same as selecting Layer mode. In this mode, you can control the parameters of both Parts of a Multi Patch simultaneously.



You can use Dual mode to just play one of the two Parts if you need to use the FX section for the other Part to process an external signal instead.

NOTE: In Multi Patch Mode, the above buttons **12** to **15** are internally illuminated: the colour reflects the Part currently assigned to Summit's synth controls. Part A is indicated by blue, Part B by orange and the A+B Both mode by white.

OSCILLATORS:

The three Oscillators have identical sets of controls.

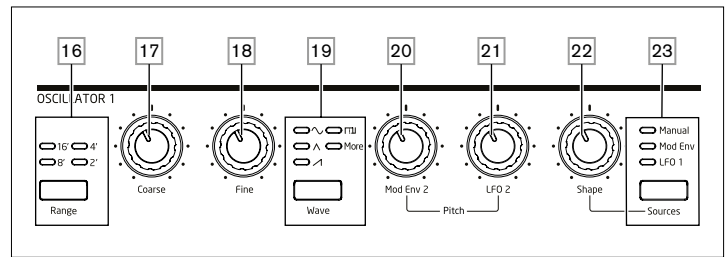

16 **Range** - steps through the oscillator's base pitch ranges. For standard concert pitch (A3 = 440 Hz), set to **8'**.

17 **Coarse** - adjusts the pitch of the selected oscillator over a range of ± 1 octave.

18 **Fine** - adjusts the oscillator pitch over a range of ± 100 cents (± 1 semitone).

19 **Wave** - steps through the range of available oscillator waveforms - sine, triangular, sawtooth, pulse and **more** (the menu offers an extensive set of additional wavetables for **more**).

20 **Mod Env 2 Depth** - controls the amount by which the oscillator pitch changes as a result of modulation by Envelope 2. All Modulation Depth controls are "centre-zero" and thus positive values will increase the pitch and negative values will decrease the pitch.

21 **LFO 2 Depth** - controls the amount by which the oscillator pitch changes as a result of modulation by LFO 2. Pitch changes are bi-polar (up and down); uni-polar pitch modulation is available by the use of the Modulation Matrix.

22 **Shape Amount** - controls further modifications of the waveform shape, and is active for all wave shapes. With pulse waves, it adjusts the pulse width; with sine, triangle and sawtooth waves it produces waveshaping, which imparts additional harmonics to the basic waveform. When **more** is selected by the **Wave** switch **19** and **Source** **23** is set to **Manual**, the control navigates continuously through the five waveforms of the wavetable currently selected for the **Waveform** parameter in the Oscillator menu.

23 **Source** - assigns the **Shape Amount** control **22** to one of three sources which further alter the waveform shape. The options are: modulation by Envelope 1 (**Mod Env 1**), modulation by LFO 1 (**LFO 1**), and **Manual**, when the **Shape Amount** control itself modifies the wave shape. The three sources are additive: all may be used simultaneously.

All three oscillators have further parameters available for adjustment via the **Osc** Menu.

LFO 1 & LFO 2:

The two LFOs have identical sets of controls.

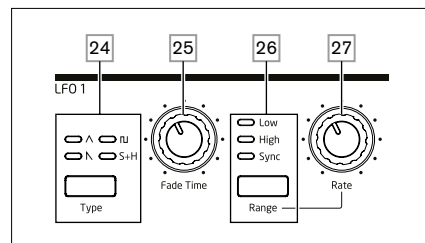

The outputs of either LFO may be used to modulate numerous other synth parameters. Summit's LFOs are all per-voice; that is, the modulating effect of the LFO waveform is applied independently to each of the eight voices making up the output of each oscillator.

24 **Type** - steps through the available waveforms: triangle, sawtooth, square, sample and hold. The associated LEDs give a visual indication of the LFO speed and waveform.

25 **Fade Time** - sets the timing of the LFO's action: it is possible to "ramp" the LFO up or down or to delay its effect. The options are set in the LFO menu.

26 **Range** - selects **High** or **Low**; the third option is **Sync**, which synchronises the LFO frequency to the internal arp clock or to an external MIDI clock if one is present.

27 **Rate** - sets LFO frequency.

Both LFOs have further parameters available for adjustment via the LFO Menu: these are described in detail later in the User Guide.

GLOBAL LFO 3 & 4:

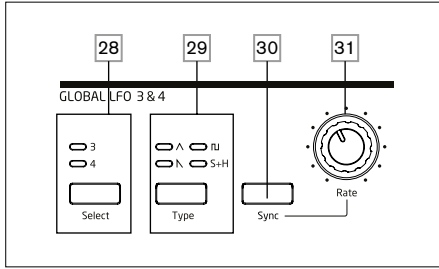

- 28 Select** – assigns the controls in this area to either LFO 3 or LFO 4.
- 29 Type** – steps through the available waveforms; as **24** above.
- 30 Rate** – sets LFO frequency.
- 31 Sync** – Pressing **Sync** synchronises the LFO frequency to the internal arp clock or to an external MIDI clock if one is present.

Both LFOs have further parameters available for adjustment via the **LFO Menu**: these are described in detail later in the User Guide.

FM:

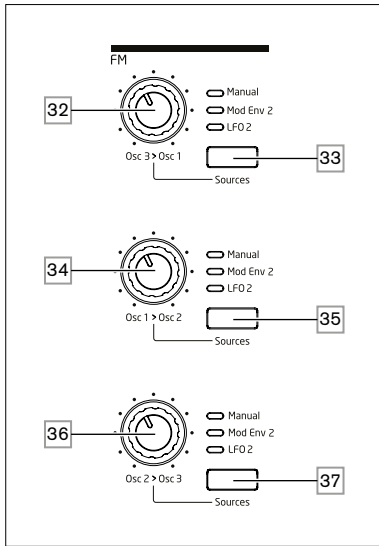

- 32 Osc 3 > Osc 1** – controls the depth of frequency modulation applied to Oscillator 1's pitch by Oscillator 3.
- 33 Source** – assigns the **Osc 3 > Osc 1** modulation depth control **32** to one of three sources. The options are: modulation by Envelope 2 (Mod Env 2), modulation by LFO 2 (**LFO 2**), and **Manual**, when the **Osc 3 > Osc 1** control itself sets the modulation depth. The three options are additive: all may be used simultaneously with the modulation depth for each source being set independently.
- 34 Osc 1 > Osc 2** - controls the depth of frequency modulation applied to Oscillator 2's pitch by Oscillator 1
- 35 Source** – performs the corresponding function as **Source** button **33** for the **Osc 1 > Osc 2** control **34**.
- 36 Osc 2 > Osc 3** - controls the depth of frequency modulation applied to Oscillator 3's pitch by Oscillator 2.
- 37 Source** – performs the corresponding function as **Source** button **33** for the **Osc 2 > Osc 3** control **36**.

Summit has further FM (Frequency Modulation) options, which may be configured through the menu system: these are described in detail later in the User Guide.

MIXER:

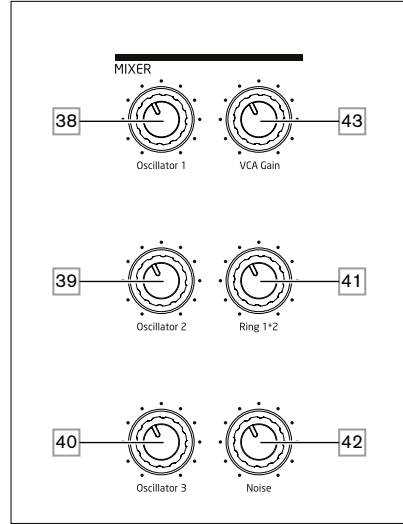

- 38 Osc 1** – controls the volume of Oscillator 1.
- 39 Osc 2** – controls the volume of Oscillator 2.
- 40 Osc 3** – controls the volume of Oscillator 3.
- 41 Ring 1*2** – controls the Ring Modulator output level: the inputs to the Ring Modulator are Osc 1 and Osc 2.
- 42 Noise** – controls the volume of the white noise generator.
- 43 VCA Gain** – this effectively controls the mixer output level: it adjusts the analogue gain applied to the summed signals. See page 21.

AMP ENVELOPE, MOD ENVELOPES:

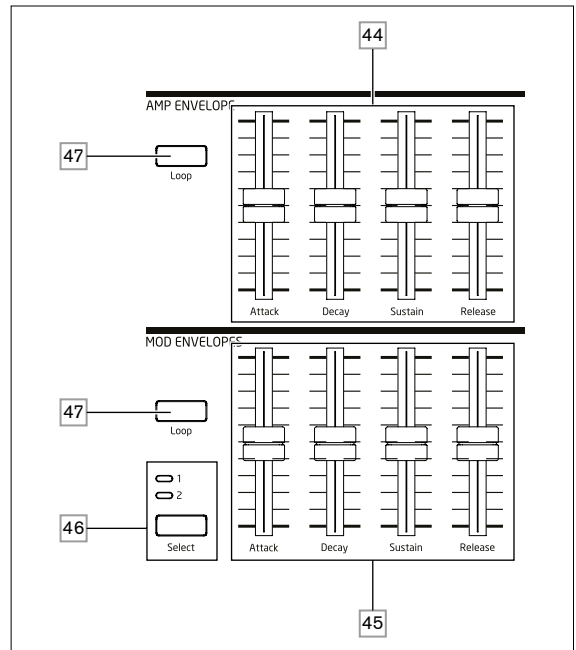

- 44 Amp Envelope controls** – a set of four 45 mm sliders adjusting the standard ADSR parameters (Attack, Decay, Sustain and Release) of the amplitude envelope.
- 45 Mod Envelope controls** – an identical set of sliders, adjusting the parameters of the two modulation envelopes (see **46**] below).
- 46 Select** – Summit generates two independent Mod Envelopes; this button selects which of these (**Mod 1** or **Mod 2**) the Mod Envelope sliders **45** control.
- 47 Loop** – enables the envelope's looping feature. This causes the AHD phases of the envelope to be retriggered a number of times, the number being defined by the **REPEATS** parameter in the **Env** menu.

All three envelopes have further parameters available for adjustment via the **Env Menu**; these are described in detail later in the User Guide. They include additional Delay and Hold envelope phases.

VOICE:

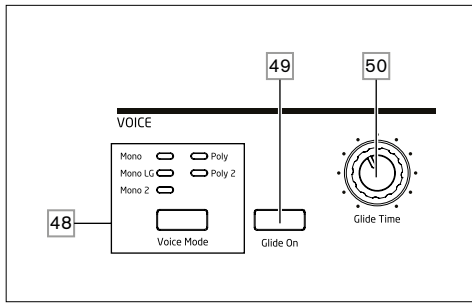

- 48 **Voice Mode** – selects one of five voice modes, three monophonic and two polyphonic
- 49 **Glide On** – enables/disables the Glide function.
- 50 **Glide Time** – sets the portamento glide time.

ARP:

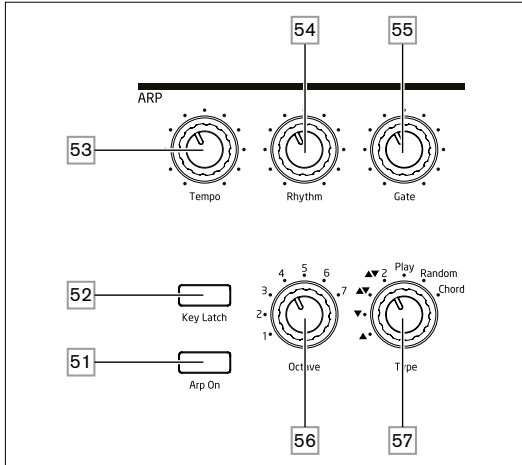

- 51 **Arp On** – turns the Arpeggiator on and off.
- 52 **Key Latch** – if Key Latch is selected while holding keys down, Summit will play the held notes continuously until it is deselected. This can be used to automatically maintain an arp sequence, but Key Latch can be used independently of the Arpeggiator to hold played notes for any length of time.
- 53 **Tempo** – sets the speed of the arp pattern.
- 54 **Rhythm** – selects one of 33 different patterns based on the notes played.
- 55 **Gate** – sets the duration of the notes played by the Arpeggiator.
- 56 **Octave** – sets the number of octaves over which the arp pattern extends; increasing the octave range increases the pattern length.
- 57 **Type** – further variations of the arp pattern are possible by varying Type. This allows you to choose the direction and/or order of the notes making up the pattern, such as up or down, random or chord formation.

The Arpeggiator has further parameters available for adjustment via the **Arp** Menu; these include settings such as clock source, sync rate and swing. These are described in detail later in the User Guide. Most of the panel controls are duplicated in the **Arp/Clock** menu.

FILTER:

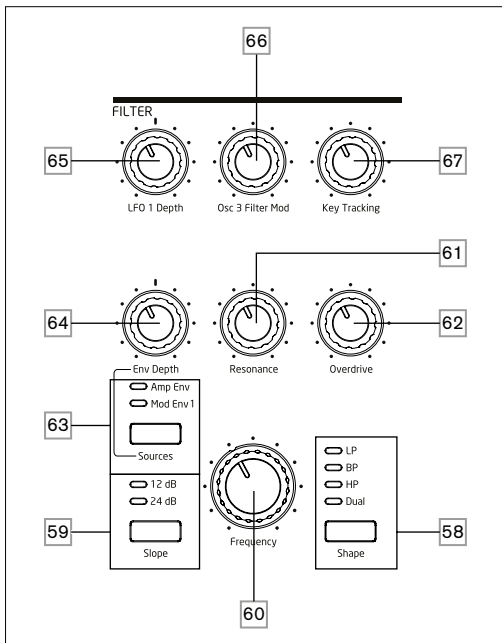

- 58 **Shape** – steps through the three basic types of filter: low-pass (**LP**), band-pass (**BP**) or high-pass (**HP**); selecting **Dual** opens a menu page (**Voice Menu Page 4**), where nine more options, based on series or parallel combinations of two filter types operating simultaneously may be selected.
- 59 **Slope** – sets the slope of the filter to either **12dB** or **24dB** per octave.
- 60 **Frequency** – large rotary knob controlling the filter's cut-off frequency (LP or HP), or its centre frequency (BP).
- 61 **Resonance** – adds resonance (an increased response at the filter frequency) to the filter characteristic.
- 62 **Overdrive** – adds a degree of pre-filter distortion to the mixer output.
- 63 **Source** – assigns the **Env Depth** control (64) to one of two sources which can modulate the filter frequency. The options are modulation by the amplitude envelope (**Amp Env**) or one of the mod envelopes (**Mod Env 1**). The two sources are additive: and may be used simultaneously.
- 64 **Env Depth** – controls the amount by which the filter frequency is modified by the envelope currently selected by **Source** (63). The two sources may have different values of depth. **Env Depth** is a centre-zero control and thus both positive and negative variations may be imposed on the filter frequency by each modulating source.
- 65 **LFO 1 depth** – controls the amount by which the filter frequency is modified by LFO 1. **LFO 1 Depth** is a centre-zero control and thus the filter frequency can be made to vary both positively and negatively.
- 66 **Osc 3 Filter Mod** – allows the filter frequency to be modulated directly by Oscillator 3.
- 67 **Key Tracking** – controls the amount by which the keyboard position of the note being played varies the filter frequency between 0 and 100%.

EFFECTS:

The Effects section for each of Summit's two Parts comprises three different DSP-based processors producing time-domain effects, plus an analogue distortion generator.

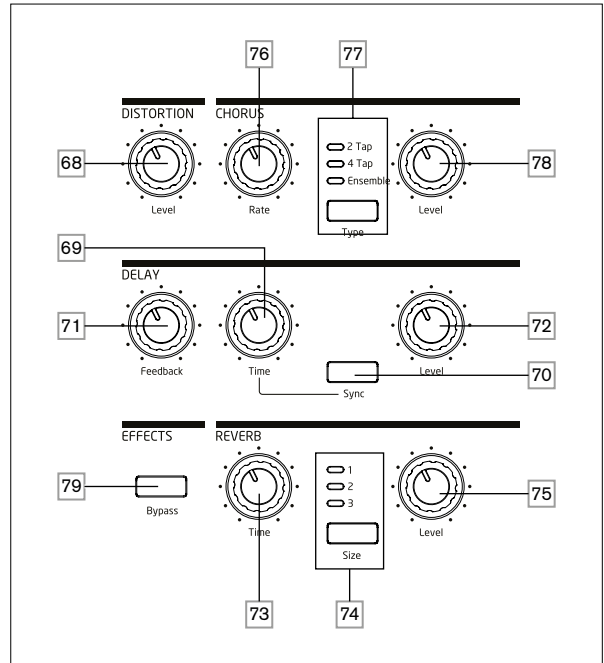

- 68 **DISTORTION: Level** – controls the amount of analogue distortion applied to the sum of all active voices for each Part.
- 69 **DELAY: Time** – sets the timing of the delayed signal (echo) added to the original. Maximum delay is approx. 1.4 seconds.
- 70 **DELAY: Sync** – selecting **Sync** allows the delay time to be synchronised to the internal clock or an incoming MIDI clock.
- 71 **DELAY: Feedback** – allows the delayed signal to be fed back to the input of the delay processor, creating multiple echoes.
- 72 **DELAY: Level** – controls the volume of the delayed signal.
- 73 **REVERB: Time** – adjusts reverberation decay time. (The maximum time is longer than anything you'll ever likely to need!)
- 74 **REVERB: Size** – emulates spaces of three different sizes: **3** is the largest.
- 75 **REVERB: Level** – controls the "amount" of reverberation.
- 76 **CHORUS: Rate** – adjusts the rate of chorus modulation.
- 77 **CHORUS: Type** – lets you select one of three different chorus algorithms.
- 78 **CHORUS: Level** – controls the degree of chorus effect.
- 79 **EFFECTS: Bypass** – the three time-domain effects (delay, reverb and chorus) may be switched in or out with this button. **Bypass** does not affect analogue distortion.

The Delay, Reverb and Chorus effects have further parameters available for adjustment via the **FX** Menu; these are described in detail later in the User Guide. Summit also has a dedicated four-slot FX Modulation Matrix with its own menu: this allows a wide range of FX parameters to be modulated by various synth sources.

ANIMATE:

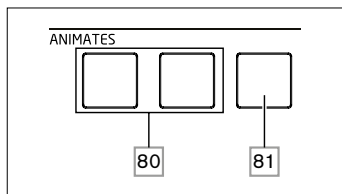

80 ANIMATES 1 and 2 – add an “instant” effect to the sound currently being generated by activating additional, pre-programmed modulation and effects routings that have been set up in the modulation matrix. These buttons are great in live performance: most of Summit’s factory Patches include Animate functions.

81 Hold – pressing **Hold** will “lock” the Animate function in an “On” state. You can either press **Hold** before pressing **ANIMATE**, or vice-versa. Pressing **ANIMATE** a second time releases both the Animate and Hold functions.

PERFORMANCE CONTROLS:

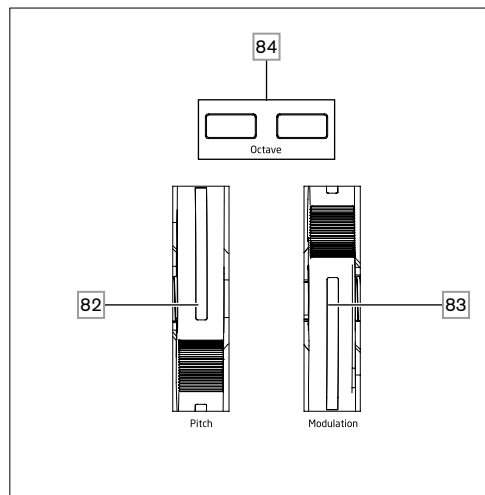

82 Soft rubber **Pitch** wheel with a positive return to the centre position. The default range is +/- one octave, but the Bend Range parameter in the Oscillator Menu allows a range of up to +/- two octaves for each oscillator independently.

83 Soft rubber **Modulation** wheel, the specific effect of which will vary with Patch. It may also be assigned as a Modulation Matrix source, to modify one or more parameters.

Note that the Pitch and Modulation wheels have internal illumination, colour-coded to follow the current A/B **MULTIPART** selection [12].

84 Octave + and Octave - buttons – shift the keyboard up or down by an octave with each press: the maximum range is +/-3 octaves. The illumination of the buttons increases with the degree of shift; both buttons are dark when no octave shift is in effect.

Rear Panel

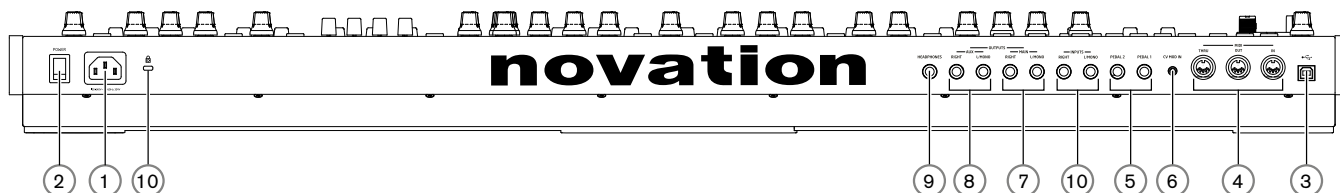

- ① IEC mains inlet – connect the supplied AC cable here.
- ② **POWER** – mains on/off switch.
- ③ standard Type ‘B’ USB 2.0 port. Connect to a Type A USB port on a computer using the supplied cable. Note that the USB port only carries MIDI data, not audio. You can use the USB port to send MIDI data to your computer from the keyboard or the top panel controls (rotary controls and faders).
- ④ **MIDI IN, OUT and THRU** – standard 5-pin DIN MIDI sockets for connecting Summit to a keyboard or other MIDI-equipped hardware.
- ⑤ **PEDAL 1** and **PEDAL 2** – two 3-pole (TRS) ¼” jack sockets for connection of switch (e.g., sustain) and/or expression pedals. The sockets detect switch pedal polarity automatically. Expression pedals are also detected automatically and can be routed directly as sources available to the Modulation Matrix. Switch pedal functions are configured in the **Settings** menu.
- ⑥ **CV MOD IN** – 3.5 mm jack socket for connecting an external Control Voltage source in the range of +/-5 V. This permits other analogue instruments (equipped with a compatible CV output) to modulate Summit’s sounds.
- ⑦ **MAIN OUTPUTS** – two ¼” 3-pole (TRS) jack sockets carrying Summit’s main output signal. Use both **L/MONO** and **RIGHT** for full stereo: if **RIGHT** is unconnected, a mono (L+R) sum is available at **L/MONO**. Outputs are pseudo-balanced.
- ⑧ **AUX OUTPUTS** – Summit is equipped with a second stereo output; Parts A and B can be independently assigned to either output, which is a powerful feature when using Multi Patches. It is also possible to assign the (wet) outputs of the FX section for either Part A and B to the main or auxiliary outputs. The mono/stereo options of the **AUX OUTPUTS** are identical to those of the **MAIN OUTPUTS**.
- ⑨ **HEADPHONES** – 3-pole (TRS) ¼” jack socket for stereo headphones. Phones volume is adjusted by the **Master Volume** control **1**.
- ⑩ **INPUTS** – two ¼” 3-pole (TRS) jack sockets for applying signals to Summit’s FX processors from external sources. A menu option (**Voice** Menu Page 3) allows a choice of inserting the external signal into the processing chain either pre or post the filter section. Use both **L/MONO** and **RIGHT** for full stereo (post-filter only): if **RIGHT** is unconnected, the signal will be treated as a mono input.
- ⑪ Kensington Security Slot – to secure your synth.

GETTING STARTED

Summit may, of course, be used simply as a standalone synthesiser. However, there are many more possibilities, and how you choose to integrate it into your existing synth/recording setup will be determined by the other equipment you have and your own imagination!

Below are three examples illustrating how Summit could form part of a synth setup. We've used Novation or Focusrite products throughout (we would, wouldn't we?), but of course you can use whatever equipment you have in your system provided it's functionally equivalent, of course.

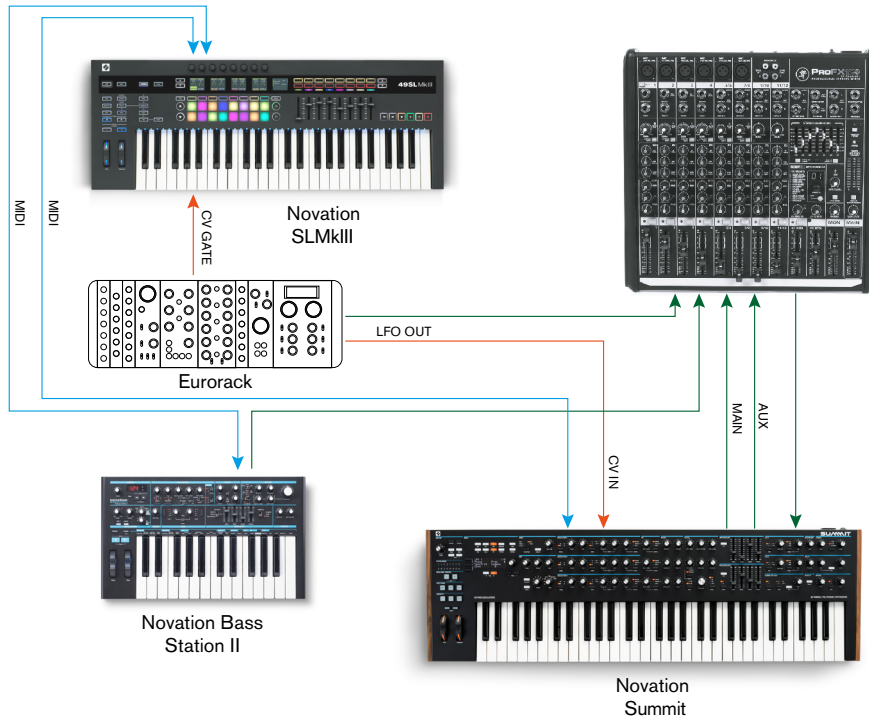

This setup does not use a DAW, and thus would be appropriate for live performance rather than recording. Here you could use a MIDI controller - the Novation SLMkIII - to trigger sounds in both Summit and another synth such as a Novation Bass Station II via MIDI, and in a Eurorack via CV+GATE. An external modular LFO in the Eurorack could modulate one or more parameters in Summit via its CV IN connection. Both audio outputs of Summit, plus those of Bass Station II and the Eurorack are all sent to the external mixer. You could also use Summit's FX section in a send-and-return loop from the mixer to add delay or reverb, etc.

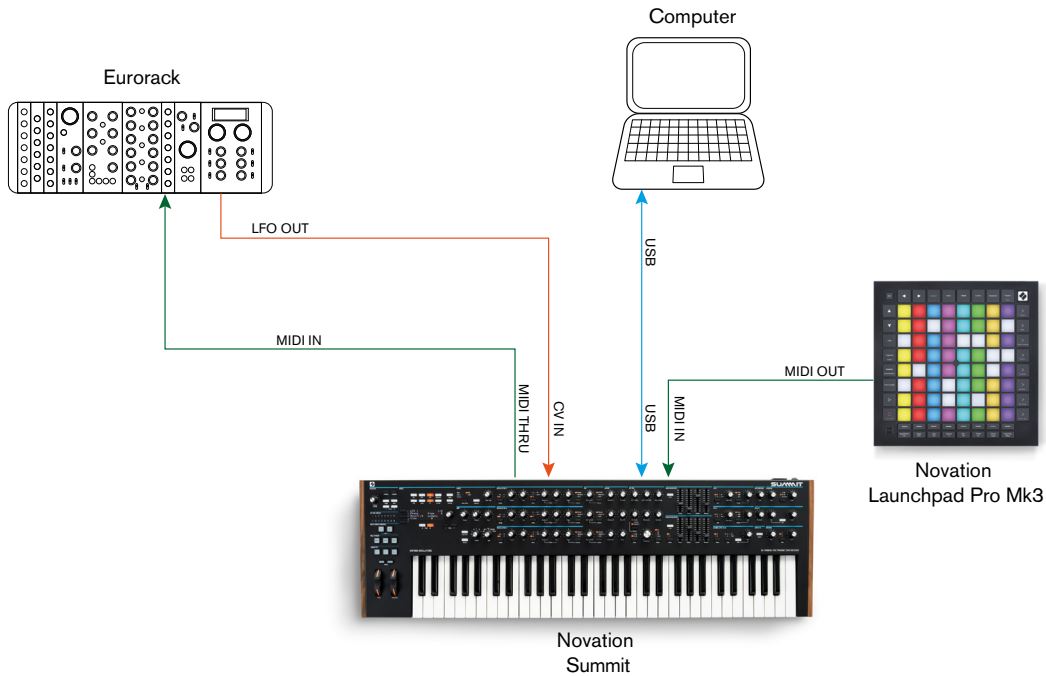

In the second example, a Launchpad Pro in stand-alone mode is connected via MIDI to Summit. This would permit Summit to be triggered by the Launchpad Pro, taking advantage of its polyphonic aftertouch capability. The MIDI data could also be routed through to the Eurorack, which again is providing an LFO output to Summit's CV input. Note that audio signals have been omitted from the diagram to aid clarity. The computer is connected to Summit via USB.

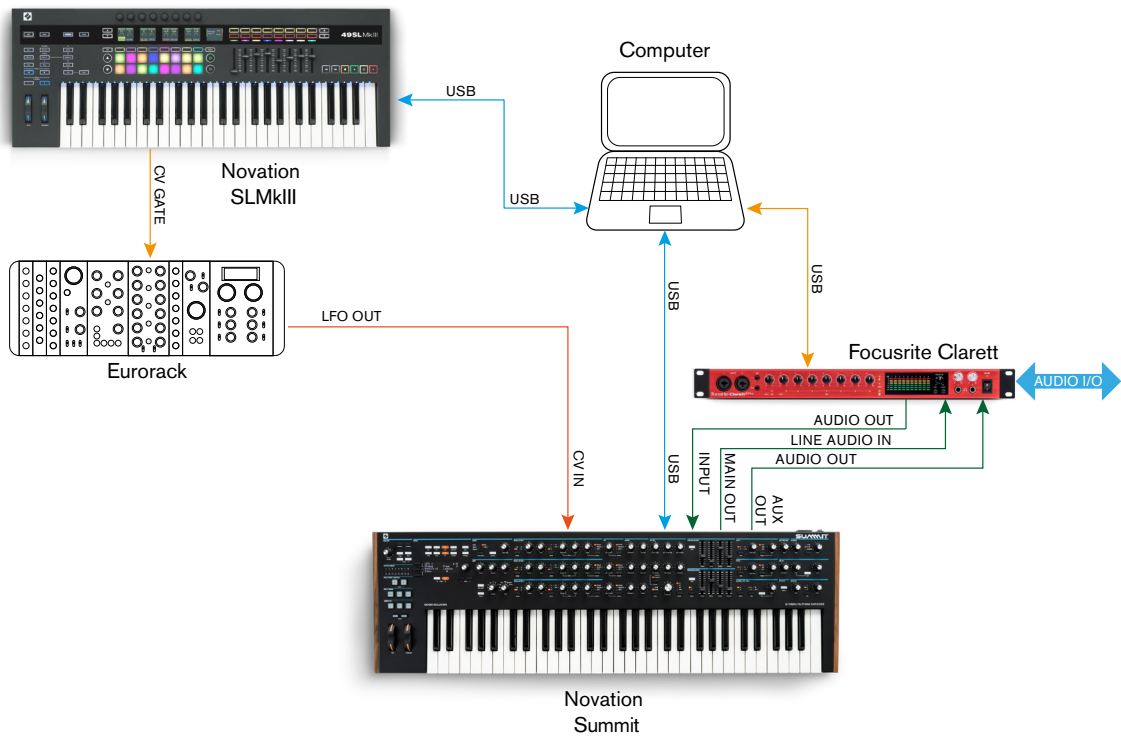

In this example, the computer is the primary item. All the audio is summed in a Focusrite Clarett audio interface and sent to the computer's DAW. The Clarett also enables other live instruments to be recorded in the DAW at the same time. As in Example 1, one of Summit's two FX sections can be used to treat an external signal in a loop from a Line In and a Line Out of the Clarett. The USB connection from the Clarett to the computer is to allow Clarett configuration with Focusrite Control software.

The simplest and quickest way of finding out what Summit can do is to connect the rear panel main outputs (7) – in either mono or stereo – to the input of a power amplifier, audio mixer, powered speaker or other means of monitoring the output.

If using Summit with other sound modules, connect **MIDI THRU** (4) to the next sound module's **MIDI IN**, and daisy-chain further modules in the usual way. By default, Summit transmits MIDI data on Channel 1: note that data for Part A and Part B are simultaneously transmitted separately on Channels 2 and 3 respectively. MIDI transmit/receive differs between Single Patch and Multi Patch modes: please see the table on page 46 for more details.

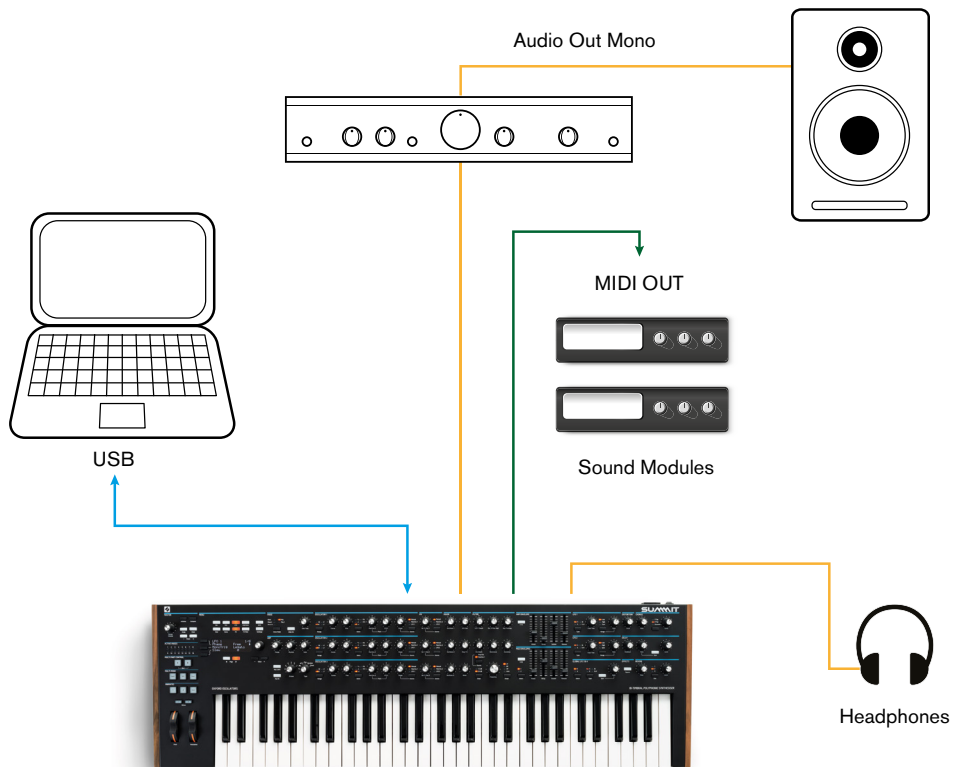

With the amplifier or mixer off or muted, connect the AC mains to Summit (1). Turn the synth on (2): after completing its boot sequence, Summit will load Single Patch 000*, and the LCD display will confirm this:

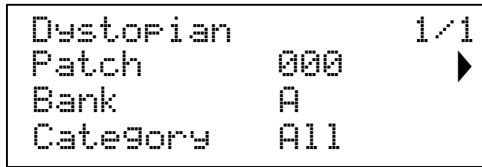

"Dystopian" is the name of the factory Single Patch in Bank A, memory location 000.

Turn on the mixer/amplifier/powered speakers, and turn up the **Master Volume** control (1) until you have a healthy sound level from the speaker when you play.

*This refers to the first time Summit is powered "out of the box". To save a new startup patch:

1. Go to the patch you want use as your startup patch
2. Press the Settings button to open the settings page.
3. Press the Save button.

The patch you were on before pressing the Settings button will now be your startup patch.

Using headphones

Instead of a speaker and/or an audio mixer, you may wish to use a pair of headphones. These may be plugged into the rear panel headphone output socket (9). The main outputs are still active when headphones are plugged in. The **Master Volume** control (1) also adjusts headphone level. By default, the headphone output follows the main output, which – again by default – carries both Parts A and B of a Multi Patch. You can change what you hear in the headphones on Page A of the **Settings** menu.

NOTE: Summit's headphone amplifier is capable of outputting a high signal level; please take care when setting the volume.

Menu Navigation

Although most of the key parameters affecting the nature of the sound Summit generates are accessible through dedicated, "per-function" rotary controls and switches, many further parameters and synth settings can be modified using the OLED display and its associated controls. The menu system has been designed so all parameters and settings can be accessed on a single menu "level" – there are no multi-level submenus to navigate.

Summit's menu system has been designed to be as simple and consistent as possible. The buttons (9) above the display, plus **Settings** and the two **Patch** buttons (4) and (5), select one of eleven menus. All menus except Single Patch have multiple pages: use the **Page** (left and right) buttons to scroll through the pages in sequence.

On each page, Row 1 is a "title" row and stays fixed. Rows 2, 3 and 4 each display a parameter for modification; some pages do not present data in all rows. Use the three buttons to the left of the display to select the row to edit: the active row is indicated by a (right arrow) symbol. The parameter value may be adjusted either by the rotary control or the **Value +/-** buttons.

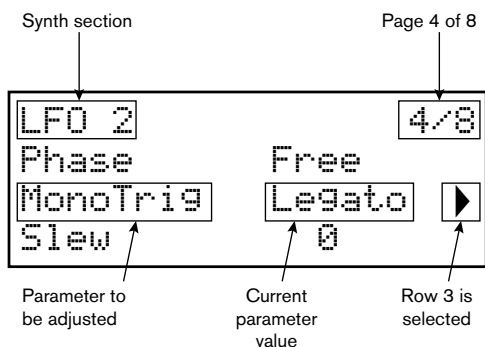

Bi-timbral synthesis

Summit can be effectively two synthesisers in one. Each control on the panel and each menu function can affect the relevant parameter in either or both, depending on the mode in use.

When a Single Patch is in use, the two synthesisers operate "in tandem": they are both operational but do exactly the same thing. When you move a control on the panel or adjust a parameter in a menu, you are making the same adjustment to both synths, by the same amount. Each synth has 8 voices, so you have 16 voices available in all. The **MULTIPART CONTROL** and **MULTIMODE** buttons (12) to (15) will be unlit.

When a Multi Patch is in use, the two synths operate independently. The Multi Patch will consist of two separate Single Patches, one – Part A – generated by one synth, the other – Part B – by the other. The ability to combine two different sounds gives you a greatly enlarged sound palette to work with, as every parameter in each Part may be adjusted independently, if wished.

When a Multi Patch is selected (or created), the **MULTIPART CONTROL** and **MULTIMODE** buttons become available, and their colour reflects Summit's operational mode:

ACTIVE PARTS	COLOURS
Part A	Blue
Part B	Orange
Parts A and B	White

With Part A selected in **MULTIPART CONTROL**, Summit's controls will affect only the synth generating Part A: similarly, with Part B selected, the controls affect the Part B synth. You can press buttons **A** and **B** together to invoke the third control state – **Both**. Now the control panel – knobs, buttons, sliders and menus - will affect both synths at the same time.

You can choose how to play Multi Patches with the three **MULTIMODE** buttons, though a factory Multi Patch will default to the Mode that the sound designer had in mind when they developed the Patch.

- In **Layer** Mode, you will hear parts A and B mixed together (initially 1:1, but the actual mix can be adjusted in the menus), and you can play the Multi Patch over the whole extent of the keyboard.
- In **Split** Mode, Part A is assigned to the lower part of the keyboard and Part B to the upper. The "split point" is, by default, at middle C (C3). You can move the split point anywhere else on the keyboard by holding down the **Split** button and then pressing the key denoting the new split point, or by changing the **SPLITPOINT** parameter for the Multi Patch on Page 3 of the **MULTI SETTINGS** Menu. Note that the chosen split point is specific to each Patch: different Patches may have different split points.
- In **Dual** Mode, what you hear follows the selected **MULTIMODE CONTROL** button, so you can play Part A or Part B alone over the whole extent of the keyboard. If you press **A** and **B** together to invoke the **Both** state, you will hear both Parts A and B together: this is exactly the same configuration as selecting **Layer** Mode: in this case, the control panel and menus will affect both Parts simultaneously.

Loading Patches

Summit has 1,024 memory locations for Patches:

- 512 for Single Patches
- 512 for Multi Patches.



Because each Multi Patch is made up of two Patches - which can be played independently if you wish - you actually have 1,536 individual Patches at your disposal!

The two blocks of 512 have the same arrangement: each consists of four Banks of 128; the banks are designated A to D. The memory is pre-loaded with 768 factory Patches: these have been especially created for Summit and we hope they will inspire you and be of use to you in your compositions.



A full list of factory Patches and sound designer credits can be found at the end of this manual, see page 50

There are 384 each of Single Patches and Multi Patches. These occupy Banks A, B and C in both cases; both Banks D are provided as convenient memory locations for storing your own Patches, although you can store your own Patches in any memory location if you don't mind overwriting a factory Patch (they can easily be restored using Novation Components). Each Bank D memory location is pre-loaded with the same default "initial" Patch: for Single Patches this is named **Init Patch**, and for Multi Patches it is named **Init Multi**.

An initial Patch will always be the starting point for creating new sounds "from scratch".

A Patch is loaded by simply selecting its number with the rotary control or **Value +/-** buttons (10), or the **Patch +/-** buttons (6), if row 2 is currently selected on the OLED. It is immediately active.

Single Patches

When a Single Patch is loaded, the Patch Information page is displayed:

```
Dystopian          1/1
Patch              000
Bank              A
Category          All
```

The top row of the page displays the Patch name; below this are the Patch number and Bank name (A, B, C or D).

The bottom row, Category, indicates which "type" the Patch is. The default setting is All, but if you select one of the twelve other categories available (plus two additional "User" categories), then stepping through the Patches - either with the rotary control [10] or the **Patch +/-** buttons [6] - will only offer Patches of that category; this is useful for speeding up Patch selection.

Multi Patches

When a Multi Patch is loaded, the first of four Patch Information pages is displayed:

```
Gas Valves        1/4
MultiPatch        005
MultiBank         A
```

As with Single Patches, the Patch name, number and Bank are displayed. Note that the prefix Multi is appended to the Patch and Bank labels, to help distinguish them from the Single Patch information.

Press **Page** ▶ to display Page 2:

```
FlintTinder      2/4
Patch            000
Bank            A
Category        All
```

Part A

```
Boo Creeps      2/4
Patch            000
Bank            A
Category        All
```

Part B

This page gives you details of the two Single Patches that have been combined to create the Multi Patch. Press the **MULTIPART CONTROL** buttons **A** or **B** to see the Patch for each Part. Note that they are all shown as occupying Bank A, Patch 000. This is to allow you to select an alternative single Patch (or Init Patch) to modify the overall sound of the Multi Patch. The Category field operates in the same way as with Single Patches.

Press **Page** ▶ to display Page 3:

```
MULTI SETTINGS   3/4
Level A          60
Level B          127
SplitPoint      F 3
```

This page allows you to set the relative volume of Parts A and B of the Multi Patch. **Level A** and **Level B** are operative regardless of whether Parts A and B are routed to the same output (the default setting), or separately to the Main and AUX Outputs. This alternative routing may be made on Page A of the **Settings** menu (see page 42).

In **Split Mode**, Part A is played by the lower part of the keyboard and Part B by the upper. The split point can be anywhere on the keyboard and you will find its position varies between Multi Patches. For Init Patch, the "split point" is at middle C (C3): in the Patch example shown above, the Patch designer decided to place it at F3. You can change the split point by selecting Row 4 and choosing another note, from C-2 to G8. This range is greater than the size of the keyboard because it allows for octave shifting of the keyboard, or of MIDI Note data being received by Summit from an external source.

If you only want to move the split point within the physical keyboard range, hold down the **Split** button [14] and then press the key denoting the new split point.

Press **Page** ▶ to display Page 4:

```
MULTI SETTINGS   4/4
Octave A         +0
Octave B         +0
```

The **Octave A** and **Octave B** parameters let you pitch-shift the two Parts of the Multi Patch independently of each other, by one or two octaves, up or down.

Comparing Patches

The **Compare** button [3] lets you hear the Patch you loaded in its "factory" state, ignoring any changes or tweaks you've been making. Hold the button down to hear the original Patch: when you release it, you'll be back to your modified version. Note that you can't select **Compare** while holding any keys down. This is a useful feature to use when you're about to save a new Patch into a memory location that might already contain a Patch you want to retain - you can press **Compare** during the Save process to check what's in the intended memory location.

Quick Initialisation

You can press **Initialise** [2] at any time to load a copy of Summit's default initial Patch. The Patch loaded will be **Init Patch**. If you are in Multi Patch mode, **Init Patch** will be loaded for either Part A or Part B, depending which Part was the last to be selected.

Loading **Init Patch** does not overwrite the previous Patch, though you will lose any modifications you made to the previous Patch if you haven't already saved it.





Note that when you change Patch, you lose the current synth settings. If the current settings were a modified version of a stored Patch, these modifications will be lost. Therefore it is always advisable to save your settings before loading a new patch. See "Saving Patches" Below.

Saving Patches

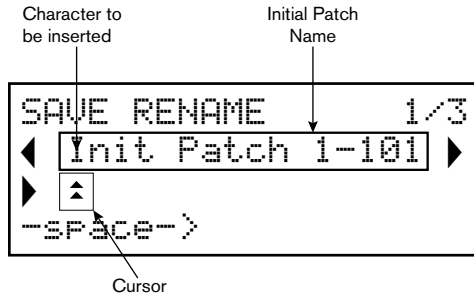
Single Patches can be saved to any of the reserved 512 memory locations; similarly, Multi Patches can be saved to any of their 512 locations. However, if you save your Patch to any location in Banks A, B or C in either case, you will overwrite one of the factory presets. To save a Patch press the **Save** button . The OLED display changes as shown below:



You can now give the Patch you want to save a name. The existing name is displayed initially; use the Row 2 button () to move the cursor to the character position to be changed and then use the rotary parameter control  to select the new letter. Repeat this process one character at a time. Upper case, lower case, numbers, punctuation marks and space characters are all available in sequence from the rotary control. Use the Row 4 button to insert a space instead of a character. When you have entered the new name, press **Page** () to move to Page 2, where you decide which memory location the modified Patch will be saved in.

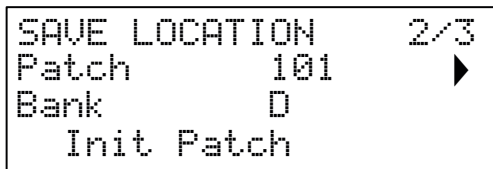

Now you can enter the memory location by Bank and number. Note that the name of the Patch currently in the memory location you select is displayed on Row 4, to remind you what is already stored there in case it's something you don't want to overwrite. Press **Page** () again to select Page 3, and you can (if you wish) assign your Patch to one of the several pre-determined categories.

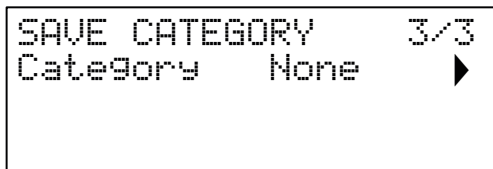

When you've done this, press **Save** again, and the display will confirm the Patch is saved.



You may save a modified Patch to the same location, if you are happy for the earlier version to be overwritten. This can easily be achieved by pressing **Save** four times in succession.



Summit Factory Patches can be downloaded using Novation Components if they have been accidentally overwritten. See page 12

Basic Operation – sound modification

Once you have loaded a Patch you like the sound of, you can modify the sound in many different ways using the synth controls. Each area of the control panel is dealt with in greater depth later in the manual, but a few fundamental points should be noted first.

The OLED display

The OLED display will show the last menu page selected until a rotary control or slider is moved on the control panel. This instantaneously changes the display to show the control being moved: it will also show the new parameter value alongside the parameter value that was saved for the currently loaded Patch:

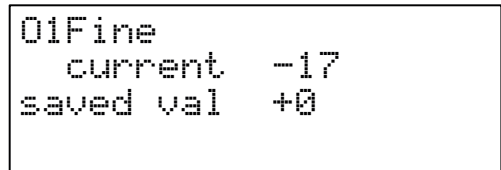

Many rotary controls have a parameter range of 0 to +127. Others, e.g., the Filter's **Env Depth** control or the Oscillators' **Mod Env 2** controls, are effectively "centre-zero", and have a parameter range of either -64 to +63 or -128 to +127.

The display reverts to the previous menu page a short time (user-definable) after the control is released. If no control is touched for 10 minutes, the display turns off, but will resume immediately when a control or menu button is selected.

Exceptions to the above are the **Master Volume** rotary control, the **more** setting of the three Oscillator **Wave** buttons and the **Dual** setting of the Filter **Shape** button. When you adjust the **Master Volume** control it does not alter the OLED display in any way, but selecting an Oscillator **Wave to more** will change the display to page 3, 5 or 7 of the **Osc** menu (the page number depending on the oscillator being adjusted), as these pages include the **waveMore** parameter for wavetable selection. Similarly, setting Filter **Shape to Dual** changes the display to page 4 of the **Voice** menu, where the **FltShpMore** and **FltFreqSep** parameters, which are used for multiple filter configurations, are available.

Parameter adjustment

As with traditional analogue synths, most of the primary sound modification controls on Summit are dedicated, physical rotary controls or switches, providing instant access to the most commonly needed sound parameters.

Many more parameters are available for adjustment in most of the synth sections via the menu system; these tend to be parameters you wouldn't need immediate access to during live performance. Those in the **Osc**, **Env**, **LFO**, **Arp/Clock**, **Voice** and **FX** menus all affect the relevant sections of sound generation and treatment directly, while the **Mod** and **FX Mod** menus let you interconnect different synth sections with the Modulation Matrix or the independent FX Modulation Matrix, which is dedicated to the control of FX parameters.

The Filter knob

Adjusting the frequency of the synth's filters is probably the most commonly-used method of sound modification in live performance. For this reason, Filter Frequency has a large rotary control  immediately above the keyboard. Experiment with different types of patch to hear how changing the filter frequency alters the characteristic of different types of sound. Also listen to the different effect of the three basic filter types, then try selecting configurations of dual filters by setting **Shape to dual**.

Keyboard controls

Summit's keyboard is fitted with a standard pair of synthesiser control wheels, **Pitch** and **Mod** (Modulation). **Pitch** is spring-loaded and will return to its centre position. The range of control of pitch is independently adjustable for each oscillator (with the **BendRange** parameter - see page 26) in semitone increments up to +/-2 octaves; the default setting for the Initial Patch is +/-1 octave, but many Patches will have different bend ranges.

The **Mod** wheel's function varies with the patch loaded; it is generally used to add expression or various elements to a sound. A common use is to add vibrato to a sound.

It is possible to assign the **Mod** wheel to alter various parameters making up the sound - or a combination of parameters simultaneously. This topic is discussed in more detail elsewhere in the manual. See page 46.

We have also equipped the keyboard with a pair of Octave Shift buttons [84]. These effectively shift the entire keyboard up or down an octave at a time with each press, up to maximum of three octaves. When in use, an **Octave** button will illuminate white at one of three different brightness levels to indicate Octave Shift is active: the brightness increasing with the degree of shift applied.

By default, the C roughly in the middle of the keyboard (just below the Oscillator **Shape** controls) is Middle C (relative to A = 440 Hz).

The Arpeggiator

Summit includes a powerful arpeggiator (the 'Arp'), which allows arpeggios of greatly varying complexity and rhythm to be played and manipulated in real-time. The Arpeggiator is enabled by pressing the **Arp On** button [51].

In its most basic configuration, when a single key is pressed the note will be retriggered by the arpeggiator, at a rate determined by the **Tempo** control or the **ClockRate** parameter on Page 1 of the **Arp** menu. If you play a chord, the arpeggiator identifies its notes and plays them individually in sequence at the same rate (this is known as an arpeggio pattern or 'arp sequence'); therefore if you play a C major triad, the arpeggiated notes will be the C, E and G making up the chord.

The arp tempo can also be synced to an incoming MIDI clock, so you can easily lock arp patterns to sequencers, drum machines or other sound generators.

Adjusting the **Gate** [55], **Type** [57], **Rhythm** [54] and **Octave** [56] controls will alter the rhythm of the pattern (the way the sequence is played and the note range) in a variety of ways. Most of these parameters and several others, can also be adjusted from Page 2 of the **Arp** menu. See page 33 for full details.

MIDI control

Summit has a high degree of MIDI implementation, and almost every control and synth parameter is able to transmit MIDI data to external equipment, and similarly, the synth may be controlled in almost every respect by incoming MIDI data from a DAW, sequencer or master control keyboard. Moreover, synth data for each of the two bi-timbral parts may be transmitted and received on different MIDI channels, permitting an enormous range of external MIDI interfacing possibilities.

The **Settings** menu has three pages devoted to MIDI configuration, and provides numerous options for enabling various aspects of MIDI control. Apart from per-Part MIDI Channel setting, these include Arpeggio MIDI Out, Aftertouch, CC/NRPN transmit/receive and Program/Bank Change transmit/receive. Please see page 46 for full details.

The factory default is for all MIDI transmit/receive options to be On, and MIDI Channel 1 is set as the active channel for global synth data, Channel 2 for Part A data and Channel 3 for Part B data. See the table at page 40 for more details.

The Animate Buttons

Each of the two **ANIMATE** buttons [80] may be programmed to provide instant modification to the synth's sound, which persists for as long as the button is pressed. This is a great way of adding sound effects "on the fly" in live performance.

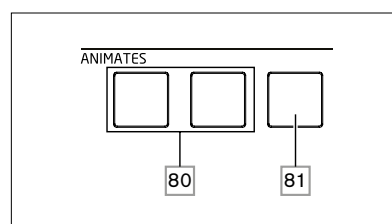

Many of Summit's factory Patches include programming for the **ANIMATE** buttons. When an Animate function is available, the button is illuminated. The **ANIMATE** buttons are programmed using the Modulation Matrix, and appear in the Source lists in the **Mod** and **FX Mod** menus. Each button may be assigned as a modulation source for any of the Destinations available in either (or both) the Mod Matrix and FX Mod Matrix. See page 38 and page 39 for more details.

SYNTHESIS TUTORIAL

This section covers the general principles of electronic sound generation and processing in more detail, including references to Summit's facilities where relevant. It is recommended that this chapter is read carefully if analogue sound synthesis is an unfamiliar subject. Users familiar with this subject can skip this section and move on to the next.

To gain an understanding of how a synthesiser generates sound it is helpful to have an appreciation of the components that make up a sound, both musical and non-musical.

The only way a sound may be detected is by air vibrating the eardrum in a regular, periodic manner. The brain interprets these vibrations (very accurately) into one of an infinite number of different types of sound.

Remarkably, any sound may be described in terms of three properties, and all sounds always have them. They are:

- Pitch
- Timbre
- Volume

What makes one sound different from another is the relative magnitudes of the three properties as initially present in the sound, and how the properties change over the duration of the sound.

With a musical synthesiser, we deliberately set out to have precise control over these three properties and, in particular, how they can be changed during the "lifetime" of the sound. The properties are often given different names, e.g., Volume may be referred to as Amplitude, Loudness or Level, Pitch as Frequency and sometimes Timbre as Tone.

Pitch

As stated, sound is perceived by air vibrating the eardrum. The pitch of the sound is determined by how fast the vibrations are. For an adult human, the slowest vibration perceived as sound is about twenty times a second, which the brain interprets as a low bass sound; the fastest is many thousands of times a second, which the brain interprets as a high-pitched sound.

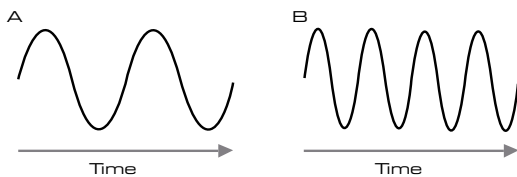

If the number of peaks in the two waveforms (vibrations) are counted, there are exactly twice as many peaks in Wave B as in Wave A. (Wave B is actually an octave higher in pitch than Wave A.) The number of vibrations in a given period determines the pitch of a sound. This is the reason pitch is sometimes referred to as frequency. It is the number of waveform peaks counted during a given period of time which defines the pitch, or frequency.

Timbre

Musical sounds consist of several different, related pitches occurring simultaneously. The lowest is usually referred to as the 'fundamental' pitch and corresponds to the perceived note of the sound. Other pitches making up the sound which are related to the fundamental in simple mathematical ratios are called harmonics. The relative loudness of each harmonic as compared to the loudness of the fundamental determines the overall tone or 'timbre' of the sound.

Consider two instruments such as a harpsichord and a piano playing the same note on the keyboard and at equal volume. Despite having the same volume and pitch, the instruments still sound distinctly different. This is because the different note-making mechanisms of the two instruments generate different sets of harmonics; the harmonics present in a piano sound are different to those found in a harpsichord sound.

Volume

Volume, which is often referred to as the amplitude or loudness of the sound, is determined by how large the vibrations are. Very simply, listening to a piano from a metre away would sound louder than if it were fifty metres away.



Having shown just three elements may define any sound, these elements now have to be realised in a musical synthesiser. It is logical that different sections of the synthesiser 'synthesize' (or create) each of these different elements.

One section of the synthesiser, the **Oscillators**, generate raw waveform signals which define the pitch of the sound along with its raw harmonic content (tone). These signals are then mixed together in a section called the **Mixer**, and the resulting mixture is then fed into a section called the **Filter**. This makes further alterations to the tone of the sound, by removing (filtering) or enhancing certain harmonics. Lastly, the filtered signal is fed into the **Amplifier**, which determines the final volume of the sound.

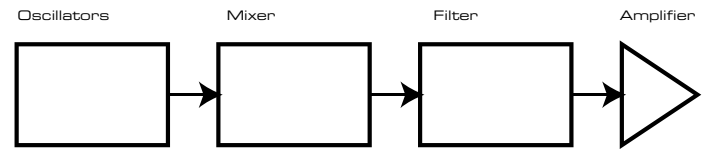

Additional synthesiser sections - **LFOs** and **Envelopes** - provide further ways of altering the pitch, tone and volume of a sound by interacting with the **Oscillators**, **Filter** and **Amplifier**, providing changes in the character of the sound which can evolve over time. Because **LFOs** and **Envelopes** only purpose is to control (modulate) the other synthesiser sections, they are commonly known as 'modulators'.

These various synthesiser sections will now be covered in more detail.

The Oscillators and Mixer

The Oscillator section is the heart of the synthesiser. It generates an electronic wave (which creates the vibrations when eventually fed to a loudspeaker). This waveform is produced at a controllable musical pitch, initially determined by the note played on the keyboard or contained in a received MIDI note message. The distinctive tone or timbre of the waveform is actually determined by the waveform's shape.

Many years ago, pioneers of musical synthesis discovered just a few distinctive waveforms contained many of the most useful harmonics for making musical sounds. The names of these waves reflect their actual shape when viewed on an instrument called an oscilloscope, and they are: Sine waves, Square waves, Sawtooth waves, Triangle waves and Noise. Each of Summit's Oscillator sections can generate all these waveforms, and can generate non-traditional synth waveforms as well. (Note that Noise is actually generated independently and mixed in with the other waveforms in the Mixer section.)

Each waveform (except Noise) has a specific set of musically-related harmonics which can be manipulated by further sections of the synthesiser.

The diagrams below show how these waveforms look on an oscilloscope, and illustrate the relative levels of their harmonics. Remember, it is the relative levels of the various harmonics present in a waveform which determine the tonal character of the final sound.

Sine Waves

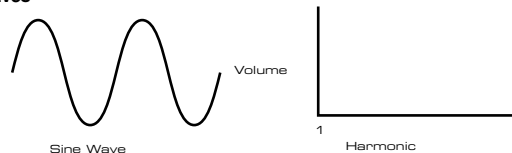

These possess just one harmonic. A sine waveform produces the "purest" sound because it only has this single pitch (frequency).

Triangle Waves

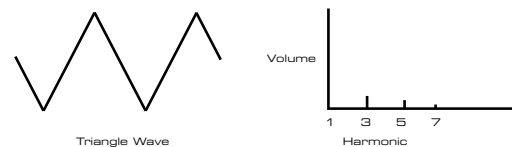

These contain only odd harmonics. The volume of each decreases as the square of its position in the harmonic series. For example, the 5th harmonic has a volume 1/25th of the volume of the fundamental.

Sawtooth Waves

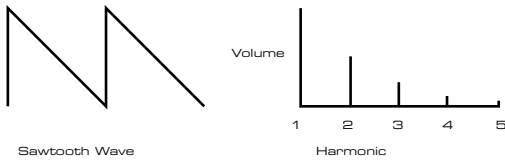

Sawtooth waves are rich in harmonics, and contain both even and odd harmonics of the fundamental frequency. The volume of each is inversely proportional to its position in the harmonic series.

Square / Pulse Waves

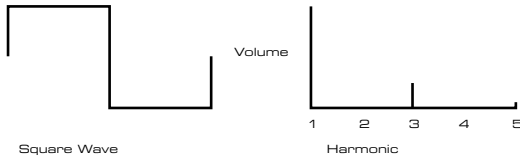

Square/Pulse waves contain only odd harmonics, which are at the same volume as the odd harmonics in a sawtooth wave.

The square waveform spends an equal amount of time in its 'high' state as in its 'low' state. This ratio is known as the 'duty cycle'. A square wave always has a duty cycle of 50% which means it is 'high' for half the cycle and 'low' for the other half. Summit lets you adjust the duty cycle of the basic square waveform (via the **Shape** controls) to produce a waveform which is more 'rectangular' in shape. These are often known as Pulse waveforms. As the waveform becomes more and more rectangular, more even harmonics are introduced and the waveform changes its character, becoming more 'nasal' sounding.

The width of the pulse waveform (the 'Pulse Width') can be altered dynamically by a modulator, which results in the harmonic content of the waveform constantly changing. This can give the waveform a 'fat' quality when the pulse width is altered at a moderate rate.

A pulse waveform sounds the same whether the duty cycle is – for example - 40% or 60%, since the waveform is just "inverted" and the harmonic content is exactly the same.

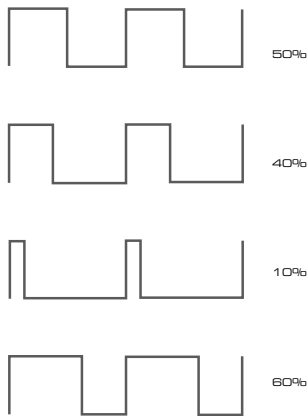

Noise

Noise is a random signal, and does not have a fundamental frequency (and therefore has no pitch property). Noise contains all frequencies, and all are at the same volume. Because it possesses no pitch, noise is often useful for creating sound effects and percussion type sounds.



Ring Modulation

A Ring Modulator is a sound generator that takes signals from two oscillators and effectively "multiplies" them together. Summit's Ring Modulator uses Oscillator 1 and Oscillator 2 as inputs. The resulting output depends on the various frequencies and harmonic content present in each of the two oscillator signals, and will consist of a series of sum and difference frequencies as well as the frequencies present in the original signals.

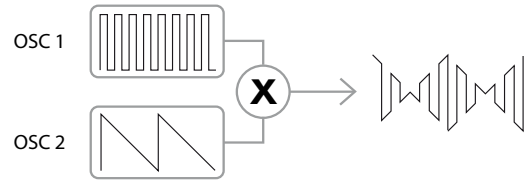

Frequency Modulation (FM)

Another method of combining the signals from two sources is Frequency Modulation, or FM. In this technique, the frequency of one oscillator – sometimes referred to as the "carrier" - is dynamically varied about its nominal "centre" value by an amount corresponding to the instantaneous amplitude of the signal from the second oscillator. Summit has a set of controls on the panel dedicated to adding FM effects.

The precise sonic result will depend on the wave shapes of each oscillator, their relative pitch, and the maximum amplitude of the modulating signal: on Summit this latter parameter may be controlled manually, and may be further varied by both LFO and Envelope.

The result of frequency modulation is the generation of a wide range of additional harmonics (in fact, theoretically infinite), both above and below the pitch of the oscillator being modulated. In FM language, these harmonics are often referred to as sidebands. The number of "significant" sidebands is proportional to the amplitude of the modulating signal and inversely proportional to the frequency difference between the carrier and the modulator. If the modulator is already rich in harmonics, e.g., something other than a simple sine wave, each harmonic creates its own set of sidebands, further enriching the spectral content of the result.

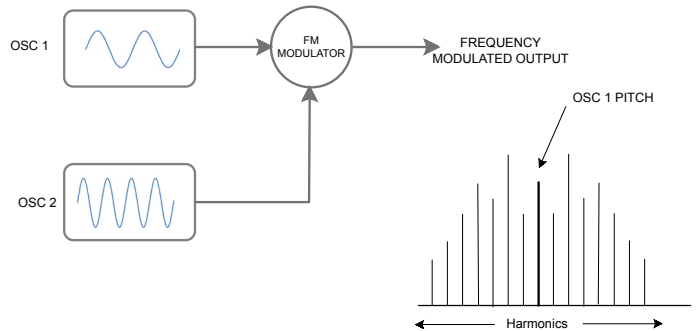

The Mixer

To extend the range of sounds you can produce, typical analogue synthesisers have more than one Oscillator (Summit has three for Part A and three for Part B). By using multiple Oscillators to create a sound, it is possible to achieve interesting harmonic mixes. It is also possible to slightly detune individual Oscillators against each other, which creates a warm, 'fat' sound.

Summit's Mixer allows you to create a sound consisting of the waveforms of Oscillators 1, 2 and 3, a Noise source and the Ring Modulator output, all mixed together as needed.

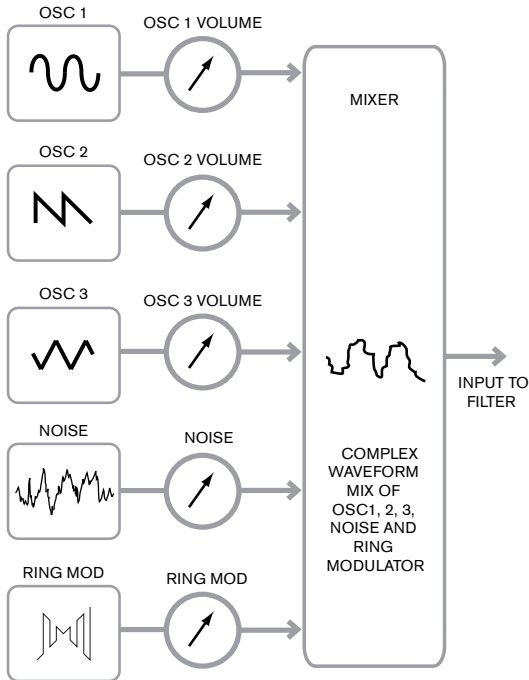

The Filter

Summit is a *subtractive* synthesiser. *Subtractive* implies part of the sound is subtracted somewhere in the synthesis process.

The Oscillators provide the raw waveforms with plenty of harmonic content and the Filter section subtracts some of the harmonics in a controlled manner.

There are three basic filter types, all of which are available in Summit: low-pass, band-pass and high-pass. The type of filter most commonly used on synthesisers is low-pass. In a low-pass filter, a "cut-off frequency" is chosen and any frequencies below this are passed, while frequencies above are filtered out, or removed.

The setting of the **Filter Frequency** parameter dictates the point above which frequencies are removed. This process of removing harmonics from the waveforms has the effect of changing the sound's character or timbre. When the Frequency parameter is at maximum, the filter is completely "open" and no frequencies are removed from the raw Oscillator waveforms.

In practice, there is a gradual (rather than a sudden) reduction in the volume of the harmonics above the cut-off point of a low-pass filter. How rapidly these harmonics reduce in volume as frequency increases above the cut-off point is determined by the filter's **Slope** parameter. The slope is measured in 'volume units per octave'. Since volume is measured in decibels, this slope is usually quoted as so many decibels per octave (dB/oct). The higher the number, the greater the rejection of harmonics above the cut-off point, and the more pronounced the filtering effect. Each of Summit's filter sections has a 12 dB/oct slope, but two of the same type can be cascaded (placed in series) to produce a slope of 24 dB/oct. Summit also allows two different types of filter to be cascaded, or even to be placed "in parallel", so the mixer output is treated by both.

A further important parameter of the filter is Resonance. Frequencies at the cut-off point may be increased in volume by advancing the filter's **Resonance** control. This is useful for emphasising certain harmonics of the sound.

As Resonance is increased, a whistling-like quality will be introduced to the sound passing through the filter. When set to very high levels, Resonance actually causes the filter to self-oscillate whenever a signal is being passed through it. The resulting whistling tone being produced is actually a pure sine wave, the pitch of which depends on the setting of the **Frequency** control (the filter's cut-off point). This resonance-produced sine wave can actually be used for some sounds as an additional sound source if wished.

The diagram below shows the response of a typical low pass filter. Frequencies above the cut-off point are reduced in volume.

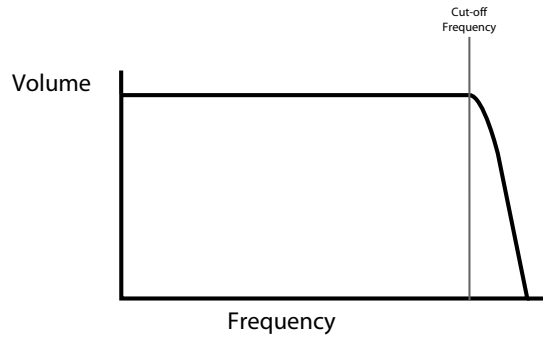

When resonance is added, the frequencies around the cut off point are boosted in volume.

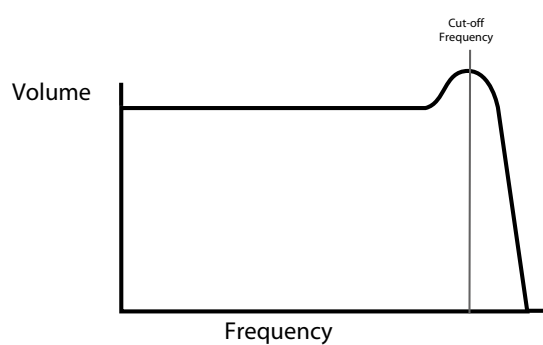

In addition to the traditional low-pass filter type, there are also high-pass and band-pass types. On Summit, the filter type is selected with the **Shape** switch 58 .

A high-pass filter is similar to a low-pass filter, but works in the "opposite sense", so frequencies below the cut-off point which are removed. Frequencies above the cut-off point are passed. When the Filter **Frequency** parameter is set to minimum, the filter is completely open and no frequencies are removed from the raw Oscillator waveforms.

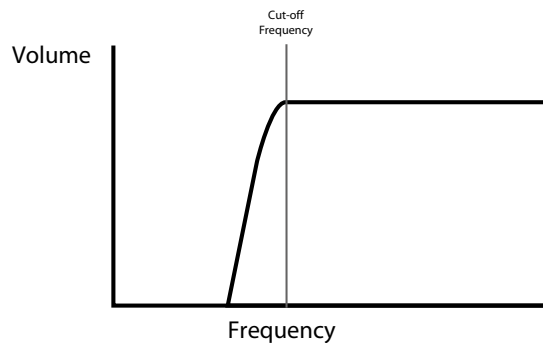

With a band-pass filter, just a narrow band of frequencies centred around the cut-off point is passed. Frequencies above and below the band are removed. It is not possible to fully open this type of filter and allow all frequencies to pass.

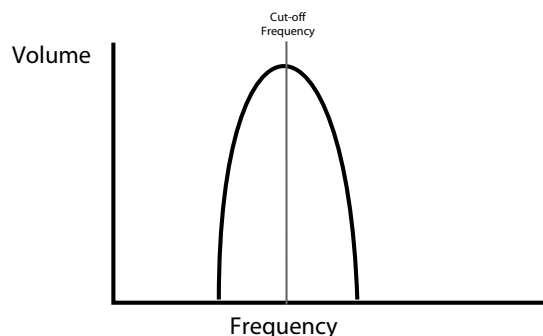

More complex relationships between volume and frequency can be obtained by using simple filters of the types described above in combination. Summit allows you to "cascade" two filters of different types, creating a "series" combination. Such a combination will generally result in more frequencies being removed than with a single filter section, as both filters are subtractive. However, interesting results can arise if the two filters have different cut-off frequencies.

For example, if a low-pass filter is followed by a high-pass filter, the low-pass filter will pass only very high frequencies to the high-pass filter, which will remove some of them, leaving a narrow band of frequencies "between" the cut-off frequencies of both filters. The width of this band depends on the difference between, or "separation of" the two cut-off frequencies.

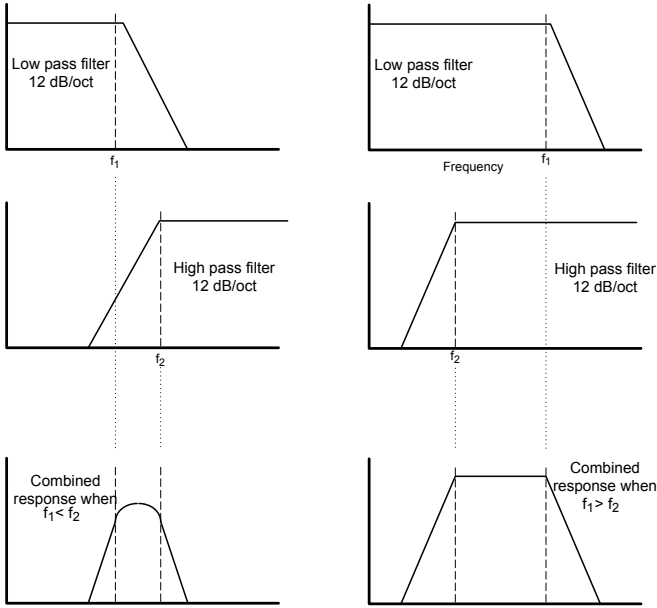
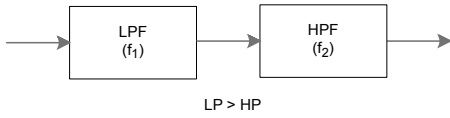

Combining the same filters in parallel produces quite a different result, as the responses of the two sections are effectively summed together. Low frequencies will be passed by the low-pass filter and high frequencies by the high-pass filter, resulting in a dip or a hump in the response in the area between the two cut-off frequencies.

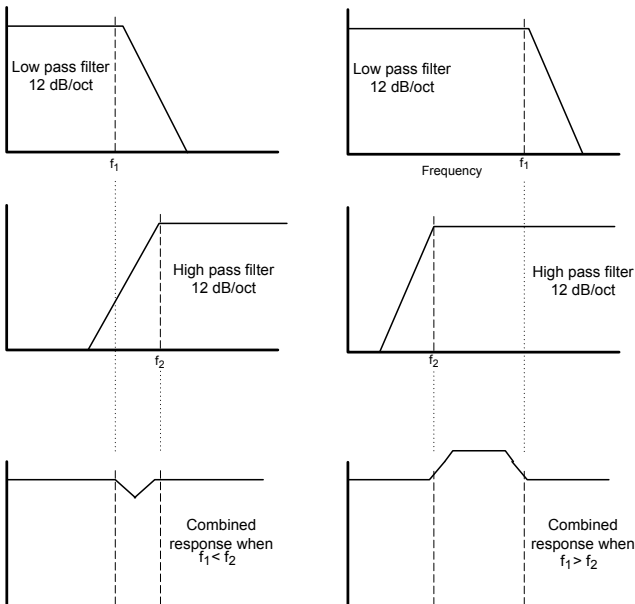
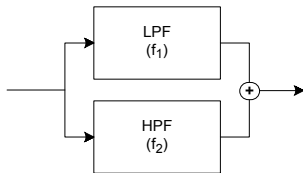

Envelopes And Amplifier

In earlier paragraphs, the synthesis of the pitch and the timbre of a sound was described. The next part of the Synthesis Tutorial describes how the volume of the sound is controlled. The volume of a note created by a musical instrument often varies greatly over the duration of the note, according to the type of instrument.

For example, a note played on an organ quickly reaches full volume when a key is pressed. It stays at full volume until the key is released, then the volume level falls instantly to zero.

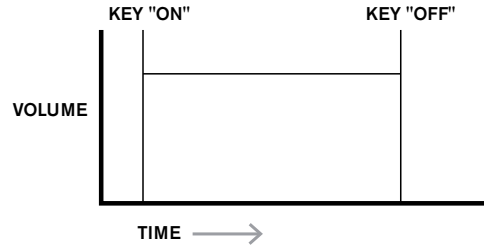

A piano note quickly attains full volume after a key is pressed, but gradually falls in volume to zero after several seconds, even if the key is held.

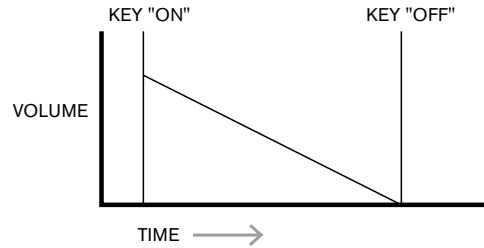

A string section emulation only attains full volume gradually when a key is pressed. It remains at full volume while the key is held down, but once the key is released, the volume falls to zero fairly slowly.

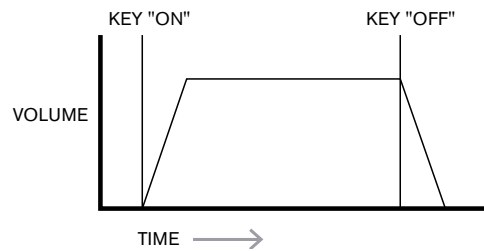

In an analogue synthesiser, changes to a sound's character which occur over the duration of a note are controlled by sections called Envelope Generators. One of these (**Amp Env**) is always related to the Amplifier, which controls the note's amplitude - i.e., the volume of the sound - when the note is played. In Summit, each envelope generator has five main parameters, which determine the shape of the envelope; these are referred to as the AHDSR parameters, or the envelope "phases".

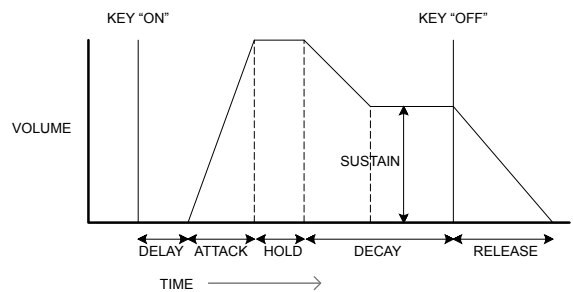

Attack Time

Adjusts the time it takes after a key is pressed for the volume to climb from zero to full volume. It can be used to create a sound with a slow fade-in.

Hold Time

This parameter is not found on many synthesisers, but is available in Summit. It determines for how long the note's volume remains at its maximum level following the Attack Time, before commencing the volume drop set by the Decay Time.

Decay Time

Adjusts the time it takes for the volume to fall from its initial full volume to the level set by the Sustain control while a key is held down.

Sustain Level

This is unlike the other Envelope controls as it sets a level rather than a period of time. It sets the volume level that the envelope remains at while the key is held down, after the Decay Time has expired.

Release Time

Adjusts the time it takes for the volume to fall from the Sustain level to zero once the key is released. It can be used to create sounds that have a "fade-out" quality.

Delay Time

You will notice the diagram also includes a further, initial phase, Delay. This is how long it takes for the Attack Time – and hence the entire AHDSR sequence - to commence after the key is struck. This is another envelope phase which is not generally found on other synthesisers, but is available in Summit. The addition of a Delay Time leads us to rename the envelope sequence DAHDSR for completeness (though many users will continue to refer to it by the more traditional term ADSR).

Most modern synthesisers can generate multiple envelopes. Summit has three Envelope Generators: **Amp Env** has a dedicated set of hardware ADSR slider controls (Delay and Hold are controlled separately via the menu), and is always applied to the amplifier to shape the volume of each note played, as detailed above. The two Modulation Envelopes (**Mod Env 1** and **Mod Env 2**) share an identical set of controls, with an assignment switch selecting the envelope being controlled. Modulation envelopes can be used to dynamically alter other sections of the synthesiser during the lifetime of each note. Summit's **Mod Env** Generators can be used to modify the filter cut-off frequency, or the pulse width of the Oscillators' Square Wave outputs, for example.

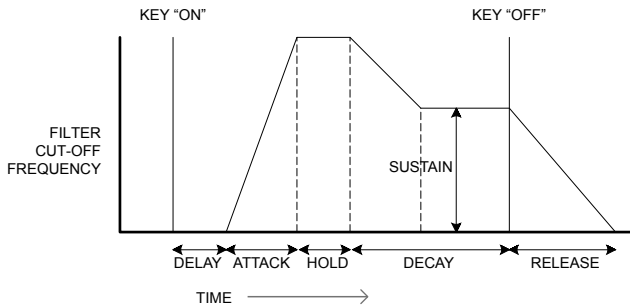

LFOs

Like the Envelope Generators, the LFO (Low Frequency Oscillator) section of a synthesiser is a Modulator. Instead of being a part of the sound synthesis itself, it is used to change (or modulate) other sections of the synthesiser. In Summit, for example, the LFOs can be used to alter Oscillator pitch, or Filter cutoff frequency, as well as many other parameters.

Most musical instruments produce sounds that vary over time both in volume and in pitch and timbre. Sometimes these variations can be quite subtle, but still contribute greatly towards characterising the final sound.

Whereas an Envelope is used to control a one-off modulation over the lifetime of a single note, LFOs modulate by using a repeating cyclic waveform or pattern. As discussed earlier, Oscillators produce a constant waveform, which can take the shape of a repeating sine wave, triangle wave etc. LFOs produce waveforms in a similar way, but normally at a frequency which is too low to produce a sound the human ear could perceive directly. As with an Envelope, the waveforms generated by the LFOs may be fed to other parts of the synthesiser to create the desired changes over time – or 'movements' - to the sound. Summit has four LFOs, two of which are completely independent, with their own full set of hardware controls. All the LFOs may be used to modulate different synthesiser sections and can run at different speeds.

Imagine this low frequency wave being applied to an Oscillator's pitch. The result is the pitch of the Oscillator slowly rises and falls above and below its original pitch. This would simulate, for example, a violinist moving a finger up and down the string of the instrument whilst it is being bowed. This subtle up and down movement of pitch is referred to as the 'Vibrato' effect.

A waveshape often used for an LFO is a Triangle wave.

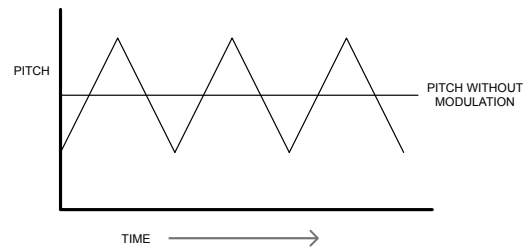

Alternatively, if the same LFO signal were to modulate the Filter cut-off frequency instead of the Oscillator pitch, a familiar wobbling effect known as 'wah-wah' would be the result.

Summary

A synthesiser can be broken down into five main sound generating or sound modifying (modulating) blocks:

1. Oscillators that generate waveforms at a various pitches.
2. A Mixer that mixes the outputs from the Oscillators together (and add Noise and other signals).
3. Filters that remove certain harmonics, changing the character or timbre of the sound.
4. An Amplifier controlled by an Envelope generator, which alters the volume of a sound over time when a note is played.
5. LFOs and Envelopes that can be used to modulate any of the above.

Much of the enjoyment to be had with a synthesiser is with experimenting with the factory preset sounds (Patches) and creating new ones. There is no substitute for 'hands on' experience. Experiments with adjusting Summit's various controls will eventually lead to a fuller understanding of how the various synth sections alter and help shape new sounds. Armed with the knowledge in this chapter, and an understanding of what is actually happening in the synth when tweaks to the knobs and switches are made, the process of creating new and exciting sounds will become easy. Have fun!

SUMMIT: SIMPLIFIED BLOCK DIAGRAM

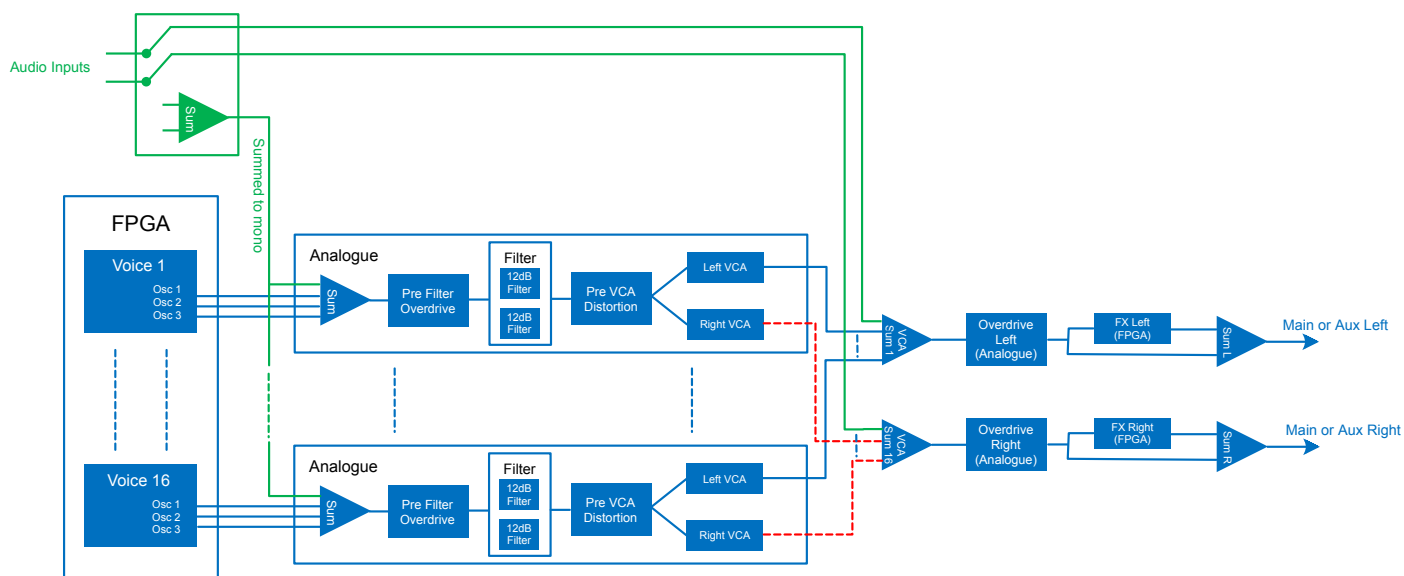

Summit's architecture essentially comprises two complete, identical, but entirely separate synthesisers with a single set of controls. Depending on the type of Patch in use – Single or Multi – the two synths either work in an identical manner, with each control affecting the same parameter in both synths simultaneously (Single Patches), or they work differently, to generate Parts A and B of a Multi Patch, with each control affecting its parameter in only one of the two synths at a time.

Each of Summit's two Parts uses eight separate voices, which are treated independently throughout the remaining signal chain. The voices are synthesised digitally in a Field Programmable Gate Array (FPGA) using Numerically Controlled Oscillators running at an extremely high clock rate, resulting in waveforms which are indistinguishable from those using traditional analogue synthesis.

Each voice is a mix of the outputs of the three oscillators; when you adjust one of the oscillator level controls **38**, **39** or **40** you are effectively adjusting the level of eight voices simultaneously. The subsequent elements in the signal processing chain are entirely in the analogue domain. Note that distortion can be added in several places – before the filter (**Overdrive 62**), after the filter (**FilterPostDrive** in the **Voice Menu**) and after final voice summation (**Distortion Level 68**). The sonic effect can be quite different in each case.

Note that the time-domain effects (FX) – chorus, delay and reverb – are digitally generated within the FPGA as well. The stereo effects send into the FX processing section is taken from post the main VCA, so all distortions added to the signals are processed by the FX. The FX return signal is added back to the same point in the signal path.

External inputs

Summit also has a pair of audio inputs (see **10** at page 9): these allow you to connect external audio sources – e.g., from other synth modules - and then use Summit's extensive processing capabilities to treat their sounds. The two ¼" jack sockets are intended for the left and right signals of a stereo pair, but you can connect a mono source to the LEFT input only if you wish.

Page 3 of the **Voice** menu enables these inputs and lets you choose whether the external signals connected are to be mixed with each of the 16 voices at the input of the analogue filter section, or to be added to the synth sound "post-VCA" at the output of the filter section. The first option – **PreFilter** in the menu – effectively adds the external signals to Summit's own internally generated sounds, and they will therefore undergo the same signal processing as the native synth sounds, including analogue Pre Filter Overdrive and Pre-VCA Distortion.

The second option – **PostFilter** in the menu – lets you route the external signals directly to Summit's FX section, where they can either be added to the native synth sounds, or have one of the FX sections allocated to them exclusively: this selection is made on Page C of the **Settings** menu. Because the outputs of the FX sections may be routed to either the main or auxiliary outputs, this allows you to add FX to external signals entirely independently of any synthesiser functions.

SUMMIT IN DETAIL

In this section of the manual, each section of the synthesiser is discussed in greater detail. The sections are arranged in order of "signal flow" – see the Block Diagram above. Within each section, the surface physical controls are described first, followed by a reference guide to the display menu relating to the section. In general, the menus offer "fine control" parameters to which access is less readily needed. The "initial value" given for each parameter is that for the factory Init Patch: these will differ when another Patch is loaded.

NOTE:

Because of Summit's bi-timbral architecture, the description of each section's controls and menu applies equally to both Parts of a Multi Patch. The descriptions can be taken as equally applicable to either Part A or Part B, though the adjustments will be made to only one Part at a time, unless **MULTIPART CONTROL** is set to **Both**.

We must emphasise that there is no substitute for experimentation. Adjusting controls and tweaking individual parameters while listening to different patches will tell you more about what each parameter does than this User Guide ever could. In particular, we would encourage you to experiment with the effect that varying a parameter has on different Patches – you will find there can be considerable differences between Patches, depending on how the sound is being generated.

Voices

Summit is a bi-timbral, 16-voice, polyphonic instrument. "Polyphonic" basically means you can play multiple notes on the keyboard, and every note you hold down will sound. "Bi-timbral" means Summit's Patches have two separate Parts, which may be adjusted as if they were one, or completely independently. When you select a Single Patch, Summit becomes a single synth with sixteen voices. With Multi Patches, you still have sixteen voices, but now eight are allocated to generating Part A and eight to Part B.

As you play, each note is assigned one or more 'voices', and as Summit supports eight voices per Part, you will often run out of fingers before you run out of voices! But this does depend on how many voices are assigned to each note – see the Unison parameter in the **Voice** Menu page 23). However, if you are controlling Summit from a MIDI sequencer or DAW, it is possible to run out: sequencers don't have the human constraint of a finite number of fingers. Although this is likely to happen infrequently, users may occasionally observe this phenomenon, which is termed 'voice stealing'.

The alternative to polyphonic voicing is mono. With mono voicing, only one note sounds at a time; pressing a second key while holding the first down will cancel the first and play the second – and so on. The last note played is always the only one you hear. All the early synths were mono, and if you are trying to emulate a 1970s analogue synth, you may wish to set the voicing to mono as the mode imposes a certain restriction on playing style that will add to authenticity.

Each of Summit's two synths may have its own polyphony mode: as you select different factory Multi Patches, you will find some create Part A using one mode and Part B using another. Other Patches use the same mode for both Parts.

Per-Part Selection of Summit's polyphony mode is made with the **Voice Mode** button [48]. Further voicing and Glide parameters are available for adjustment in the **Voice** menu (see opposite), which also includes settings related to some other synth functions.

As the names imply, three of the possible modes are mono and two are polyphonic.

1. **Mono** – this is standard monophonic mode; only one note sounds at a time, and the "last played" rule applies - if you play more than one key, only the last pressed will be heard. The same voice or voices are used for every note: this means each note played will re-trigger the voices even if the previous note is still sounding. When **Glide** is turned On, a portamento glide will always occur between successive notes.
2. **Mono 2** – this mode operates in the same way as Mono, except voices are assigned "in rotation" as each note is played. Unlike Mono or MonoLG, this has the effect (depending on playing speed) of allowing each note to complete its individual envelope. The main advantage of the Mono 2 voice mode is when using envelopes with an appreciable attack phase length: the envelope is always reset when a new key is pressed. This is not how analogue envelope generators work, but many digital envelope generators work on this principle.
3. **MonoLG** – LG stands for Legato Glide. This is an alternative mono mode, which differs from Mono in the way Glide and Pre-Glide work. In MonoLG mode, Glide and Pre-Glide only work if the keys are played in a legato style, i.e., with note overlap; playing notes separately produces no glide effect. As with Mono, the same voices are re-used for every note.
4. **Poly** – in polyphonic mode, up to 16 voices of a Single Patch can sound simultaneously: depending on how many voices are assigned in the Patch, this means you can play up to 16 notes simultaneously (you may not have enough fingers for this, but an external MIDI sequencer probably has!). If you play the same note repeatedly, each note will be assigned a different voice, and you will hear the individual envelopes of every note.
5. **Poly2** – in this alternative polyphonic mode, successively playing the same note(s) uses the same voices, the voices being re-triggered by new notes. This can change the behaviour of voice stealing. For example, in **Poly2** mode, when playing chord shapes with similar notes (e.g., Amin7 to Cmaj) the notes C, E and G will be played twice as well as the A and the B, i.e., a total of eight voices. If playing a melody in the other hand, one voice from the first chord will be stolen, which may be the lowest A. In Poly 2 mode, the C, E and G will only be played once, which will leave three voices free for playing a melody.

The effect of the different polyphony modes can be quite subtle, depending on the Patch in use and playing style, and we recommend you experiment!

Glide

Summit's Glide function makes notes played sequentially glide from one to the next, rather than immediately jumping from one pitch to another. It is enabled with the **Glide On** button [49]. The synth remembers the last note played per Voice and the glide – up or down - will start from that Voice's last triggered pitch even after the key has been released. The duration of the glide is set by the **Glide Time** control [50]: the maximum glide time available is approximately 5 seconds.

Glide is primarily intended for use in a mono Mode, where it is particularly effective. It can also be used in Poly modes, but its operation can be slightly unpredictable, because the glide will be from the previous note used by the voice now assigned to the note being played. This may be particularly evident with chords. Note the **Pre-Glide** parameter (on Page 2 of the **Voice** Menu) must be set to zero in order for Glide to be operative.

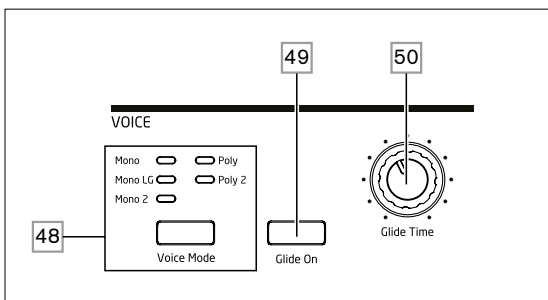

The Voice Menu

Press **Voice** [9] to open the Voice menu. This has four pages: Pages 1 and 2 contain voicing parameters, while Pages 3 and 4 contain various other synth parameters (these are described here for logical consistency).

Voice Menu Page 1:

VOICE		1/4
Unison	1	▶
UniDeTune	25	
UniSread	0	

Unison

Displayed as: Unison
Initial value: 1
Range of adjustment: 1, 2, 3, 4, 8

Unison can be used to "thicken" the sound by assigning additional voices (up to eight in total) for each note. Be aware the number of voices is finite and with multiple voices assigned, the polyphonic capability of the active Part may be reduced. With four voices per note, only two notes may be played together fully polyphonically, if further notes are played, "voice stealing" is implemented and the first note played will be cancelled. With Unison set to 8, Summit's currently selected Part becomes a multi-voice monophonic synth.



If the limitation on polyphony imposed by Unison Voices is restrictive and the oscillators are set to Sawtooth, a similar effect can be obtained by using the `SawDense` and `DenseDet` parameters in the Oscillator Menu. (In fact, some of the factory patches use this technique.) `SawDense` and `DenseDet` have no impact on the polyphony.

Voice DeTune

Displayed as: UniDeTune
Initial value: 25
Range of adjustment: 0 to 127

Unison Detune is only effective when `Unison` is set to something other than 1. The parameter determines how much each voice is detuned relative to the others; detuning is generally desirable as adding additional "identical" voices has much less effect.

Voice panning

Displayed as: UniSread
Initial value: 0
Range of adjustment: 0 to 127

`UniSread` gives you a method of controlling how the separate voices are positioned in the stereo image. With `UniSread` set to zero, all voices are centrally panned, effectively providing a mono image. As the value of `UniSread` is increased, multiple voices are panned increasingly left and right – odd-numbered voices to the left and even to the right.

Stereo image placement diagram for 4 voice unison with `UniSread` set mid way

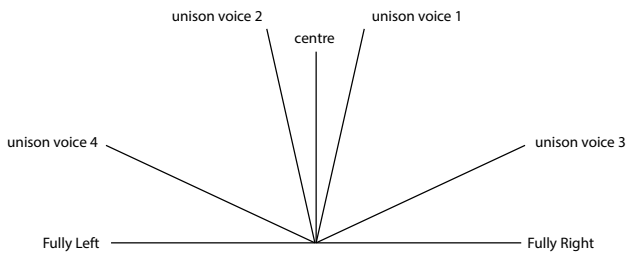

Stereo image placement diagram for 4 voice unison with `UniSread` increased

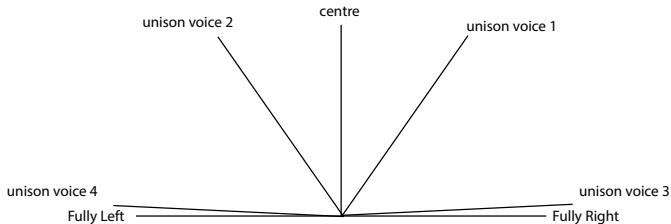

Note `UniSread` is still effective even with unison voices set to 1: in this case, a single note played is positioned centrally in the stereo image, while playing multiple notes results in left or right panning, depending whether the voice in use is odd- or even-numbered. When used like this, best results are obtained with moderate amounts of `UniSread`.

Voice Menu Page 2:

VOICE		2/4
PreGlide	+0	▶
PatchLevel	64	

Pre-Glide

Displayed as: PreGlide
Initial value: 0
Range of adjustment: -12 to +12

If set to a value other than zero, Pre-Glide takes priority over Glide, though it does use the setting of the `Glide Time` control [50] to determine its duration. Note that `Glide On` [49] must be selected for Pre-Glide to work. `PreGlide` is calibrated in semitones, and each note played will actually begin on a chromatically-related note up to an octave above (value = +12) or below (value = -12) the note corresponding to the key pressed, and glide towards the 'target' note, over a time set by the `Glide Time` control. This differs from `Glide` in that, e.g., two notes played in sequence will each have their own Pre-Glide, related to the notes played, and there will be no glide 'between' the notes.



Although the use of `Glide` is not recommended in Poly modes when playing more than one note at a time, this restriction does not apply to Pre-Glide, which can be very effective with full chords.

Patch Level

Displayed as: Patch Level
Initial value: 64
Range of adjustment: 0 to 127

This is an additional level trim control, whose setting is saved with the Patch. This allows you to set the overall volume of each Patch, so all the Patches in use are at the levels you want. With a value of 0, the Patch volume is halved; with a value of 127, it is doubled.

Voice Menu Page 3:

VOICE		3/4
FltPostDrv	0	▶
FltDiverge	0	
AudioInput	Off	

Post Filter Distortion

Displayed as: FltPostDrv
Initial value: 0
Range of adjustment: 0 to 127

This parameter controls how much pre-envelope distortion is added to the sound after the filter, but (crucially) before the amplifier. This distortion will thus remain constant when the amplifier is gradually opened and closed by the amplitude envelope, unlike that added by the Effects section `DISTORTION Level` control [68], which follows the amplifier in the signal chain. Note also this distortion is distinct from the distortion which results from adjusting the `Overdrive` control [62] in the filter section: it is applied only to the frequencies passed by the filters, whereas Filter Overdrive applies distortion to the sound's full frequency spectrum before the filter.

Filter Divergence

Displayed as: FltDiverge
Initial value: 0
Range of adjustment: 0 to 127

This parameter re-creates the subtle effect of poor filter calibration found on early analogue synths. The filter for each voice is deliberately detuned by a different, fixed amount. The effect will be more apparent when the filter is close to resonance.

External Audio Input Routing

Displayed as: AudioInput
 Initial value: Off
 Range of adjustment: Off, PreFilt, PostFilt

Stereo audio from external equipment connected to Summit's external inputs (10) can be inserted into the signal processing paths of each synth either before (PreFilt) or after (PostFilt) the filter section. Stereo audio sent through the filter will be summed to mono. Audio sent directly to the FXs (in the Global Settings menu) will not be summed and heard in full stereo.

When a Multi Patch is selected, you can independently select how the external signal is routed to either Part A or Part B, or both. Note that an external audio signal will not be heard if the VCA is not being triggered. If no notes are being played, the VCA is not being opened by the keyboard and no audio can pass through.

t When using Summit to process external audio in the same way as you would use an FX processor, you can turn down the mixer inputs (Oscillators, Noise and Ring Mod) so their sounds is not combined with the external signal. If you then hold a note on and press Key Latch, the VCA will remain open at all times, allowing the external signal to be constantly processed.

t When using Summit to process external audio, it is important to remember that the number of voices held open can affect the external audio's input level. The more voices held open, the more "instances" there are of the external signal being passed through the synth's processing. However, if too many voices are used it can cause unwanted level clipping. You should experiment, but for the best results, one or two notes will often provide enough of a desired signal for processing.

Note that the external audio inputs may also be routed to the FX section. This routing is completely independent of the that enabled by AudioInput, and is enabled in the Settings menu. See page 42.

Voice Menu Page 4:

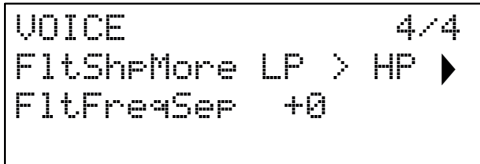

Dual Filter Options

Displayed as: FltShpMore
 Initial value: LP > HP
 Range of adjustment: LP > HP, LP > BP, HP > BP, LP + HP, LP + BP, HP + BP, LP + LP, BP + BP, HP + HP

As explained in the Filter Section description (see page 27), Summit offers two separate filters, each of which may be configured as low-pass, band-pass or high-pass by the Filter section's Shape control [58]. For the three settings LP, BP and HP, the Slope control [59] inserts either a single filter (12dB) or two identical filters in series (24dB) into the signal path. When Slope is set to Dual, the Voice menu page above is displayed and Slope is fixed at 12dB.

The FltShpMore parameter offers nine further combinations of the two filters. The first three, those including a '>' symbol, place two different filters in series, while the other six, those including a '+' symbol, place two filters in parallel. Note that in the case of parallel configurations, the two filters may be of the same type.

These dual filter options give the filter sections greatly increased flexibility over conventional designs employing a single, configurable filter. While the main Frequency control [60] continues to adjust the cut-off (or centre) frequency of both filters, the second parameter on this page, FltFreqSep, allows the two cut-off (or centre) frequencies to be different, or "separated".

Series and parallel combinations of two filters result in radically different overall frequency responses. With filters in series, the combined effect is subtractive: the harmonic content of the signal after the first filter will already have been reduced by its action, and will then be further reduced by the second. Therefore frequencies will be removed by both filters.

Conversely, the combined effect of parallel filters may be considered as additive, because the same signal is applied to both filters, so frequencies removed by one filter may be passed by the other, depending on their relative type and cut-off (or centre) frequencies.

In general, combining filters in parallel is likely to produce a response shape with a peak or dip between the frequencies of the two filters, but a wide range of shapes can be created by combining two filters of different types. The value of the "separation" parameter, FltFreqSep (see below), also has a major effect on the resulting frequency response.

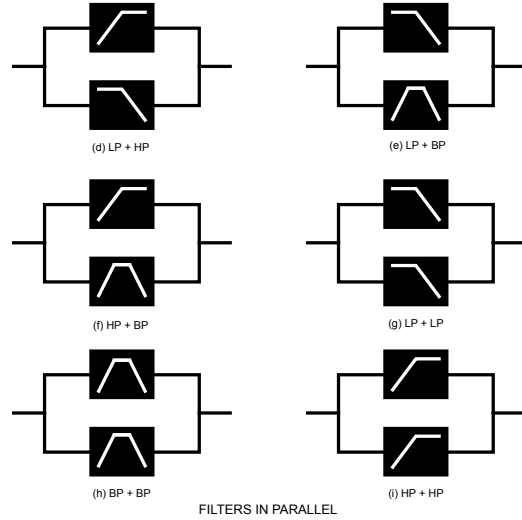
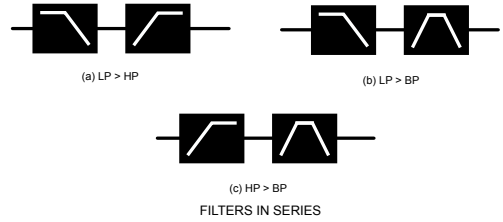

Filter frequency separation

Displayed as: FltFreqSep
 Initial value: 0
 Range of adjustment: -64 to +63

Two filters configured in either series or parallel by selecting one of the dual filter options may have different frequencies. The difference – or separation – of the two filter frequencies is set by the FltFreqSep parameter. When separation is zero, the two filters have the same frequency.

Positive values of FltFreqSep will lower the frequency of the first filter while increasing that of the second, thus "separating" the response curves of the two filter sections. The converse applies with negative values: the frequency of the first filter increase while that of the second decreases, so the frequencies effectively "cross over".

The audible effect of these options will largely depend on the two filter types selected by FltShpMore. The "first" and "second" filters referred to in the previous paragraph are the two listed in the FltShpMore setting, e.g., with FltShpMore set to HP + BP, the "first" filter will be a high-pass type and the second a band-pass type.

In all dual filter options, the resultant frequency response from the combination will have two turning points if FltFreqSep is set to something other zero, thereby giving the two filters different frequencies. Frequency always adjusts the overall filter combination regardless of the separation, but will maintain the "offset" between the two cut-off (or centre) frequencies – as a constant octave value – as it is varied.

The Oscillator Section

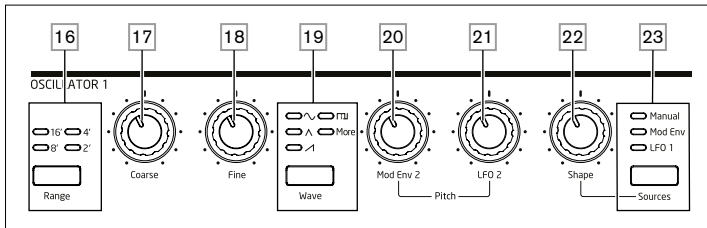

The Oscillator section for each of Summit's two synths consists of three identical oscillators, each with its own set of controls. Therefore, the following descriptions apply equally to any of the oscillators.

Oscillator Waveform

The **Wave** button [19] selects one of five wave shape options: four are the common fundamental waves, \sim Sine, \wedge Triangle, \nearrow (rising) Sawtooth and \square Square/Pulse. The fifth option, **more**, allows selection from a range of 60 further wavetables, accessed by the **WAVEFORM** parameter in the **Osc** menu. The LEDs confirm the waveform option currently selected. Note that the display immediately changes to the **Osc** menu, showing the **WAVEFORM** parameter for the oscillator being adjusted, as soon as **more** is selected. The last 10 slots in the **WAVEFORM** section are user configurable and can be loaded from the Novation Components software.

Oscillator Pitch

The three controls **Range** [16], **Coarse** [17] and **Fine** [18] set the Oscillator's fundamental frequency (or Pitch). The **Range** button selects using traditional "organ-stop" units, where 16' gives the lowest frequency and 2' the highest. Each doubling of stop length halves the frequency and thus transposes the pitch of a note played at the same position on a keyboard down one octave. When **Range** is set to 8', the keyboard will be at concert pitch with Middle C in the centre. The LEDs confirm the stop length currently selected.

The **Coarse** and **Fine** rotary controls adjust the pitch over a range of 1 octave and 1 semitone respectively. The OLED display shows the parameter value for **Coarse** in semitones (12 semitones = 1 octave) and **Fine** in cents (100 cents = 1 semitone).

Summit is not limited to traditional "Western" note intervals, nor to the standard equal-tempered scale. You can reprogram the keyboard in almost any way by using Tuning Tables; these are described in detail at page 26.

Pitch Modulation

The frequency of each Oscillator can vary by modulating it with either (or both) LFO 2 or the Mod Env 2 envelope. The two **Pitch** controls, **Mod Env 2 Depth** [20] and **LFO 2 Depth** [21] control the depth – or intensity – of the modulation sources. (Many other pitch modulation possibilities are available by using the Modulation Matrix – see page 38.)

Each Oscillator has a Depth control for modulation by Modulation Envelope 2. Adding envelope modulation can give some interesting effects, with the oscillator pitch altering over the duration of the note as it is played. A **Mod Env 2** parameter value of 30 shifts the pitch of one octave for the maximum level of the modulation envelope (e.g., if sustain is at maximum). Negative values invert the sense of the pitch variation; i.e., the pitch will fall during the attack phase of the envelope if **Mod Env 2** has a negative value.

Each Oscillator also has a Depth control for modulation by LFO 2. Adding LFO Modulation can add a pleasing vibrato when a triangle LFO waveform is used, and the LFO speed is set neither too high nor too low. A sawtooth or square LFO waveform will produce rather more dramatic and unusual effects. Oscillator pitch can be varied by up to five octaves, but the LFO 2 depth control is calibrated to give finer resolution at lower parameter values (less than ± 12), as these are generally more useful for musical purposes.

Negative values of LFO 2 Depth "invert" the modulating LFO waveform; the effect will be more obvious with non-sinusoidal LFO waveforms, e.g., with positive Depth values a falling sawtooth LFO waveform will cause the oscillator pitch to lower and then rise sharply before lowering again, but if Depth has a negative value, the pitch variation will be the opposite.

Waveform Shape

Summit lets you modify the shape of the selected waveform; this will alter the harmonic content and thus the timbre of generated sound. The degree of modification – or deviation from the original waveform shape – can be varied both manually and as a modulation. The modulation sources available using the panel controls are Mod Env 1 and LFO 1; any other mod source may be selected using the Modulation Matrix – see page 38

The **Source** button [23] assigns the **Shape Amount** control [22] to adjust the amount of waveform alteration by one of the three sources. Note that all three possible sources – **Manual**, **Mod Env 1** and **LFO 1** may be used in any combination, each with a different value of **Shape**: their effect is additive.

When set to **Manual**, **Shape** lets you alter the waveform shape directly; the parameter range is -63 to +63, where 0 results in an unmodified waveform. The sonic effect of **Shape** will depend on the waveform in use.

When the Sine waveform is selected, a non-zero **Shape** parameter causes the sine wave to become asymmetric, resulting in the addition of upper harmonics. Varying **Shape** with Triangle or Sawtooth waveforms also modifies the wave shape and the harmonic content.

When Square/Pulse is selected as the waveform, **Shape** will vary the pulse width: a value of 0 produces a 1:1 square wave. The timbre of the "edgy" square wave sound can be modified by varying the pulse width, or duty cycle, of the waveform. Extreme clockwise and anticlockwise settings of **Shape** produce very narrow positive or negative pulses, with the sound becoming thinner and more "reedy" as the control is advanced. When fully anticlockwise (parameter value -64), the square wave assumes a duty cycle of 0% and is thus "off". When varied to this degree by, e.g., adding LFO modulation, a rhythmic character can be added to the oscillator waveform.

When **Wave** [19] is set to **more**, **Shape** sweeps through the wavetable's waveform (selected by the **WaveMore** parameter in the **Osc** Menu) by interpolating across the five indexes of the selected wavetable to produce a "morphing" of two adjacent indexes: the sonic effect of this will vary greatly depending on the active patch and the wavetable in use. Each wavetable is actually a bank of five waveforms, between which you can interpolate with the **Shape** control. We recommend you experiment altering **Shape** with different waveforms to hear the effect. See also the **WAVEFORM** menu option described below.

Waveform shape may be modulated further by either (or both) Mod Env 1 or LFO 1, with the amount of waveform modification due to each individually adjustable by **Shape**, according to the setting of **Source**. With pulse waveforms, the sonic effect of LFO modulation is dependent on the LFO waveform and speed used, while using envelope modulation can produce some good tonal effects, with the harmonic content of the note changing over its duration.

The Oscillator Menu

The following additional Oscillator parameters are available in the **Osc** menu. Each of the three oscillators has two menu pages; the parameters available for each oscillator are identical. There are also two further pages (**OSC COMN** pages, 1/8 and 2/8), with parameter controls common to all three oscillators.

Common Oscillator pages:

The parameters available on the Common menu pages affect all three oscillators.

The default menu display is shown below:

```
OSC COMN 1      1/8
Diverge         0
Drift           0
TuningTable     0
```

```
OSC COMN 2      2/8
KeySync         Off
Noise LPF       127
Noise LPF       0
```

Diverge

Displayed as: Diverge
Initial value: 0
Range of adjustment: 0 to 127

Each Voice is generated by three oscillators within the FPGA, giving a Summit a total of 48 oscillators. Diverge applies small pitch variations independently to each of these 48 oscillators. The effect of applying this is that each voice will have its own tuning characteristic. This adds a further interesting colouration to the sound quality and can be used to bring the synth alive. The parameter sets the degree of variation.



Try setting BendRange to different values for each of the three oscillators. This can produce some interesting triad chords when the pitch wheel is moved.

Oscillator Drift

Displayed as: Drift
 Initial value: 0
 Range of adjustment: 0 to 127

Summit has a dedicated low frequency oscillator which can be used to apply a slight meandering detune to the three Oscillators. This is to emulate the oscillator drift of traditional voltage controlled analogue synths: by applying a controlled amount of detuning, the oscillators become slightly out of tune with each other, adding a "fuller" character to the sound. Unlike Diverge, the drift effect changes over time.

Tuning Table

Displayed as: TuningTable
 Initial value: 0
 Range of adjustment: 0 to 16

Summit normally operates with the tuning of a standard piano keyboard. The data which relates the notes of the keyboard (or other MIDI transmitting device connected to Summit) to the oscillator pitch intervals is called a Tuning Table: the default is Table 0, which cannot be edited. The TuningTable parameter lets you select one of 16 alternative tuning tables, which you can send to Summit via Novation Components, or create yourself. See page 26 for details of how to create a Tuning Table. Note that all 16 Tuning Tables are initially copies of Tuning Table 0, so their effect will not be apparent until a different table has been created.

Key Sync

Displayed as: KeySync
 Initial value: Off
 Range of adjustment: Off or On

With KeySync set Off, Summit's three oscillators are free-running and even when set accurately to the same pitch, may not be in phase with each other. This often does not matter, but if the Ring Modulator or FM effects are in use, the out-of-phase effect may not produce the result needed. To overcome this, KeySync may be selected to On, which ensures the oscillators always start generating their waveforms at the start of a cycle when a key is pressed.

Low-pass noise filter

Displayed as: NoiseLPF
 Initial value: 127
 Range of adjustment: 0 to 127

In addition to the three Oscillators, Summit also has a noise generator. Noise is a signal comprising a wide range of frequencies, and is a familiar "hissing" sound. This Noise filter is a low-pass type: restricting the bandwidth of the noise alters the characteristic of the "hiss", and you can adjust the filter cut-off frequency to do this. The parameter's default value of 127 sets the filter "fully open". Note that the noise generator has its own input to the mixer, and in order to hear it in isolation, its input will need to be turned up and the oscillator inputs turned down. (See "The Mixer Section" on page 27)

High-pass noise filter

Displayed as: NoiseHPF
 Initial value: 0
 Range of adjustment: 0 to 127

This filter performs the same function as NoiseLPF, except it is a high-pass filter, and therefore as the parameter value is increased, the filter's higher frequencies are passed and more low-frequency content of the noise signal is rejected. The parameter's default value of zero sets the filter "fully open". The effect of applying this is that each voice will have its own tuning characteristic.

Per-Oscillator pages:

The default menu displays for Oscillator 1 are shown below:

```
OSCILLATOR 1      3/8
WaveMore         BS sine ▶
FixedNote        Off
BendRange        +12
```

```
OSCILLATOR 1      4/8
Vsync            0 ▶
SawDense         0
DenseDet         64
```

More Waveforms

Displayed as: WaveMore
 Initial value: BS sine
 Range of adjustment: See list on page 45 for a list of wavetables

Summit includes a set of wavetables, so you can generate a broader palette of sounds than the simple sine, triangle, sawtooth and pulse waveforms can provide. Each wavetable is a bank of five custom waveforms, you can interpolate with the Shape control [22].

The WaveMore parameter selects the oscillator wavetable when Wave [19] is set to more. The name of the wavetable appears on Row 2 of the display and gives a clue to the nature of the sound. As with many other aspects of Summit, you will gain an understanding of wavetables by experimenting, and by adjusting the Shape control. In many cases, this will alter the sonic nature of the selected waveform quite dramatically.

The last 10 slots in the more waveforms menu contain user waveforms you can generate in the Components software. Here you can design store and manage waveforms you create.

Single Fixed Note

Displayed as: FixedNote
 Initial value: Off
 Range of adjustment: Off, C -2 to D# 5

Some sounds need not be chromatic pitch-dependent. Examples would be certain percussion sounds (e.g., bass drums), and sound effects, such as a laser gun. It is possible to assign a fixed note to a patch, such that playing any key on the keyboard generates the same sound. The pitch on which the sound is based may be any semitone note in a range of over eight octaves. With the parameter set Off, the keyboard behaves as normal. With it set to any other value, every key plays the sound at the pitch corresponding to the value.

Pitch Wheel Range

Displayed as: BendRange
 Initial value: +12
 Range of adjustment: -24 to +24

The keyboard pitch wheel can vary the pitch of each of the oscillators by up to two octaves, up or down: BendRange may have a different value for each oscillator. The units are semitones, with a default value of +12, moving the pitch wheel up will increase the pitch of the notes by one octave, and moving it down takes them down an octave. Setting the parameter to a negative value reverses the operation of the pitch wheel. Many of the factory patches either have this parameter set to +12, giving a pitch wheel range of ±1 octave, or to +2 for a range of 1 tone.



Try setting BendRange to different values for each of the three oscillators. This can produce some interesting triad chords when the pitch wheel is moved.

Oscillator Sync

Displayed as: VSync
 Initial value: 0
 Range of adjustment: 0 to 127

Oscillator Sync is a technique of using one oscillator (the master) to add harmonics to another (the slave). Summit provides Oscillator Sync by using a virtual oscillator for each of the three main oscillators. The virtual oscillators are not heard, but the frequency of each is used to re-trigger that of the main oscillator.

The VSync parameter controls the frequency offset of the virtual oscillator relative to the (audible) main oscillator. The nature of the resulting sound varies as the parameter value is altered because the virtual oscillator frequency increases in proportion to the main oscillator frequency as the parameter value increases.

When the VSync value is a multiple of 16, the virtual oscillator frequency is a musical harmonic of the main oscillator frequency. The effect is a transposition of the oscillator that moves up the harmonic series, with values between multiples of 16 producing more discordant effects.

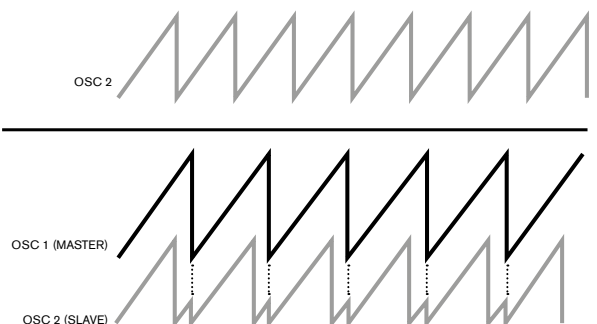



Vsync may be controlled for any or all oscillators using the Modulation Matrix. See page 38 for details of how to use the Matrix.



To get the best out of Vsync, try modulating it using the LFO. Try assigning it to the MOD wheel for real-time control.

Sawtooth Density

Displayed as: SawDense
Initial value: 0
Range of adjustment: 0 to 127

Sawtooth Density only affects sawtooth waveforms. It adds copies of the oscillator waveform to itself. Two additional virtual oscillators are used for this, producing a "thicker" sound at low to medium values, but if the virtual oscillators are detuned slightly (see Density Detuning below), a more interesting effect can be obtained.

Density Detuning

Displayed as: DenseDet
Initial value: 64
Range of adjustment: 0 to 127

Density Detuning should be used in conjunction with Sawtooth Density. It detunes the virtual density oscillators, and you will notice not only a thicker sound, but a beating as well.



You can use the Sawtooth Density and Density Detuning parameters to "thicken" the sound, and simulate the effect of additional Voices. You can use the Unison and Unison Detune parameters in the **Voice Menu** to create a similar effect, but using Density and Density Detune have the advantage of not needing to use additional Voices.

The Mixer Section

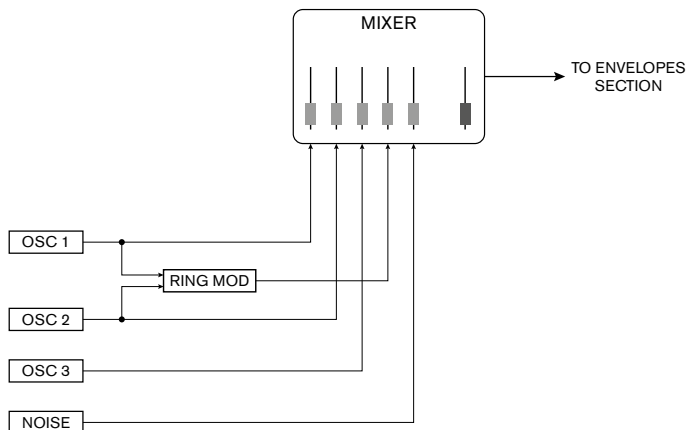
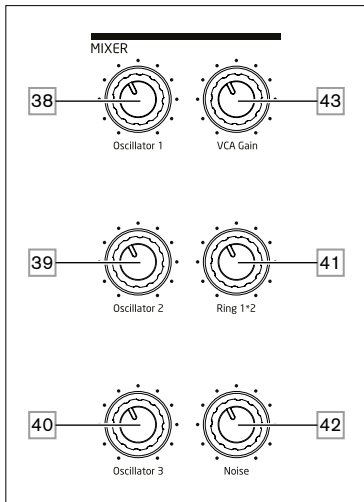

The outputs of the various sound sources can be mixed together in any proportion to produce the overall synth sound, using what is essentially a standard 5-into-1 mono mixer.

The three Oscillators, the Noise source and the Ring Modulator output each have level controls, **Osc 1** [38], **Osc 2** [39], **Osc 3** [40], **Noise** [42] and **Ring 1*2** [41] respectively. There is also a "master" level control, **VCA Gain** [43], which sets the output level of the mixer. As the mixer section precedes the Envelopes section, this control scales the DAHDSR amplitude envelope.



Summit is capable of producing levels in the mixer section that can clip if all sources are turned up to maximum. It may be necessary to balance the levels either by turning the sources down or by reducing the **VCA Gain** control [43] to ensure that audible clipping does not occur.

The Filter Section

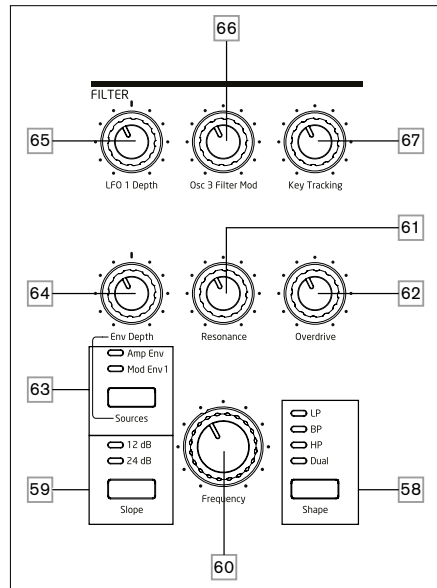

The sum of the sounds from the mixer, plus any external audio inputs, is fed to the analogue Filter Section. The filter is used to modify the harmonic content of this combined sound. In Single mode, the filter affects all voices: in Multi mode, you can apply different filtering characteristics to each of the two Parts. Summit's filters are of analogue design, and have an extensive set of configuration, modulation and control options.

Filter type and slope

The **Shape** button [58] selects one of three filter types: low-pass (**LP**), band-pass (**BP**) or high-pass (**HP**). A fourth option, **Dual**, gives access to a wide range of further filter configuration options through the Voice menu.

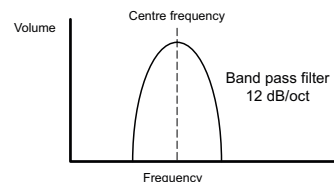
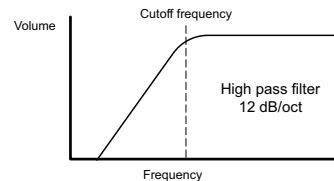
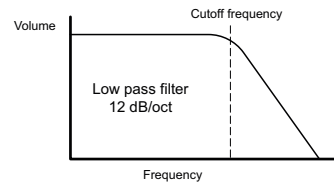

The filter section of each of Summit's two internal synths is devised around analogue filters with a slope of 12 dB/octave: each voice played includes two such filters.

The **Slope** button [59] sets the degree of rejection applied to out-of-band frequencies; in the **12 dB** setting, only one filter is placed in circuit, but when set to **24 dB**, two filter sections are cascaded (placed in series), resulting in a steeper slope. An out-of-band frequency will be attenuated more severely with the **24 dB** setting.

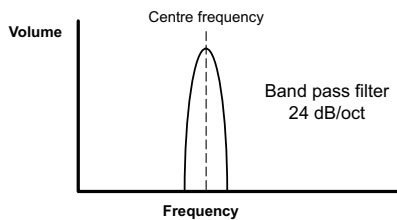
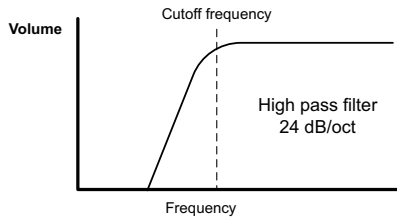
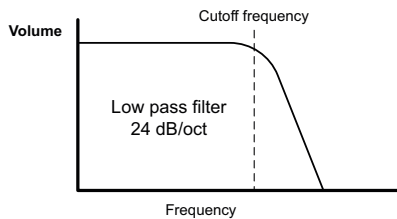

The **Slope** settings only have relevance when a low-pass, band-pass or high-pass filter is selected by the **Shape** button. The diagrams below illustrate the effect of **Slope** with **Shape** set to **LP** (the same principle applies to **BP** and **HP**):

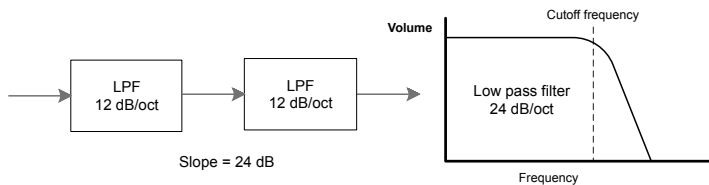
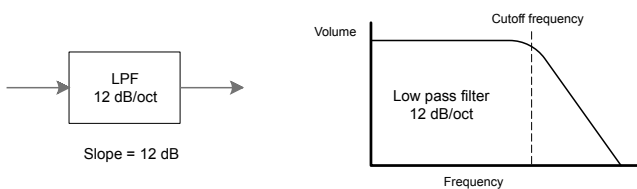

If **Shape** is set to **Dual**, page 4 of the **Voice** menu is displayed on the OLED and **Slope** is set to **12 dB** (Note - the Slope LEDs may still indicate **24 dB** if this was the last setting with a single filter configuration selected). This menu page lets you combine the two filter sections in several other ways; specifically, by allowing combinations of two different filter types.

Frequency

The large rotary **Frequency** control [60] sets the cut-off frequency of the filter when **Shape** is set to **HP** or **LP**. With **BP** selected, **Frequency** sets the centre frequency of the filter's pass-band.

Sweeping the filter frequency manually will impose a "hard-to-soft" characteristic on almost any sound.

Frequency is more complex when **Shape** is set to **Dual** and you select one of the dual filter combinations. See the section on the **Voice** menu on page 22 for more details.

Resonance

The **Resonance** control [61] adds gain to the signal in a narrow band of frequencies around the frequency set by the **Frequency** control. It can accentuate the swept-filter effect considerably. Increasing the resonance parameter is good for enhancing modulation of the cut-off frequency, creating an edgy sound. Increasing **Resonance** also accentuates the action of the **Frequency** control, giving it a more pronounced effect.

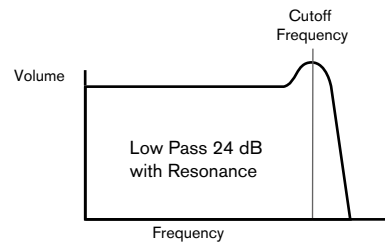

Setting **Resonance** to a high value can greatly increase the output signal level – the synth volume – and in some cases can cause unwanted clipping. This can be compensated for by adjusting **VCA Gain** [24].

Filter modulation

The filter's Frequency parameter may be modulated - using the physical controls - by the output of LFO 1, the Amplitude Envelope, Modulation Envelope 1, Oscillator 3, or any combination of these.

Modulation by LFO 1 is controlled by the **LFO 1 Depth** control [65], and by the **Env Depth** control [64] for either of the two envelopes. The **Env Depth** control is assigned to the Amplitude Envelope by selecting **Amp Env** with the **Source** button [63], and to Modulation Envelope 2 by setting **Source** to **Mod Env**. Both mod sources may be used simultaneously, with the **Env Depth** control adjusting only the currently selected envelope. As with many other control routings between synth sections, a great many more options for modulating the filter may be explored using the Modulation Matrix (see page 38).

Note that only one LFO – LFO 1 - is available for filter modulation using the panel controls. (LFOs 2 -4 may be patched to modulate the filter using the Modulation Matrix.) Filter frequency can be varied by up to eight octaves.

Negative values of **LFO 1 Depth** "invert" the modulating LFO waveform; the effect of this will be more obvious with non-sinusoidal LFO waveforms and low LFO rates. With positive Depth values a falling sawtooth LFO waveform will cause the filter frequency to drop and then rise sharply before lowering again, but if Depth has a negative value, the filter frequency variation will be the opposite.

Modulating the filter frequency with an LFO can produce some unusual "wah-wah" type effects. Setting LFO 1 to a slow speed can add a gradual hardening and then softening edge to the sound.

When the filter's action is triggered by an envelope, the filter action changes over the duration of the note. By adjusting the Envelope controls carefully, this can produce some very pleasing sounds, as for example, the spectral content of the sound can be made to differ considerably during the attack phase of the note compared to its "fade-out".

Env Depth lets you control the "depth" and "direction" of the modulation; the higher the value, the greater the range of frequencies over which the filter will sweep. Positive and negative values make the filter sweep in opposite directions, but the audible result of this will be further modified by the filter type in use.

Summit also allows direct modulation of the Filter frequency using Oscillator 3: this is controlled by the **Osc 3 Filter Mod** control [66]. The intensity of the resulting effect is dependent on the control setting, but also almost all Osc 3 parameters - range, pitch, waveform, pulse width, plus any modulation applied to the Oscillator - can have a profound effect on the filter's behaviour.



Many additional filter configurations are available via the **Voice** menu. See **Dual Filter Options** and **Filter Frequency Separation** on page 24



Try adding Osc 3 Filter Mod while sweeping Osc 3 pitch with the pitch wheel.

Filter tracking

The pitch of the note played can be made to alter the cut-off frequency of the filter. This relationship is controlled by the setting of the **Key Tracking** control [67]. At the maximum value (127), the filter cut-off frequency moves in semitone steps with the notes played on the keyboard – i.e., the filter tracks the pitch changes in a 1:1 ratio. This means when playing two notes an octave apart, the filter cut off frequency will also change by one octave. At minimum setting (value 0), the filter frequency remains constant, whatever note(s) are played on the keyboard.



When using filter resonance as an additional oscillator, set **Key Tracking** to maximum (127) to allow the filter to be played 'in tune'.

Overdrive

The filter section includes a dedicated drive (or distortion) generator; the **Overdrive** control [62] adjusts the degree of distortion treatment applied to the signal. The drive is added before the filter.



Two further Filter-related parameters – **Filter Post Drive** and **Filter Divergence** – are also available for adjustment in the Voice menu. See page 23.

The Envelopes Section

Each of Summit's two internal synths generates three envelopes each time a key is pressed, which can be used to modify the synth sound in many ways. The envelope controls are based on the familiar ADSR concept, though Summit adds two further envelope phases, Delay and Hold, which are adjusted in the **Env** menu. Thus we refer in this User Guide to the DAHDSR sequence.

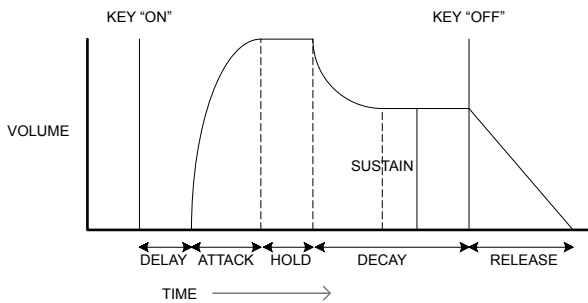

The DAHDSR envelope can be most easily visualised by considering the amplitude (volume) of a note over time. The envelope describing the "lifetime" of a note can be split into six distinct phases:

- **Delay** – the time from when the key is struck to when the Attack phase of the envelope commences. The note is not audible during this phase. For most regular playing styles, Delay will be set to zero, but it is a useful parameter when setting up special sound effects.
- **Attack** – the time it takes for the note to increase from zero (i.e., from the end of the Delay phase) to its maximum level. A long attack time produces a "fade-in" effect.
- **Hold** – the time for which the note stays at the level reached in the Attack phase.
- **Decay** – the time it takes for the note to drop in level from the maximum value reached at the end of the Attack phase (and maintained throughout the Hold phase) to a new level, defined by the Sustain parameter.
- **Sustain** – this is an amplitude value, and represents the volume of the note after the Attack, Hold and initial Decay phases – i.e., while holding the key down. Setting a low value of Sustain can give a short, percussive effect (providing the Attack, Hold and Decay times are short).
- **Release** – This is the time it takes for the note's volume to drop back to zero after the key is released. A high value of Release will cause the sound to remain audible (though diminishing in volume) after the key is released.

Although the above discusses DAHDSR in terms of volume, note that each of Summit's two Parts has the facilities of three separate envelope generators, referred to as **Amp Envelope**, **Mod Envelope 1** and **Mod Envelope 2**. All three envelopes per Part are generated each time a key is struck, though each may have a completely different set of parameters.

- **Amp Env** controls the amplitude of the synth signal, and is always routed to the VCA in the output stage (see page 21). Summit also allows Amp Env to directly modulate the frequency of the Filter section using panel controls.
- **Mod Env 1 & 2** – the two modulation envelopes – are routed to various other sections of Summit, where it can be used to alter other synth parameters over the duration of the note. These are:
 - Mod Env 1 can modulate the waveform shape of any of the three Oscillators, at a degree set by the **Shape** controls [22] when the associated **Source** button [23] is set to **Mod Env 1**.
 - Mod Env 1 may also modulate the filter frequency, at a degree set by the **Env Depth** control [64] when the **Source** button [63] is set to **Mod Env 1**.
 - Mod Env 2 can modulate the pitch of any of the three Oscillators, at a degree set by the **Mod Env 2** Depth controls [20].

It must be emphasised that the above routings are only those available directly using Summit's top panel controls: many more routing options are available using the Modulation Matrix (see page 38).

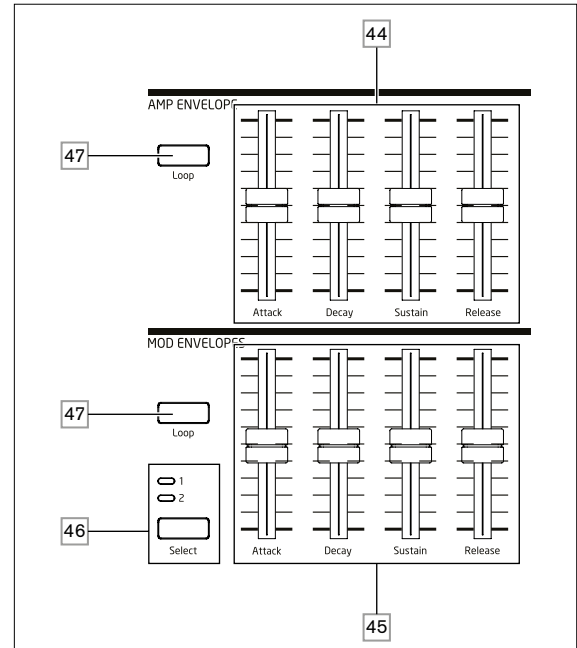

Summit's Envelope section has two sets of four slider controls, one set for **Amp Env**, the other for either **Mod Env 1** or **Mod Env 2**, as selected by the **Select** button [46]. The sliders are dedicated to four of the DAHDSR parameters (attack, decay, sustain and release); the descriptions below describe the effect of the **Amp Envelope** controls as amplitude variations are more easily visualised, though the effect of the corresponding **Mod Envelope** controls is identical. The two remaining envelope phases, Delay and Hold are adjusted in the Envelopes Menu.

- **Attack** - sets the note's attack time. With the slider at its lowest position, the note attains its maximum level immediately the key is pressed; with the slider in its uppermost position, the note takes over 18 seconds to reach its maximum level.
- **Decay** - sets the time the note takes to decay from the level reached in the Attack phase and maintained throughout the Hold phase, to that defined by the Sustain parameter. Maximum decay time is approx. 22 seconds.
- **Sustain** - sets the volume of the note after the decay phase. A low Sustain value with a higher Decay phase will have the effect of emphasising the start of the note; with the slider fully down, the note is inaudible when the decay time has elapsed.
- **Release** - Many sounds acquire some of their character from the notes remaining audible after the key is released; this "hanging" or "fade-out" effect, with the note gently dying away naturally (as with many real instruments) can be very effective. Summit has a maximum release time of over 24 seconds, but shorter times will probably be more useful! The relationship between the parameter value and the Release Time is not linear: this means much finer control is available over shorter release times.



With a high Sustain setting and zero Attack, Decay and Release, the envelope will act like an On/Off control when the key is pressed and released: the note will begin immediately the key is pressed and stop immediately when it is released. This can be reminiscent of the style of key control found on traditional organs.

The Envelopes Menu

The following Envelope parameters are available in the **Env** menu. Each Envelope has two menu pages; the parameters available for each Envelope are identical, except that the default value of the **MonoTrig** parameter for the Mod Envelopes is **Re-Trig**.

The default menu displays for the Amp Envelope are shown below:

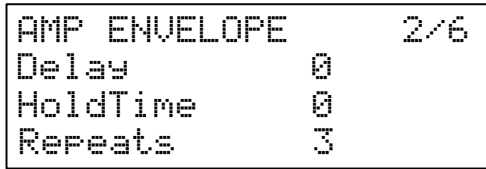
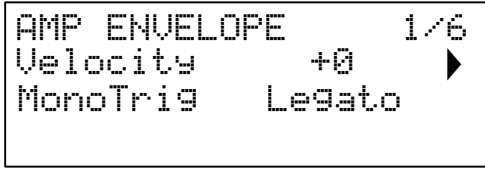

Velocity

Displayed as: Velocity
Initial value: 0
Range of adjustment: -64 to +63

Velocity does not modify the shape of the DAHDSR envelope in any way, but adds touch sensitivity to the sound. In the case of the Amplitude Envelope, setting a positive parameter value will mean the harder you play the keys, the louder will be the sound. If set to zero, the volume is the same regardless of how the keys are played. The relationship between the velocity at which a note is played and volume is determined by the value. Note that negative values have the inverse effect.

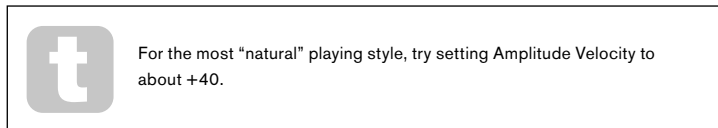

The sonic effect of the corresponding Velocity parameter for the two Modulation Envelopes will depend on what the Envelopes are used for: for example, if they are used to modulate Filter Frequency (a common application), a positive Velocity parameter will result in a greater degree of filter action when the keys are struck harder.

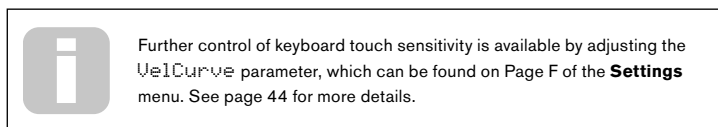

Multi-Triggering

Displayed as: MonoTrig
Initial value: Legato
Range of adjustment: Legato or Re-Trig

When this parameter is set to **Re-Trig**, each note played will trigger its full DAHDSR envelope, even if other keys are held down. In **Legato** mode, only the first key to be pressed will produce a note with the full envelope, all subsequent notes will omit the Attack and Decay phases, and sound only from the start of the Sustain phase. "Legato" literally means "smoothly", and this mode aids this style of playing.

It is important to appreciate for the Legato mode to be operative, **Mono** or **MonoLG** modes must be selected in the **VOICE** control area of the panel – it will not work with polyphonic voicing or **Mono2** mode. See page 22.

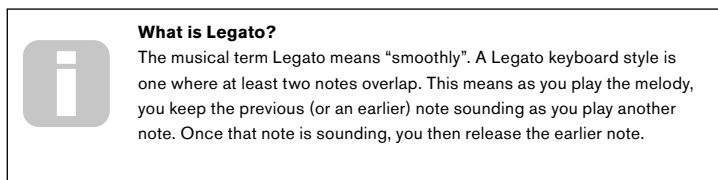

Delay

Displayed as: Delay
Initial value: 0
Range of adjustment: 0 to 127

Summit adds two additional phases to the traditional ADSR envelope: the first of these is **Delay**. When **Delay** has the default value of 0, the envelopes commence their Attack phase as soon as a key is struck. **Delay** inserts a variable time lag between striking the key and the start of the remainder of the AHDSR envelope. At its maximum value of 127, the envelope does not begin until 10 seconds after the key is pressed. Delays much shorter than this are likely to be of more interest, and the relationship between the parameter value and the delay time has been deliberately made exponential to allow for this: a value of about 85 introduces a delay of one second.

Hold time

Displayed as: HoldTime
Initial value: 0
Range of adjustment: 0 to 127

The Hold parameter is a further additional phase of the envelope: many synthesisers only offer control of an ADSR envelope but Summit allows further control of the note's "lifetime". Once the note has completed the Attack phase, the envelope will remain at its maximum level for a determined set by **HoldTime**. In terms of the Amplitude Envelope, if **HoldTime** is not set to zero, the note will stay at its maximum volume for a finite time before reducing in volume over the time set by **Decay**. If **HoldTime** is set to zero, the Decay phase commences immediately the maximum level is reached at the end of the Attack phase. The maximum value of 127 corresponds to a hold time of 500 mS.

Repeats

Displayed as: Repeats
Initial value: On
Range of adjustment: 1 to 126, On

Repeats allows you to set "looping envelopes": when a note is struck, the Attack, Hold and Decay phases of the envelope can be made to repeat any number of times up to 126 before the sustain and release phases of the envelope are started. This looping function is enabled (and disabled) with the **Loop** button [47]. With **Loops** off, the DAHDSR envelope is followed as normal. When **Loop** is on, the value of **Repeats** sets the number of times the Attack, Hold and Decay envelope phases are implemented. When set to the default value of On, the Attack, Hold and Decay phases are repeated continuously until the note is released, when the release phase commences.

The LFO Section

Summit has four Low Frequency Oscillators (LFOs), denoted LFO 1 to LFO 4. LFO 1 and LFO 2 are per-voice; that is, their modulating effect is applied independently to each of the voices. Their primary parameters are immediately user-adjustable via panel controls: there are numerous further parameters in the **LFO** menu.

LFO 3 and LFO 4 are "global", in that their modulating effect is applied to the eight voices after they have been mixed together. This is particularly useful as these LFOs can be used to modulate FX parameters via the FX Modulation Matrix. Waveform and rate controls for LFO 3 and LFO 4 are provided on the panel; again, further parameters are available in the LFO menu.

All four LFOs are also available for routing to other parts of Summit via the Modulation Matrix.

LFO 1 and LFO 2 hardware controls

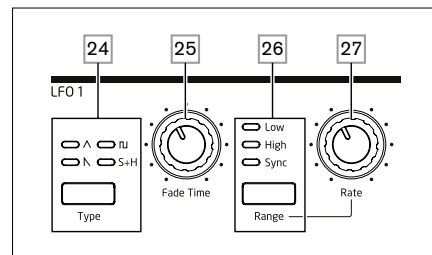

LFO 1 and LFO 2 are identical in terms of features, but their outputs may be directly routed using the panel controls to different parts of the synth and are thus used differently, as outlined below:

LFO 1:

- can modify the waveform shape of each oscillator when LFO1 is selected by the oscillator's **Source** button [23];
- can modulate the filter frequency; the amount of modulation is adjusted in the Filter Section with **LFO 1 Depth** control [65].

LFO 2:

- can modulate the pitch of each Oscillator; the amount of modulation is adjusted in the Oscillator Section with the **LFO 2 Depth** control [21]. This is the method of adding "vibrato" to a sound.

Either LFO may additionally be patched in the Modulation Matrix to modulate many other synth parameters.

LFO 1 & 2 Waveform

The **Type** button [24] selects one of four wave shapes – \wedge Triangle, \sloperight Sawtooth, \square Square or Sample and Hold. The LEDs above the button confirm the waveform selected.

LFO 1 & 2 Rate

The speed (or rate, or frequency) of each LFO is set by the **Range** button [26] and the rotary **Rate** control [27]. The **Range** button has three settings: **Low**, **High** and **Sync**. Selecting **Sync** reassigns the function of the **Rate** control, allowing the speed of the LFO to be synchronised to an internal or external MIDI clock, based on a sync value selected by the control. When **Sync** is selected, the OLED displays the LFO's `RateSync` parameter when the **Rate** control is moved: this allows you to choose the tempo division needed. See LFO Sync Rate table on page 45

LFO 1 & 2 Fade Time

LFO effects are often more effective when faded-in, rather than just 'switched on'; the **Fade Time** parameter sets how long the LFO output takes to ramp up when a note is played. The rotary control [25] is used to adjust this time. See also Fade Mode (page 32), where you can also make the LFO fade out after the Fade Time, or using a Gate setting, start or end abruptly after the Fade Time.

LFO 3 and LFO 4 hardware controls

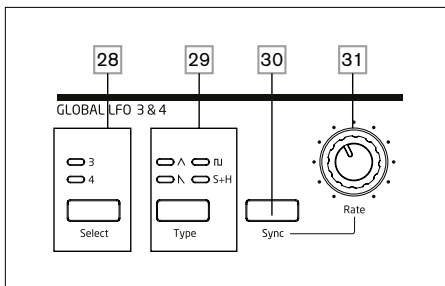

LFO 3 and LFO 4 share a set of panel controls which may be assigned to either LFO, and each has its own page in the LFO menu with further parameters. The LFO outputs are not routable using direct panel controls in the way that LFO 1 and LFO 2 are, but may be routed to any of the Modulation Matrix's destinations.

LFO 3 & 4 Select

The **Select** button [28] assigns the other controls on the **GLOBAL LFO 3 & 4** panel section to LFO 3 or LFO 4 respectively.

LFO 3 & 4 Waveform

The **Type** button [29] selects one of four wave shapes - \wedge Triangle, \sloperight Sawtooth, \square Square or Sample and Hold. The LEDs above the button confirm the waveform currently selected. Waveform selection may also be made from the LFO menu.

LFO 3 & 4 Rate

The speed (or rate, or frequency) of the selected LFO (LFO 3 or LFO 4) is set by the **Rate** control [30]. Selecting **Sync** [31] reassigns the function of the **Rate** control, allowing the speed of the LFO to be synchronised to an internal or external MIDI clock, based on a sync value selected by the control. When **Sync** is selected, the OLED displays the LFO's `RateSync` parameter when the **Rate** control is moved: this allows you to choose the tempo division needed. See LFO Sync Rate table on page 45. LFO 3/4 Rate may also be set from the LFO menu.

LFO 3 & 4 Sync

Pressing **Sync** [31] locks the LFO speed to an external or internal MIDI clock, to enable it to be synchronised to external equipment. The sync division factor is adjusted by the `LxRateSync` parameter (where x=3 or 4) in the LFO menu.

The LFO Menu

LFO1 and LFO 2 are 'per voice'. This is a very powerful feature of Summit (and other Novation synthesisers). For example, when an LFO is assigned to create vibrato, and a chord is played, each note of the chord will be varied at the same rate, but not necessarily in the same phase. There are various settings in the LFO Menu that control how the LFOs respond and lock together.

LFO 1 and LFO 2 each have three menu pages; the parameters available for LFO 1 and LFO 2 are identical.

As LFO 3 and LFO 4 are intended for the creation of additional modulation effects rather than fundamental tone generation, they are 'global' as opposed to 'per-voice', meaning that they can also be used to modulate FX parameters via the FX Modulation Matrix. They have one menu page each; the parameters available for LFO 3 and LFO 4 are identical.

LFO 1 and LFO 2: The default menu displays for LFO 1 are shown below:

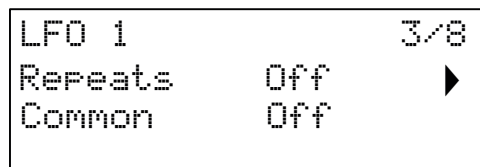
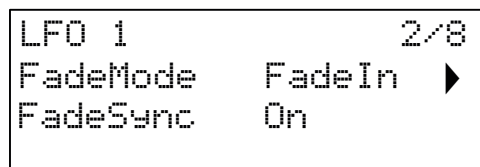
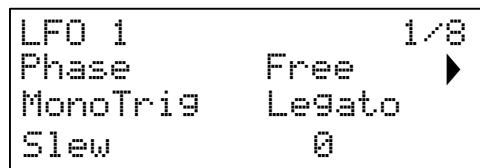

LFO Phase

Displayed as: Phase
Initial value: Free
Range of adjustment: Free; 0deg to 357deg (in 3deg increments)

Each LFO runs continuously 'in the background'. If the `Phase` is set to Free (the default), there is no way of predicting where the waveform will be when a key is pressed. Consecutive presses of a key will inevitably produce varying results. With all other values of `Phase`, the LFO will re-start at the same point on the waveform every time a key is pressed, the actual point being determined by the parameter value. A complete waveform has 360°, and the control's increments are in 3° steps. Thus a half-way setting (180deg) will cause the modulating waveform to start at half-way through its cycle.

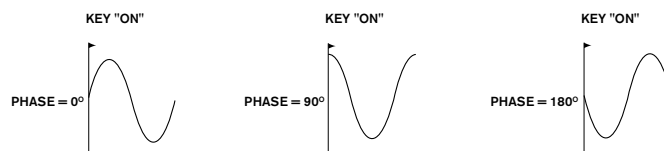

MonoTrig

Displayed as: MonoTrig
Initial value: Legato
Range of adjustment: Legato or Re-Trig

`MonoTrig` only applies to monophonic Voice modes (see page 22). Providing LFO `Phase` is not set to Free, the LFOs are re-triggered each time a new note is pressed. But if you are playing in legato style (literally "smoothly" – playing further keys while one key is still held), the LFOs will only re-trigger if `MonoTrig` is set to Re-Trig. If set to Legato, you will only hear the effect of re-triggering on the first note.

LFO Slew

Displayed as: SLEW
 Initial value: 0
 Range of adjustment: 0 to 127

SLEW has the effect of modifying the shape of the LFO waveform. Sharp edges become less sharp as Slew is increased. The effect of this on pitch modulation can be heard by selecting Square as the LFO waveform and setting the rate fairly low so when a key is pressed the output alternates between two tones. Increasing the value of SLEW will cause the transition between the two tones to become a "glide" rather than a sharp change. This is caused by the vertical edges of the square LFO waveform being slewed.

i

Note that SLEW has an effect on all LFO waveforms, but the sonic effect differs with waveform rate and type. As SLEW is increased, the time taken to reach maximum amplitude is increased, and can ultimately result in it never being achieved at all, though the setting at which this point is reached will vary with waveform.

SQUARE WAVE
NO SLEW

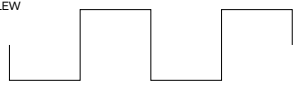

SMALL SLEW VALUE



LARGE SLEW VALUE



Fade Mode

Displayed as: FadeMode
 Initial value: FadeIn
 Range of adjustment: FadeIn, FadeOut, GateIn, GateOut

The function of the four possible settings of FadeMode are as follows:

1. **FadeIn** – the LFO's modulation is gradually increased over the time period set by the **Fade Time** control [25].
2. **FadeOut** – the LFO's modulation is gradually decreased over the time period set by the **Fade Time** control, leaving the note unmodulated.
3. **GateIn** – the onset of the LFO's modulation is delayed by the time period set by the **Fade Time** parameter, and then starts immediately at full level.
4. **GateOut** – the controlled parameter is fully modulated by the LFO for the time period set by the **Fade Time** parameter. At this time, the modulation stops abruptly.

Note that whichever of the Fade Modes is selected, it is always active; if you do not want to hear its effect, turn the **Fade Time** control [25] down to zero.

LFO Fade Sync

Displayed as: FadeSync
 Initial value: On
 Range of adjustment: Off or On

The setting of FadeSync only applies to monophonic voice modes (see page 22). FadeSync determines whether the time delay set by **Fade Time** is re-started each time a key is pressed. With FadeSync set to On (the default), the LFO fade time recommences; when set to Off, it is triggered only by the first note. This will only be of relevance when playing in legato style.

Repeats

Displayed as: Repeats
 Initial value: Off
 Range of adjustment: Off, 1 - 127

Repeats sets how many cycles of LFO waveform will be generated each time the LFO is triggered. So if set to 1, you will only hear the effect of any LFO modulation for a single cycle, and hence for a short duration (depending on the setting of **Rate**).

LFO Common Sync

Displayed as: COMMON
 Initial value: Off
 Range of adjustment: Off or On

Common Sync is only applicable to polyphonic voices. When COMMON is On, it ensures that the phase of the LFO waveform is synchronised for every note being played. When set Off, there is no such synchronisation, and playing a second note while one is already pressed will result in an unsynchronised sound as the modulations will be out of time. When LFOs are in use for pitch modulation (their most common application), having COMMON set to Off will give more natural results.

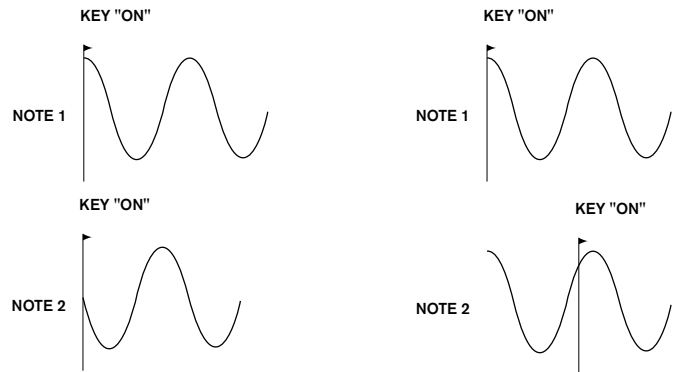

t

Set COMMON to On for an emulation of early analogue polyphonic synths.

LFO 3 and LFO 4: The default menu display for LFO 3 is shown below:

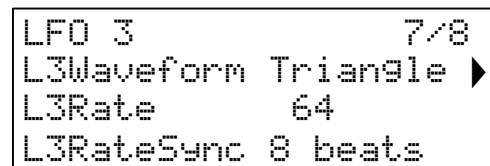

LFO 3/4 Waveform

Displayed as: LxWaveform (where x=3 or 4)
 Initial value: Triangle
 Range of adjustment: Triangle, Sawtooth, Square, Rand S/H

This parameter is the menu-based equivalent of the panel Type button [29], and performs the same function: setting the basic waveform for LFO 3 or LFO 4.

LFO 3/4 Rate

Displayed as: LxRate (where x=3 or 4)
 Initial value: 64
 Range of adjustment: 0 to 127

This parameter is the menu-based equivalent of the panel Rate rotary control [30], and performs the same function: setting the rate (frequency) of LFO 3 or LFO 4.

LFO 3/4 Rate Sync

Displayed as: LxRateSync (where x=3 or 4)
 Initial value: 8 beats
 Range of adjustment: See table at page 45 for full details

LFO Rate Sync allows the speed of the LFO to be synchronised to an internal or external MIDI clock: the parameter selects the sync division factor. For LFO Sync Rate to be operational, it must first be enabled with the **Sync** button [30].

The Arpeggiator

Summit has a versatile Arpeggiator (Arp) which allows arpeggios of varying complexity and rhythm to be played and manipulated in real-time. When the Arpeggiator is enabled and a single key is pressed, its note will be retrIGGERed. If you play a chord, the Arpeggiator identifies its notes and plays them individually in sequence (this is termed an arpeggio pattern or 'arp sequence'); thus if you play a C major triad, the notes making up the pattern will be C, E and G.

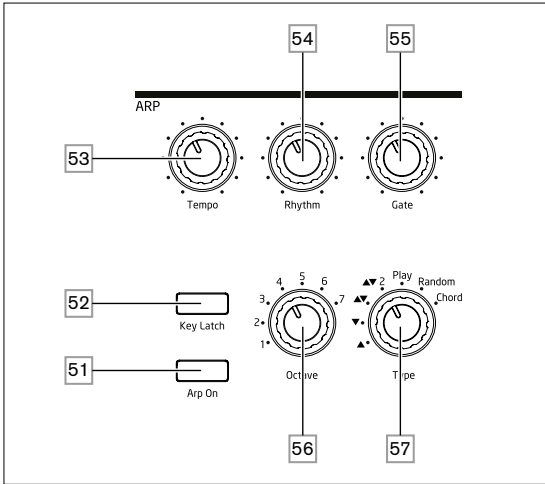

The primary controls for the Arpeggiator are on the panel: other, secondary arp parameters – including clock source, swing and sync rate – are set up in the **Arp/Clock** menu (see below). The Arpeggiator is enabled by pressing the **Arp On** button [51].

Tempo

The **Tempo** control [53] sets the basic rate of the arp sequence: the range is 40 to 240 BPM. If Summit is being synchronised to an external MIDI clock (see page 34), it will automatically detect the incoming tempo and disable the internal clock. The tempo of the arp sequence will then be determined by the external MIDI clock.

Note that **Tempo** sets the clock rate for all Summit's tempo-synchronised features: e.g., Delay Sync and LFO Rate Sync, as well as the Arpeggiator rate.

Tempo control is also available on Page 1 of the **Arp/Clock** menu as the **ClockRate** parameter.



If the external MIDI clock source is removed, the Arpeggiator will continue to "flywheel" at the last known tempo. However, if you now adjust Tempo, the internal clock will take over and override the flywheel rate.

Arp Mode

When enabled, the Arpeggiator will play all notes held down in a sequence which is determined by the setting of the **Type** control [57]. The options available are summarised in the table below. The third column of the table describes the nature of the sequence in each case.

TYPE	DESCRIPTION	COMMENTS
▲	Ascending	Sequence begins with lowest note played
▼	Descending	Sequence begins with highest note played
▲▼	Ascend/descend	Sequence alternates
▲▼2		As ▲▼, but lowest and highest notes are played twice
Play	Key order	Sequence comprises notes in the order in which they are played
Random	Random	The notes held are played in a continuously-varying random sequence
Chord	Chord	The notes making up the sequence are played simultaneously, as a chord

Type selection is also available on Page 2 of the **Arp/Clock** menu as the **Type** parameter.

Arp Rhythm

As well as being able to set the basic timing and mode of the arp sequence (with the **Type** control and the **SyncRate** parameter in the **Arp/Clock** menu), you can also introduce further rhythmic variations by adjusting the **Rhythm** control [57]. The Arpeggiator comes with 33 pre-defined arp sequences; use the **Rhythm** control to select one. In general terms, the sequences increase in rhythmic complexity as the numbers increase; Rhythm 1 is a series of consecutive crotchets, and higher-numbered rhythms introduce more complex patterns, shorter duration notes (semiquavers) and syncopation.



You should spend some time experimenting with different combinations of **Rhythm** and **Type**. Some patterns work better with certain choices of **Type**.

Rhythm pattern may also be selected on Page 2 of the **Arp/Clock** menu with the **Rhythm** parameter.

Octave range

The **Octave** control [56] allows upper octaves to be added to the arp sequence. Set to 1, the sequence will contain only the notes played. When set to 2, the sequence is played as previously, then immediately played again an octave higher. Higher values extend this process by adding additional higher octaves. Note that settings other than 1 have the effect of doubling, tripling, etc., the *length* of the sequence. The additional notes added duplicate the complete original sequence, but octave-shifted. Thus a four-note sequence played with **Octaves** set to 1 will consist of eight notes when **Octaves** is set to 2. The range available is from one to seven octaves.

Arp octave range may also be selected on Page 2 of the **Arp/Clock** menu as the **Octaves** parameter.

Note duration

The **Gate** control [55] sets the basic duration of the notes played by the Arpeggiator (though this will be further amended by the **Rhythm** control and the **SyncRate** menu setting). Gate length is a percentage of the step length so the time during which the gate is open depends on the master clock speed. The lower the parameter value, the shorter the duration of the note played. At its maximum value (127), one note in the sequence is immediately followed by the next without a gap. At a value of 63, the note duration is exactly half the beat interval (as set by the **Tempo** control), and each note is followed by a rest of equal length.

Key Latch

The **Key Latch** button [52] plays the currently selected arp sequence repeatedly without the keys being held. If further key(s) are pressed while the initial keys are being held down, the extra note(s) will be added to the sequence. If further keys are pressed after releasing all the notes, a new sequence consisting only of the new notes will be played.

Arp data transmission

Summit can transmit MIDI note data from the arpeggiator, and can also force the arpeggiator to play notes according to received MIDI note data. See page 42 for more information.

The Arp/Clock Menu

The following Arpeggiator settings are available in the **Arp/Clock** menu, which has four pages. Note that some of these settings duplicate physical controls in the panel **ARP** section.

Arp Menu Page 1:

```
CLOCK           1/4
ClockRate      120BPM ▶
Source         Auto
Status INT     120.00bpm
```

Tempo

Displayed as: ClockRate
Initial value: 120 BPM
Range of adjustment: 40 to 240 BPM

This parameter sets Summit's internal clock rate in BPM. It provides the clock for Summit's tempo-synchronised features: Arpeggiator, Delay Sync and LFO Rate Sync. This parameter duplicates the physical **Tempo** control [53].

Clock source

Displayed as:	Source
Initial value:	Auto
Range of adjustment:	Auto, Internal, Ext-Auto, MIDI, USB

Summit uses a master MIDI clock in order to set the tempo of the arpeggiator and to provide a time base for synchronisation to an overall tempo. This clock may be derived internally or provided by an external device able to transmit MIDI clock. The `Source` setting determines whether Summit's tempo-synchronised features (including the Arpeggiator) will follow the tempo of an external MIDI clock source or follow the tempo set by the `ClockRate` parameter. The options are:

- **Auto** – when no external MIDI clock source is present, Summit will default to the internal MIDI clock. Tempo will be set by the `ClockRate` parameter. If an external MIDI clock is present, Summit will synchronise to it.
- **Internal** – Summit will synchronise to the internal MIDI clock irrespective of what external MIDI clock sources may be present.
- **Ext-Auto** – this is an auto-detect mode whereby Summit will synchronise to any external MIDI clock source (via USB or MIDI connection). Until an external clock is detected, Summit will run at its internal clock rate. When an external clock is detected, Summit automatically synchronises to it. If external clock is subsequently lost (or stopped), Summit's tempo then "flywheels" to the last-known clock rate.
- **MIDI** – synchronisation will be to an external MIDI clock connected to the (DIN) MIDI input socket. If no clock is detected, the tempo "flywheels" to the last-known clock rate.
- **USB** – synchronisation to an external MIDI clock received via the USB connection. If no clock is detected, the tempo "flywheels" to the last-known clock rate.

When set to either of the external MIDI clock sources the tempo will be at the MIDI Clock rate received from the external source (e.g., a sequencer). Make sure the external sequencer is set to transmit MIDI Clock. If unsure of the procedure, consult the sequencer manual for details.

The fourth row of Page 1 confirms the current status of the clock source, including the precise BPM. This row is read-only.

Most sequencers do not transmit MIDI Clock while they are stopped. Synchronisation of Summit to MIDI Clock will only be possible while the sequencer is actually recording or playing. In the absence of an external clock, the tempo may flywheel and will assume the last known incoming MIDI Clock value. In this situation, the fourth row of the OLED will display `FLY`. (Note that Summit does NOT revert to the tempo set by the `ClockRate` parameter unless `Auto` is selected.)

Status

Row 4 of Page 1 confirms the current clock source and BPM in use. It is not user-selectable for adjustment.

- `Status` will show `INT` when Summit is running on its internal tempo clock. The tempo displayed will match that set by the `ClockRate` parameter in Row 2.
- `Status` will show `USB` when Summit receives a valid clock at the USB port (3) and `Source` is set to `Auto`, `Ext-Auto` or `USB`. The tempo displayed will be that of the incoming external clock.
- `Status` will show `MIDI` when Summit receives a valid clock at the **MIDI IN** (DIN) connector (4) and `Source` is set to `Auto`, `Ext-Auto` or `MIDI`. The tempo displayed will be that of the incoming external clock.

Arp Menu Page 2:

ARP		2/4
Type	Up	▶
Rhythm	1	
Octaves	1	

Arp Mode

Displayed as:	Type
Initial value:	Up
Range of adjustment:	See table in "Arp Mode" on page 33

This parameter duplicates the physical **Type** control [57].

Arp Rhythm

Displayed as:	Rhythm
Initial value:	1
Range of adjustment:	1 to 33

This parameter duplicates the physical **Rhythm** control [54].

Octave range

Displayed as:	Octaves
Initial value:	1
Range of adjustment:	1 to 6

This parameter duplicates the physical **Octave** control [54].

Arp Menu Page 3:

ARP		3/4
Swing	50	▶
SyncRate	16th	
KeySync	Off	

Swing

Displayed as:	Swing
Initial value:	50
Range of adjustment:	20 to 80

If `Swing` is set to something other than its default value of 50, some further interesting rhythmic effects can be obtained. Higher values lengthen the interval between odd and even notes, while the even-to-odd intervals are correspondingly shortened. Lower values have the opposite effect. This is an effect which is easier to experiment with than describe! Adding `Swing` is a great way to introduce a groove, or rhythmically swung musical feeling to your arp sequences.

Arp Rate Sync

Displayed as:	SyncRate
Initial value:	16th
Range of adjustment:	See table at page 45 for full details

This parameter effectively determines the beat of the arp sequence, based on the tempo rate set by the `ClockRate` parameter.

Arp Key Sync

Displayed as:	KeySync
Initial value:	Off
Range of adjustment:	Off or On

`KeySync` only applies when **Key Latch** [31] is On. It determines how the sequence behaves when a new set of notes is played. With `KeySync` off, the notes are changed but the constant rhythm dictated by the arp pattern is maintained. If `KeySync` is On, the arp pattern will be interrupted and immediately restarted as the keys are struck.

Arp Menu Page 4:

ARP		4/4
ArpVelMode	Rhythm	▶

Arp Velocity Mode

Displayed as:	ArpVelMode
Initial value:	Rhythm
Range of adjustment:	Rhythm or Played

Arp Velocity Mode sets the relative volume of the notes comprising the arp pattern. With the default setting of `Rhythm`, the pattern will be played with a predetermined volume for each note, regardless of how the keys making up the pattern were struck. For most of the patterns, this will mean all the notes will have the same volume. However, some of the more complex patterns already have velocity information associated with each step, so the notes making up the pattern may differ slightly in volume, as this is what was intended when the pattern was created.

If `ArpVelMode` is set to `Played`, the way each key is struck is taken into account and the velocity value of each is applied to the step. This results in an arp pattern that more closely replicates how the notes defining the pattern's content were played. In order for the `Played` mode to operate correctly, it is necessary to first assign a non-zero value to the Velocity parameter on Page 1 of the **Env** menu (see page 30). Alternatively, assign Velocity as a source in the Mod Matrix to control another synth parameter, such as Filter Frequency.

The Effects Section

Summit comes equipped with two sound effects (FX) sections – one per Part. FX can be applied to the sound the synth is generating to add colour and character. When Multi Patches are in use, FX may be added to Parts A and B independently. All FX parameters are saved with the Patch.

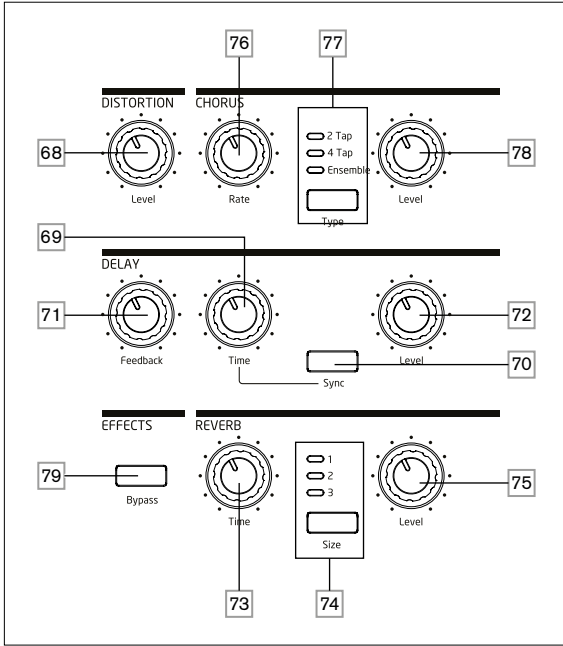

The FX tools comprise analogue distortion and three digital “time-domain” effects: Reverb, Chorus and Delay. Each effect has its own set of controls and you can use any or all FX without restriction.

In addition, the **FX Menu** provides extensive control of additional parameters for the digital FX. These may be used in parallel configuration, or arranged in series in any order: the configurations are set up in the **FX Menu**.

A second menu – **FX Mod** – gives access to a 4-slot modulation matrix dedicated to the FX section. This is entirely independent of the main modulation Matrix (accessed through its own **Mod** menu), and allows you to apply modulation control to most primary FX parameters. See page 39 for full details.

The FX processing section is active by default: the Bypass button [79] switches the digital FX processing out of circuit: it does not bypass the Distortion processor.

Distortion

Distortion may be added with the single **Level** control [68]. A controlled amount of distortion is added after the VCA, in the analogue domain, and affects the sum of all sixteen voices and any external audio inputs applied. (See the block diagram at page 21.) This means the distortion characteristic will change as the amplitude of the signal changes over time as a result of the Amplitude Envelope, and also with the number of active voices.

The output from the Distortion processor is then routed to the other FX.

Note that “per-voice” distortion may be added either post-filter by adjusting **Post Filter Drive** on Page 3 of the **Voice** menu, or pre-filter by adjusting the **Overdrive** control in the Filter section [62].

Chorus

Chorus is an effect produced by mixing a continuously delayed version of the signal with the original. The characteristic swirling effect is produced by the Chorus processor’s own LFO making small changes in the delays. The changing delay also produces the effect of multiple voices, some of which are pitch-shifted; this adds to the effect.

Summit has three stereo Chorus programs, named **2 Tap**, **4 Tap** and **Ensemble**, selected by the **Type** button [77]. The names reflect the nature of traditional chorus generation, which was to mix together several versions of the same signal, each with a different and varying delay, derived from a multi-tap delay line. The amount of Chorus effect added to the “dry” signal is adjusted by the **Level** control [78]. The **Rate** control [76] sets the frequency of the Chorus processor’s dedicated LFO. Lower values give a lower frequency, and hence a sound whose characteristic changes more gradually. A slow rate is often more effective.

There are further Chorus parameters available for adjustment in the **FX Menu**.

Delay

The Delay FX processor produces one or more repetitions of the note played. Although the two are intimately related in an acoustic sense, delay should not be confused with reverb in terms of an effect. Think of delay simply as “Echo”.

The **Time** control [69] sets the basic delay: the note played will be repeated after a fixed time. Higher values correspond to a longer delay. If Time is varied while a note is being played, pitch shifting will result.

It is often desirable to synchronise echoes to tempo: on Summit this can be done by selecting **Sync** [70]. The **Time** control then invokes Page 4 of the **FX** menu, and varies the **DELAYSYNC** parameter, which is displayed on the OLED while the control is adjusted. The sync value is limited by the maximum delay time of 1.4 seconds, consequently some combinations of **ClockRate** (set on Page 1 of the **Arp/Clock** menu) and **DELAYSYNC** result in truncating the delay time to the maximum calculated sync rate permissible, i.e., the delay time will reduce, but it will remain in sync.

The output of the delay processor is connected back to the input, at a reduced level; The **Feedback** control [71] sets the level. This results in multiple echoes, as the delayed signal is further repeated. With **Feedback** set to zero, no delayed signal at all is fed back, so only a single echo results. As you increase the value, you will hear more echoes for each note, though they still die away in volume. Setting the control in the centre of its range (64) results in about 5 or 6 audible echoes; at the maximum setting the decay in volume is almost imperceptible and the repetitions will still be audible after a minute or more.

The **Level** control [72] adjusts the level of the echoes: at the maximum setting (127), the first echo is approximately the same volume as the initial, dry note.

There are further Delay parameters available for adjustment in the **FX Menu**.

Reverb

Reverberation (reverb) adds the effect of an acoustic space to a sound. Unlike delay, reverb is created by generating a dense set of delayed signals, typically with different phase relationships and equalisations applied to re-create what happens to sound in a real acoustic space.

Summit provides three reverb presets, selected by the **Size** button [74]. The presets are simply numbered **1**, **2** and **3**, and set the **ReverbSize** parameter (see page 37) to values of 0, 64 or 127 respectively, thus simulating spaces of different sizes.

The **Time** control [73] sets the basic reverb time of the selected space and determines how long it takes the reverb to die away to inaudibility. The **Level** control [75] adjusts the volume of the reverb.

The FX Menu

The following additional parameters for the three time-domain effects are available in the **FX** menu. Two menu pages are dedicated to Chorus (Pages 2 and 3) and two to Delay (Pages 4 and 5); Reverb has three pages (Pages 6 to 8). There is one further page (Page 1) with “global” parameters affecting all three effects.

Global FX page:

The default menu display is shown below:

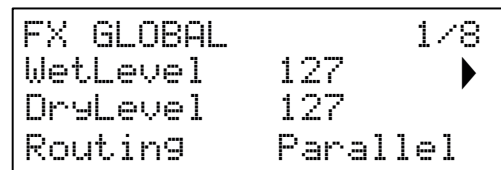

The parameters available on the Global FX page affect all three time-domain FX processors (Chorus, Delay and Reverb).

Wet and Dry Levels

Displayed as:	WetLevel	DryLevel
Initial value:	64	and 127
Range of adjustment:	0 to 127	0 to 127

The inclusion of the “Wet” and “Dry” parameters are used here to assist with importing patches from our Peak synthesizer. They have no effect on the engine of Summit.

If you wish to have a different level for the effects compared to the dry level you can send the FX to a separate output to the Synth engine by adjusting the setting on page 13 of the **Settings** menu. (See page 43).

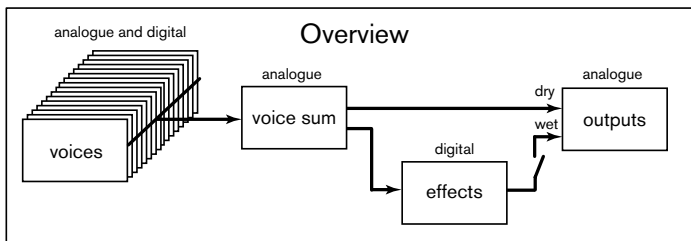

FX Routing

Displayed as: Routing
 Initial value: Parallel
 Range of adjustment: Parallel, D->R->C, D->C->R, R->D->C, R->C->D, C->D->R, C->R->D

When using more than one of the three time-domain effects (Chorus = C, Delay = D and Reverb = R) simultaneously, the overall effect will differ depending on the order of processing. For example, if Delay precedes Reverb, each echo added to notes by the Delay processor will initiate its own reverberation. If Delay follows Reverb, the Delay processor will attempt to generate a multiplicity of fresh reverberations as repeats. Routing allows you to arrange the three time-domain processors in series in any order, or to configure them to process sounds in parallel, i.e., simultaneously, with the outputs being blended together. In parallel (the default configuration), the overall result is subtly different from any of the series configurations.

Chorus pages:

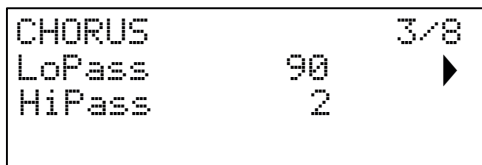
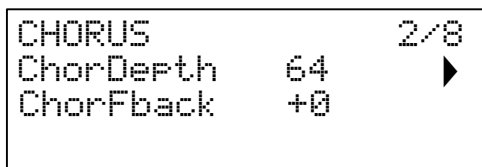

Chorus Depth

Displayed as: ChorDepth
 Initial value: 64
 Range of adjustment: 0 to 127

The ChorDepth parameter determines the amount of LFO modulation applied to the Chorus delay time, and thus the overall depth of the effect. A value of zero results in no chorus effect being added.

Chorus Feedback

Displayed as: ChorFback
 Initial value: 0
 Range of adjustment: -64 to +63

The Chorus processor has its own feedback path between output and input, and a degree of feedback can be applied to get a more effective sound. Negative values of the ChorFback parameter mean the signal being fed back is phase-reversed: High values – positive or negative – can add a dramatic "swooping" effect. Adding feedback and keeping the value of ChorDepth low will turn the Chorus FX into a flanger.

Chorus HF EQ

Displayed as: LoPass
 Initial value: 90
 Range of adjustment: 0 to 127

The LoPass parameter adjusts a simple HF filter within the chorus processor. Adjusting this will enhance or mask some of the additional higher harmonics added to the sound by the Chorus effect. When LoPass is set to its maximum value of 127, the filter is fully open.

Chorus HF EQ

Displayed as: HiPass
 Initial value: 2
 Range of adjustment: 0 to 127

The HiPass parameter adjusts a simple LF filter within the chorus processor, letting you refine the Chorus effect further. With HiPass set to zero, the filter is fully open.

Delay pages:

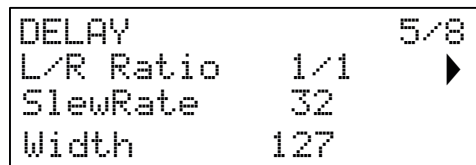
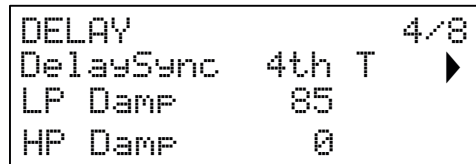

Delay Sync

Displayed as: DelaySync
 Initial value: 4th T
 Range of adjustment: See table at page 36 for full details

Delay time may be synchronised to the internal or external MIDI clock, using a wide variety of tempo dividers/multipliers to produce delays from about 5 ms to 1 second.

The value of DelaySync is also displayed while the front panel Time control [69] is being adjusted, when Sync [70] is set On.



Be aware that the total delay time available is finite. Using large tempo divisions at a very slow tempo rate may exceed the maximum delay time available.

HF Damping

Displayed as: LP Damp
 Initial value: 85
 Range of adjustment: 0 to 127

Echoes produced acoustically by reflections in physical spaces decay at different rates at different frequencies, depending on the type of surface producing the reflection. The two Damping parameters LP Damp and HP Damp allow a simulation of this effect. LP Damp (Lo-pass Damping) is a filter which can be used to reduce the brightness of later echoes: with the parameter set to its maximum value of 127, the filter is fully open.

Note that the varying damping only applies to the delayed notes, not to the initial one. See also the Damping parameters in the Reverb processor.

LF Damping

Displayed as: HP Damp
 Initial value: 0
 Range of adjustment: 0 to 127

This has a similar effect to LP Damp, but is a hi-pass filter. When the parameter is set to zero, the filter is fully open: as the value is increased, later echoes will be progressively reduced in LF content.

As with LP Damp, the varying damping only applies to the delayed notes, not to the initial one. See also the Damping parameters in the Reverb processor.

Left-Right Ratio

Displayed as: LR Ratio
 Initial value: 1/1
 Range of adjustment: 1/1, 4/3, 3/4, 3/2, 2/3, 2/1, 1/2, 3/1, 1/3, 4/1, 1/4

The value of this parameter is a ratio, and determines how each delayed note is distributed between the left and right outputs. Setting LR Ratio to the default 1/1 value places all echoes centrally in the stereo image. With other values, echoes are alternated rhythmically between left and right at simple ratios of the delay time: settings of 1/2 or 2/1 produces the familiar "ping-pong" effect of equally spaced echoes alternating between left and right.

Delay Slew Rate

Displayed as: SlewRate
 Initial value: 32
 Range of adjustment: 0 to 127

The value of `SlewRate` affects the nature of the sound while the Delay Time is being varied. Varying delay time produces pitch-shifting. With `SlewRate` set to the maximum value (127), almost no pitch-shift effects will be heard as the **Time** control [44] is adjusted. With lower values, the pitch-shift effects become more evident. As the purpose of varying delay time in performance is generally to produce pitch shift artefacts, a medium value is usually desirable.

Width

Displayed as: Width
 Initial value: 127
 Range of adjustment: 0 to 127

The `Width` parameter is only relevant to settings of LR Ratio which result in the echoes being split across the stereo image. With its default value of 127, any stereo placement of delayed signals will be fully left and fully right. Decreasing the value of `Width` reduces the width of the stereo image and panned echoes tend towards the centre position.

Reverb pages:

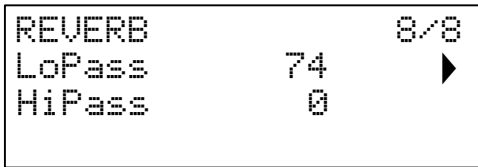
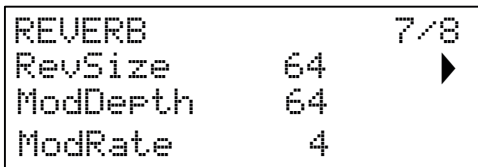
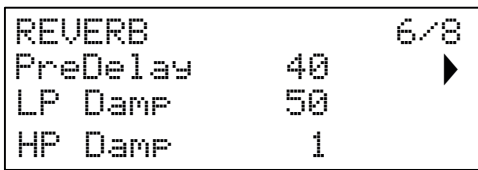

PreDelay

Displayed as: PreDelay
 Initial value: 40
 Range of adjustment: 1 to 127

In a very large space, the first reflections making up the reverberation are not heard immediately. `PreDelay` controls how soon after the start of the initial note the reverberation begins, and thus allows a more accurate simulation of a real space to be created. With `PreDelay` set to its maximum value (127), the first reflections are delayed by approximately half a second.

HF Damping

Displayed as: LP Damp
 Initial value: 50
 Range of adjustment: 0 to 127

This parameter performs the same function for the reverb processor as the corresponding one in the Delay processor, in that it simulates the effect of high-frequency absorption by different surfaces. The low-pass filter used to create this effect is fully open when `LP Damp` is set to its maximum value of 127.

LF Damping

Displayed as: HP Damp
 Initial value: 1
 Range of adjustment: 0 to 127

This parameter performs the same function for the reverb processor as the corresponding one in the Delay processor, in that it simulates the effect of low-frequency absorption by different surfaces. The high-pass filter used to create this effect is fully open when `HP Damp` has a value of zero.

Size

Displayed as: RevSize
 Initial value: 64
 Range of adjustment: 0 to 127

The `RevSize` parameter alters the reverberation character: larger values introduce additional and more prominent reflections, simulating the effect of a larger physical space. Note that the **Size** button [74] sets `RevSize` to 0, 64 or 127, so the menu option allows finer adjustment between these values.

Reverb Modulation

Displayed as: ModDepth and ModRate
 Initial value: 64 and 4
 Range of adjustment: 0 to 127

The reverb processor includes a dedicated modulation source, which can be used to alter the reverb time (set with the **Time** control [73]). Two parameters are provided: `ModDepth`, which controls the degree of modulation and `ModRate`, which controls the modulation rate.

Reverb HF EQ

Displayed as: LoPass
 Initial value: 74
 Range of adjustment: 0 to 127

This parameter controls a simple low-pass filter, constituting an HF EQ section affecting the reverberation itself. The effect differs the `LoPass Damping` parameter: `LoPass` is a simple filter for the overall reverberation (not the initial note) while `LP Damp` is a coefficient defining how the reverb algorithm itself operates on high frequencies. The filter is fully open when the parameter has its maximum value of 127.

Reverb LF EQ

Displayed as: HiPass
 Initial value: 0
 Range of adjustment: 0 to 127

`HiPass` is the parameter controlling a corresponding high-pass filter affecting the low-frequency content of the reverberation. The filter is fully open when the parameter is zero.

The Modulation Matrix

The power of a versatile synthesiser lies in its ability to interconnect the various controllers, sound generators and processing blocks such that one block is controlling – or “modulating” – another, in as many ways as possible. Summit provides considerable flexibility of control routing, and there is a dedicated menu for this, the **Mod** Menu. As with every other aspect of Summit, the Modulation Matrix routings for each of the two synths generating Parts A and B may be configured independently by selecting **A** or **B** in **MULTIPART CONTROL** when using a Multi Patch.

The available modulating sources and destinations to be modulated can be thought of as the inputs and outputs of a large matrix:

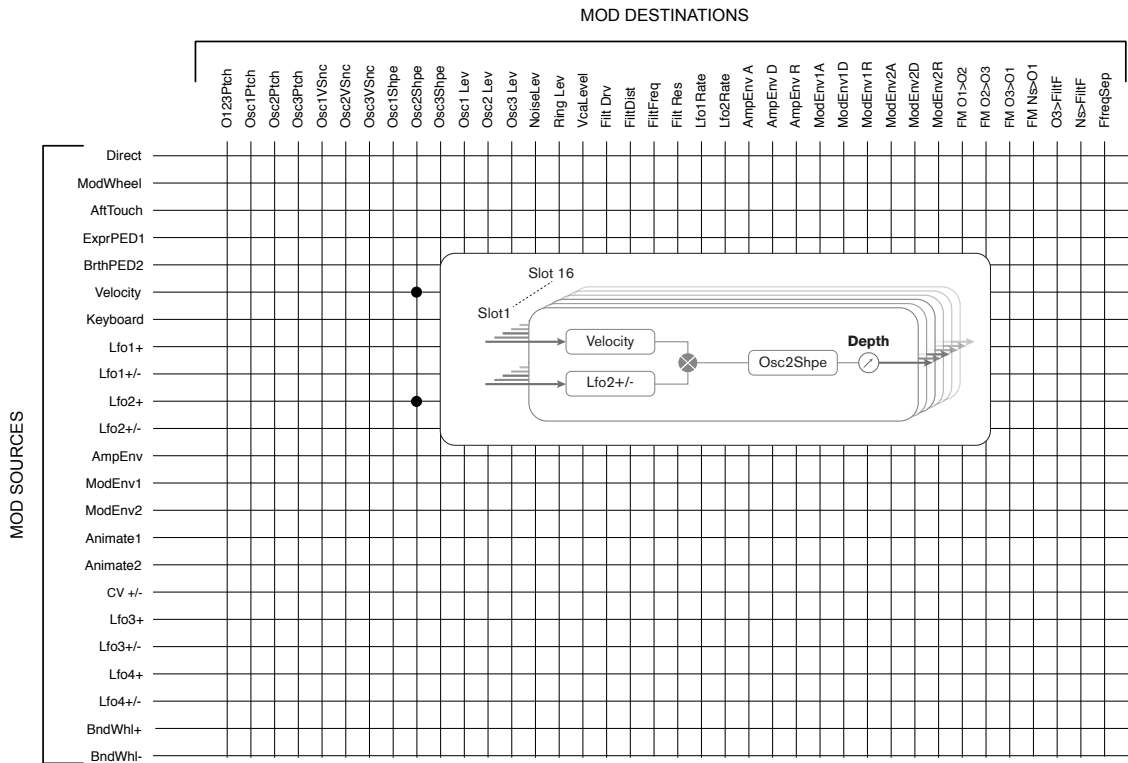

The example here shows how any two sources, in this case Velocity and LFO 2, can simultaneously modulate the same parameter, in this case Osc 2 Shape. Many mod matrix assignments will only use a single source. Note that the two modulation sources are effectively multiplied together, and the **Depth** parameter controls the overall degree of modulation. The diagram depicts a single matrix “slot”: each of the two Summit synths has 16 such slots, allowing an enormous range of modulation possibilities.

Press the **Mod** button **[9]** to open the Modulation Menu, which comprises 16 pages, one for each slot. Select a slot with the **Page** **◀** and **Page** **▶** buttons. The page lets you define which (one or two) modulation sources are to control – i.e., modulate - a ‘destination’ parameter. The routing possibilities available in each slot are identical, and hence the control description below is applicable to all 16 slots.

The default menu display for Slot 1 is shown below:

```

:sA [Slot 1] sB:
:▶Direct : Direct
Destin 0123Ptch
Depth +0
    
```



The Modulation Matrix is both variable and additive. What do we mean by ‘variable’ and ‘additive’ as applied to a matrix?

By ‘variable’, we mean that it is not just the routing of a controlling source to a controlled parameter which is defined in each slot, but also the “magnitude” of the control. Thus the ‘amount’ of control – or Depth – used is up to you.

By ‘additive’ we mean a parameter may be varied by more than one source. Each slot allows for two sources to be routed to a parameter, and their effects are multiplied together. This means if either of them is at zero, there will be no modulation. However, there is no reason why you can’t have further slots routing these or other sources to the same parameter. In this case, the control signals from different slots “add” to produce the overall effect.

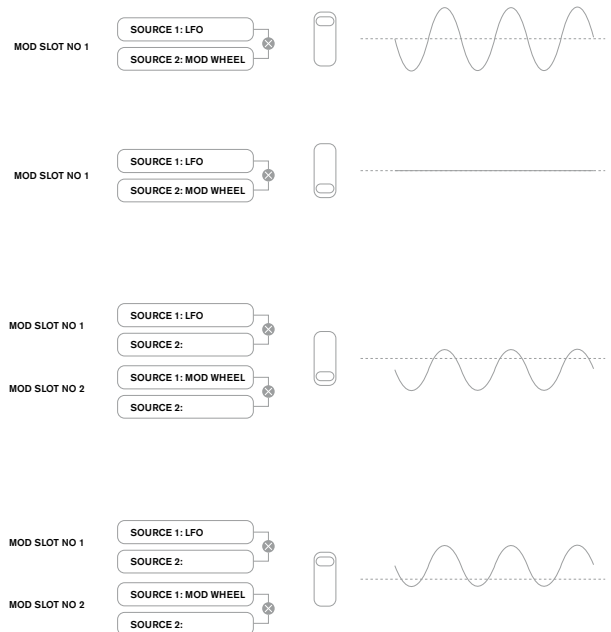



You need to be careful when setting up patches like this to ensure that the combined effect of all the controllers acting simultaneously still creates the sound that you want.

In addition, the Modulation Menu lets you assign the two **ANIMATE** buttons as sources (see page 15).

NOTE: The FX Modulation Matrix Menu

In addition to the sources and destinations available in the main Modulation Matrix, four additional matrix routing slots specifically dedicated to the FX section are available in the **FX Mod** Menu. These allow most Modulation Matrix sources to directly modulate FX parameters. See page 39 for full details.

Each slot has two inputs, A and B, which allows each destination parameter to be modulated by two different sources. The three buttons to the left of the OLED display select Rows 2, 3 or 4 for adjustment, but note that the Row 2 button toggles source selection between slot inputs A and B. Source A is displayed on the left of Row 2 and Source B on the right: in the default display shown above, both are set to **Direct** (no modulation selected).

Use the **Page** (and **Page**) buttons to select one of 16 slots. All the slots have the same selection of sources and destinations and any or all can be used. The same source can control multiple destinations in different slots, and similarly, one destination can be controlled by multiple sources by using several slots.

Modulation Source

Displayed as: `!sA [Slot n] sB!` (where n= slot number; the two sources are displayed on Row 2)
 Initial value: **Direct** (both A and B sources)
 Range of adjustment: see table at page 46 for list of available sources

This lets you select a control source (modulator), which will be routed to the synth element selected by **Destination** (see below). Setting both **sA** and **sB** to **Direct** means when the Depth for the Slot is set to a non-zero value, a fixed change will be applied to the value of the selected destination parameter (i.e., there is no time-varying modulation).

Note that the list of sources includes Expression pedals. If you connect an Expression pedal to either of the rear panel pedal connectors, they can be selected to control any destination you wish in the normal way. If you wish an Expression pedal to control overall synth volume in a natural way, choose **Volume** as the routing destination for **sA** and **Amplify** for **sB**.

The CV input is also available as a source for the Mod Matrix. The CV input can be routed to any of the available mod destinations. The CV input has been designed to respond to control inputs without aliasing up to just over 1 kHz (which roughly corresponds to two octaves above middle C).



The Modulation Matrix **Aftertouch** source will accept either channel aftertouch, either from Summit's own keyboard or as external MIDI data. This is the most common type of aftertouch. Summit will also accept polyphonic aftertouch, which is generated by some controllers such as the Novation LaunchPad Pro. When polyphonic aftertouch is received, the pressure applied during a note event is interpreted as a modulation event for this one note only. This provides a level of expressivity in playing that is uncommon with hardware synths.

Modulation Destination

Displayed as: **Destin**
 Initial value: **O123Ptch**
 Range of adjustment: see table on page 46 for available destinations list

This sets the parameter to be controlled by the selected source (or sources) in the currently selected slot. The range of possibilities includes:

parameters that directly affect the sound:

- three parameters per oscillator (Pitch, Vsync and Shape)
- global pitch (O123Ptch)
- the five mixer inputs from the oscillators, noise source, ring modulator and the mixer output (see Tip below)
- Filter frequency, resonance and distortion

parameters that can also act as modulating sources (thus permitting recursive modulation):

- LFO 1 & 2 frequency
- the Attack, Decay and Release phases of all three Envelopes
- Frequency Modulation of oscillators (FM) by filter other oscillators or Noise



The mixer output (VCA level) is an unusual matrix destination! The VCA is the main output stage for the synth and this is normally under the sole control of the Amplitude Envelope, but Summit lets you assign the VCA as a destination in the Mod Matrix. If either Source A or Source B is not set to an Envelope, the VCA can be controlled independently of any notes being played.

Modulation Depth

Displayed as: **Depth**
 Initial value: **0**
 Range of adjustment: **-64 to +63**

The **Depth** parameter sets "how much" control is being applied to the Destination – i.e., the parameter being modulated by the selected source(s). If both Source A and Source B are active in the slot in question, **Depth** controls their combined effect.



Depth effectively defines the "amount" by which the controlled parameter varies when under modulation control. Think of it as the "range" of control. It also determines the "sense" or polarity of the control – positive values of **Depth** will increase the value of the controlled parameter and negative values will decrease it, for the same control input. Note that having defined source and destination in a patch, no modulation will occur until the Depth control is set to something other than zero.

Negative values of **Depth** do not work on certain parameters, unless modulation is already being applied to that parameter by some other routing, in which case the negative sense "cancels" the modulation already present. Examples are: i) Oscillator Vsync – needs to be applied via the Oscillator Menu before it can be reduced by a Mod Matrix routing; ii) FM of one oscillator by another – another mod slot must already be applying the FM before it can be cancelled.



With both sources set to **Direct**, the parameter control (Depth) becomes a "manual" modulation control which will always affect whichever parameter is set as the Destination, by a fixed amount proportional to the value of Depth.

The FX Modulation Matrix

Pressing **FX Mod** 9 opens the FX Mod Matrix menu. The FX Modulation Matrix is effectively an extension of Summit's main Modulation Matrix, but is devoted solely to using various internal Summit sources to modulate FX parameters. It has four "slots" each with two inputs, so you can simultaneously modulate up to four different FX parameters from up to eight separate sources. It is set up in the same manner as the main Modulation Matrix. The four pages are identical, and each allows one slot to be configured.

The default menu display for Slot 1 is shown below:

```
!sA [FxSlot 1] sB!
:Direct : Direct
Fx Destin Dist Lev
Depth +0
```

As with the main Modulation Matrix, each slot has two inputs, A and B, which allows each destination FX parameter to be modulated by two different sources. The three buttons to the left of the OLED display select Rows 2, 3 or 4 for adjustment, but note that the Row 2 button toggles source selection between slot inputs A and B. Source A is displayed on the left of Row 2 and Source B on the right: in the default display shown above, both are set to **Direct** (no modulation selected).

System pages:

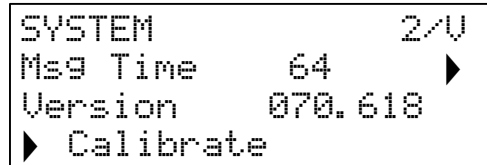
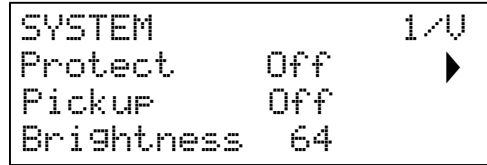

Patch Memory Protection

Displayed as: Protect
 Initial value: Off
 Range of adjustment: On or Off

Setting **Protect** to On disables Summit's Patch Save function: subsequently, pressing **Save** will generate the display message below:

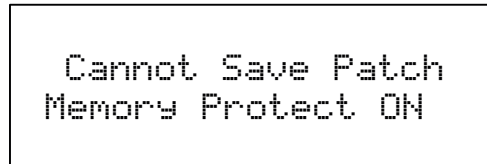

This is a useful function if you need to be sure Patches already saved (including factory Patches) cannot be overwritten.

If **Protect** is Off, pressing **Save** will store all the current synth settings, including those of the **Settings** menu. The message below will be displayed:

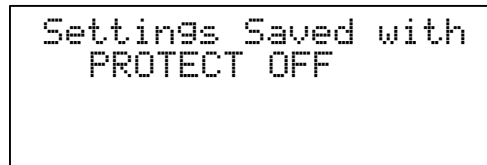

Pickup

Displayed as: Pickup
 Initial value: Off
 Range of adjustment: On or Off

The setting of **Pickup** allows the current physical position of Summit's rotary controls to be taken into account. When **Pickup** is Off, adjusting any of Summit's rotary controls will produce parameter change and a potentially immediately audible effect (a small difference between the parameter value corresponding to the control's physical position and the value currently in force for the Patch may result in the effect being inaudible). When set to On, the control needs to be moved to the physical position corresponding to the value of the parameter saved for the currently loaded Patch, and will only alter the parameter value once that position is reached. For parameters with a range of 0 to 255, this means the 12 o'clock position will correspond to a value of 127; for parameters with a range of -64 to +63, the 12 o'clock position will correspond to a value of zero.

Brightness

Displayed as: Brightness
 Initial value: 64
 Range of adjustment: 0 to 127

Adjusts the brightness of the OLED display.

FX MOD DESTINATIONS

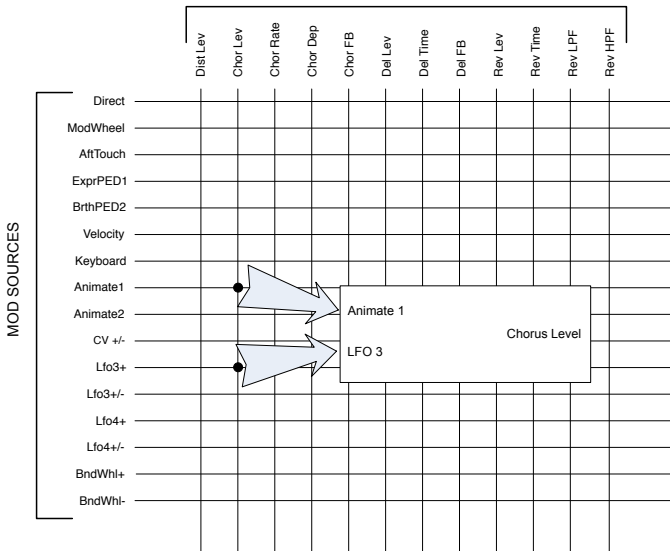

FX Modulation Source

Displayed as: %sA and %sB
 Initial value: Direct
 Range of adjustment: see table at page 46 for list of available sources

FX Modulation Destination

Displayed as: FX Destin
 Initial value: Dist Lev
 Range of adjustment: see table at page 46 for list of available destinations

FX Modulation Depth

Displayed as: Depth
 Initial value: 0
 Range of adjustment: 64 to +63

The Depth parameter sets "how much" control is being applied to the Destination – i.e., the parameter being modulated by the selected source(s). If both Source A and Source B are active in the slot in question, Depth controls their combined effect. If no sources selected, the **Depth** control can be used to adjust the "amount" of the destination parameter. Setting a negative value of **Depth** has the effect of reducing the effect of the destination parameter as set by its own control or menu option.

The Settings Menu

Press the **Settings** button [9] to open the **Settings** Menu. This menu has 31 pages, numbered from 1 to 9, then from A to V. It contains a set of synth and system functions which, once set up, will not need to be accessed on a regular basis. The **Settings** Menu includes global synth settings, Patch backup routines, MIDI and pedal settings, I/O routings and the 16 user-definable Oscillator Tuning Tables, among other functions.

The **Settings** Menu defines settings which are global for the synth, and are not saved with individual Patches. However, it is possible to keep the current contents of the **Settings** menu by opening **Settings** and pressing **Save** [11]. This ensures the settings (such as Tuning Tables, **WAVE** and Patch Memory Protection) are kept after power-cycling.

Saving Settings as described above will also save the current Patch, with all its current parameter values as a default, and this Patch will be re-loaded at the next power-cycle.

Message Time

Displayed as: Msg Time
 Initial value: 64
 Range of adjustment: 0 to 127

Msg Time sets the time for which parameter values (and the saved value for the current Patch) are displayed when a rotary control is adjusted. The maximum time (value of 127) is equivalent to approx. 3 seconds.

OS version

Displayed as: Version

This is read-only data, and reports Summit's OS (Operating System) version. This lets you ensure you have the most up-to-date OS installed.

Auto Calibration

Displayed as: Calibrate

Pressing the Row 4 button initiates a calibration routine which sets up the filters, VCAs and distortion circuitry accurately. This will have been done at the factory and should not need to be run again, but the routine has been included for good measure. The procedure takes several minutes, and the synth should not be touched while in progress. Note that the routine overrides the master volume control and sets it to maximum.

WARNING: The test generates various tones which will be present at the synth's outputs; we recommend you mute or turn off any external amplifier or loudspeakers connected as these will be at full volume.

When the calibration routine is complete, the display shows:

```
Calibration Complete
Re-Power Now
```

Synth page:

```
SYNTH 3/U
VelShape 64
TuneCents +0
Transpose +0
```

Key Response

Displayed as: VelShape
 Initial value: 64
 Range of adjustment: 0 to 127

This parameter modifies the synth's response to the velocity curve set on the keyboard. The default value of 64 results in a linear relationship between the velocity curve and the synth's response. Reducing the value will result in lighter key touches producing a greater volume; a higher value results in the opposite. You can set the VelShape parameter to suit your normal playing style.

Master Fine Tuning

Displayed as: TuneCents
 Initial value: 0
 Range of adjustment: -50 to +50

This control adjusts the frequencies of all the Oscillators by the same small amount, allowing you to fine-tune the whole synth to another instrument if necessary. The increments are cents (1/100 of a semitone), and thus setting the value to 50 tunes the synth to a quarter-tone midway between two semitones. A setting of zero tunes keyboard with the A above middle C at 440 Hz - i.e., standard Concert Pitch.

Transpose

Displayed as: Transpose
 Initial value: +0
 Range of adjustment: -12 to +12

Transpose is a useful global setting which "shifts" Summit's keyboard up or down one semitone at a time. It also applies the same "shift" to received MIDI Note data, so if you are playing Summit from a master MIDI keyboard or controlling it from a sequencer, you can still use transposition. Transpose differs from oscillator tuning in that it modifies the control data from the keyboard rather than the actual oscillators. Thus setting Transpose to +4 means you can play with other instruments in the actual key of E major, but only need to play white notes, as if you were playing in C major.

Note Transpose does not affect Note data generated by the arpeggiator.

MIDI pages:

```
MIDI CHANNEL 4/U
PartA Chan 2
PartB Chan 3
Globl Chan 1
```

```
MIDI CONTROL 5/U
Local On
Arpeg>MIDI On
```

```
MIDI ENABLE 6/U
CC/NRPN Rec+Tran
Bank/Patch Rec+Tran
```

MIDI protocol provides for 16 channels of data. This allows up to 16 devices to co-exist on a MIDI network, provided each is assigned to operate on a different MIDI channel.

Assign MIDI Channels - Part A

Displayed as: PartA Chan
 Initial value: 2
 Range of adjustment: 1 to 16

Summit's bi-timbral architecture effectively means it comprises two independent synthesisers, one for each Part. When working with Multi Patches, you can configure it to receive and transmit MIDI data for each of the two Parts on separate channels, for the greatest flexibility of interfacing with external equipment.

PartA Chan lets you select which MIDI channel is to be used for MIDI data relating to Part A.

No data is transmitted or received on the Single MIDI channels when Summit is in Multi Patch mode. How Summit handles MIDI data in and out in Multi Patch mode is further modified by the **MULTI MODE** in use. See page 46 for more details.

Assign MIDI Channels - Part B

Displayed as: PartB Chan
 Initial value: 3
 Range of adjustment: 1 to 16

PartB Chan lets you select which MIDI channel is to be used for MIDI data relating to Part B. In all other respects, it operates described for as PartA Chan above.

Assign MIDI Channels (Global)

Displayed as: Globl Chan
 Initial value: 3
 Range of adjustment: 1 to 16

The Global MIDI channel should be used in Single Patch mode. No data is transmitted on the Global MIDI channel when Summit is in Multi Patch mode.

Local Control On/Off

Displayed as:	Local
Initial value:	On
Range of adjustment:	Off or On

In normal operation (with Local set to On), all of Summit's physical controls are active, and also transmit their settings as MIDI data, provided CC/NRPN on **Settings Menu Page 6** is set to either Transmit or Rec+Tran (see MIDI Control data setting below). With **Local** set to Off, the physical controls no longer vary any internal Summit parameters, but still output their values as MIDI data in the same way.

Arp MIDI mode

Displayed as:	Arp>Midi
Initial value:	On
Range of adjustment:	Off or On

This setting determines how the arpeggiator handles MIDI data.

- Off: the arp responds to incoming MIDI note data, either via the MIDI IN DIN port or the USB port. Control data is transmitted from both the MIDI OUT and USB ports. If the note data is received at the MIDI IN port, it is also retransmitted to MIDI THRU.
- On: In this setting, the arp responds to received MIDI note data in the same manner, but additionally transmits arpeggiator note data via both the MIDI OUT and USB ports, along with control data.

MIDI control data

Displayed as:	CC/NRPN
Initial value:	Rec+Tran
Range of adjustment:	Disabled, Receive, Transmit, Rec+Tran

With the default CC/NRPN setting of Rec+Tran, Summit's physical controls transmit their settings as MIDI CC or NRPN data (see table at page 47). Summit also responds to received MIDI CC/NRPN data with this setting. You can choose to only transmit MIDI data and not receive it (Transmit), or to receive it but not transmit (Receive). The fourth option, Disabled, effectively isolates Summit from any other MIDI equipment to which it is connected. See also Local Control On/Off above. Note CC/NRPN messages do not include Patch data, which is handled separately as Program Change messages – see Bank/Patch below.

Patch Select via MIDI

Displayed as:	Bank/Patch
Initial value:	Rec+Tran
Range of adjustment:	Disabled, Receive, Transmit, Rec+Tran

This setting controls how Summit handles MIDI Program Change and Bank Change messages. With the default setting of Rec+Tran, Summit sends a Program/Bank Change message whenever a new Patch is loaded, and will also load a Patch when told to by an external MIDI controller, such as the Novation SL MkIII. As with MIDI control data (above), you can choose to set Receive or Disabled, so Summit does not transmit Program/Bank Change messages when you change Patches, or to set Transmit or Disabled, so Summit does not respond to Program/Bank Change messages from external equipment.



If you find that your other MIDI synthesisers are changing their sound when you change a Patch in Summit, they are probably reacting to Program Change messages transmitted by Summit. If this is undesirable set Bank/Patch on Summit to either Disabled or Receive.

Pedal pages:

```
PEDAL SW SENSE 7/V
Ped1Sense Auto
Ped2Sense Auto
```

```
PEDAL SW MODE 8/V
Ped1Mode Animate1
Ped2Mode Animate2
```

These two menu pages are concerned only with pedals of the switch (on/off) type. If you are using one or more Expression pedals, these may be connected to either or both of the two **PEDAL** sockets on the rear of the synth. There are no Settings Menu options for Expression pedals: they are assigned in the Mod Matrix on a per-Patch basis.

Pedal Types

Displayed as:	Ped1Sense		Ped2Sense
Initial value:	Auto	and	Auto
Range of adjustment:	Auto, N/Open, N/Closed		Auto, N/Open, N/Closed

Summit supports two foot switch pedals of various types. A sustain pedal or footswitch can be connected to Summit via the **PEDAL 1** or **PEDAL 2** sockets (5). Ascertain whether your sustain pedal is of the normally-open or normally-closed type, and set the Ped1Sense or Ped2Sense parameter to suit. If you are unsure which it is, connect the footswitch with Summit unpowered, and then power it on (without your foot on the pedal!) Provided the default value of Auto is still set, the polarity will be correctly sensed.

Pedal Modes

Displayed as:	Ped1Mode		Ped2Mode
Initial value:	Animate1	and	Animate2
Range of adjustment:	Animate1, Sustain, Sostnuto		Animate1, Sustain, Sostnuto

The Pedal Mode settings determine what you want the switch pedals to do. The two pedals can act as foot switches for Summit's Animate functions: in this case, pressing a pedal triggers the Animate effect that has been defined within the Patch. You can alternatively assign either pedal to be a Sustain or a Sostenuato pedal (like the middle pedal on a three-pedal piano). When set to Sostenuato, notes played while the pedal is being pressed will be sustained. Once the pedal has been depressed, any further notes will not be sustained. This is useful for playing melodies over a held chord.

Misc Settings page

```
MISC SETTINGS 9/V
VolRange 0dB
InputGain 64
Initialise IniPatch
```

Volume Range

Displayed as:	VolRange
Initial value:	0 dB
Range of adjustment:	-6 dB, -3 dB, 0 dB

This global parameter is effectively a 3 or 6 dB pad (or level reduction) in the main audio outputs. It is useful when the equipment Summit's outputs are connected to have a restricted range of input level and you need to limit the maximum level Summit can output.

External Input Gain

Displayed as:	InputGain
Default value:	64
Range of adjustment:	0 to 127

This parameter is an input level adjustment for Summit's external line level inputs (10). These audio inputs can be routed to two areas of Summit: they may be added to the main signal processing chain either before or after the Filter section; this routing is enabled with the AudioInput function on Page 3 of the **Voice** menu (see page 24). The second use for them is to route them to the FX section, so Summit's FX processing may be applied. This routing is enabled on Page C of the **Settings** menu (see page 43).

Initialise Mode

Displayed as:	Initialise
Default value:	IniPatch
Range of adjustment:	IniPatch, Live

With the default setting of IniPatch, pressing the **Initialise** button (2) will load an Initial Patch, complete with all its default parameter values, giving you a useful starting point for creating new sounds. In Single Patch mode, this will be Init Patch; in Multi Patch mode, only the Part currently selected by **MULTIPART CONTROL** will be Init Patch.

By setting the Initialise parameter to Live, Summit will retain all current control panel settings when loading the Initial Patch, so any sound modification you have been working on will now be applied to a copy of the Initial Patch when **Initialise** is pressed. Note that this applies *only* to the physical controls; any adjustments made to additional menu settings will be overridden and replaced by those pertaining to the Initial Patch.

Output Routing Page:

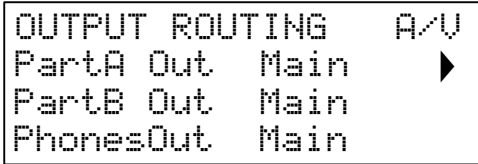

Main Output Routing - Part A

Displayed as: PartA Out
 Default value: Main
 Range of adjustment: Main, AUX

Summit lets you get the maximum advantage from its bi-timbral architecture by giving you the option of routing each of the two Parts to different stereo outputs. The default settings route both Parts to the **MAIN OUTPUTS** (7), but you can route either to the **AUX OUTPUTS** (8) instead if you wish. This lets you send the two Parts out of Summit independently to a mixer for separate level control, or to record them on separate tracks of a DAW or external multitrack recorder. It also gives you the option of sending one Part to an external effects unit.

PartA Out lets you choose which of Summit's two stereo outputs Part A is routed to.

Main Output Routing - Part B

Displayed as: PartB Out
 Default value: Main
 Range of adjustment: Main, AUX

See above for details.

PartB Out lets you choose which of Summit's two stereo outputs Part B is routed to.

Headphone Source

Displayed as: PhonesOut
 Default value: Main
 Range of adjustment: Main, AUX, Split

PhonesOut selects the signal available at the **HEADPHONES** output (9). The headphones will "follow" one or other of the two stereo outputs, Main or AUX. In either of these settings you will hear whatever is currently routed to the Main or AUX Output, in stereo. With the default settings, both Parts A and B are routed to the Main Output, so if PhonesOut is set to Main, you will hear both Parts in full stereo.

The third option, Split, routes a mono (L+R) sum of the signal assigned to the Main Output to the left earpiece, and a mono sum of the signal assigned to the AUX Output to the right. This is a useful setting to use if you are sending the two Parts to different outputs.

FX Pages:

The Settings menu has three pages related to Summit's FX sections.

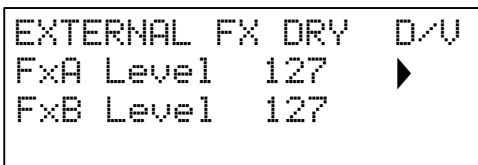
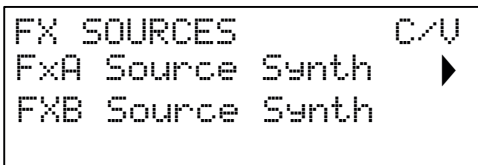
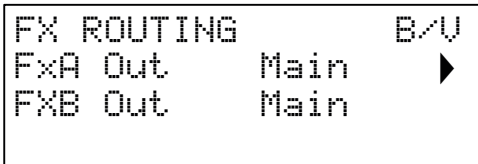

FX Routing - Part A

Displayed as: FxA Out
 Default value: Main
 Range of adjustment: Main, AUX

Summit lets you route the "wet" outputs of the two FX processors (for Parts A and B) – the processed signal - independently of the "dry", or unprocessed signal. The default setting is for the output of both processors to be routed to the Main Output, but you can route either or both of them to the AUX Output instead if you wish.

FxA Out lets you choose which stereo output the Part A processor is routed to.

FX Routing - Part B

Displayed as: FxB Out
 Default value: Main
 Range of adjustment: Main, AUX

See above for details.

FxB Out lets you choose which stereo output the Part B processor will be routed to.

FX Source - Part A

Displayed as: FxA Source
 Default value: Synth
 Range of adjustment: Synth, Extern

The default setting – Synth – routes the final output of Summit's Part A synth signal chain to the input of the Part A FX processor, in order that effects can be added to the synth sound.

You can also use the Part A FX processor to add effects to external signals connected to the rear panel **INPUTS** sockets (10). This alternative routing is made by setting FxA Source to Extern. In this case, the FX section will only process incoming external audio and will no longer be available to process Part A of the synth sound.

FX Source - Part B

Displayed as: FxB Source
 Default value: Synth
 Range of adjustment: Synth, Extern

The default setting – Synth – routes the final output of Summit's Part B synth signal chain to the input of the Part B FX processor, in order that effects can be added to the synth sound.

You can also use the Part B FX processor to add effects to external signals connected to the rear panel **INPUTS** sockets (10). This alternative routing is made by setting FxB Source to Extern. In this case, the FX section will only process incoming external audio and will no longer be available to process Part B of the synth sound.

External FX Level - Processor A

Displayed as: FxA Level
 Default value: 127
 Range of adjustment: 0 to 127

This control determines the level of the external input signal to be mixed with the output of the Part A FX processor. With the default setting of 127 (maximum), the input (or "dry") signal will be heard at full level. At a setting of zero, the input signal will not be present at the output and only the processed (or "wet") signal will be heard.

This setting may be relevant if you are using the FX section in a send-and-return loop from an external mixer: in this situation it is normal to mix the processed return signal with the dry input signal within the mixer.

External FX Level – Processor B

Displayed as: FxB Level
Default value: 127
Range of adjustment: 0 to 127

This control performs the same function as FxA Level above for the Part B FX processor.

Backup Page:

Novation recommends the use of Novation Components online Librarian to fully manage your Patches – see page 45. However, you may also import and export Patch data via MIDI SysEx messages, using applications such as SysEx Librarian (Mac) or MIDI-OX (Windows).

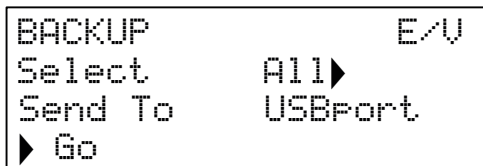

Select Patches

Displayed as: Select
Default value: All
Range of adjustment: PCurrent, P bank A, P bank B, P bank C, P bank D, P ABCD, Mcurrent, M bank A, M bank B, M bank C, M bank D, M ABCD, Settings, All

Select lets you choose which Patches to back up as SysEx data. You can choose either the currently active Patch (Current), or any or all of the four Banks in full (128 Patches per Bank) of either Single Patches (prefix P) or Multi Patches (prefix M). The two options P ABCD and M ABCD select all four Banks of Single or Multi Patches respectively.

You can also choose to back up all the current synth settings (choose Settings), or the current synth settings plus every Single and Multi Patch (choose All).

Dump Port Select

Displayed as: Send To
Default value: USBport
Range of adjustment: USBport, MIDIout

You can choose to send the SysEx data via either the **MIDI OUT** socket or the USB port, with the SendTo setting. When you are ready to do the data dump, select the lower left-hand screen button, Go, to perform the action.

Keyboard Settings:

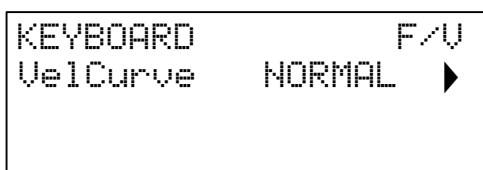

Displayed as: VelCurve
Default value: NORMAL
Range of adjustment: HIGH, NORMHI, NORMAL, NORMLO, LOW

The VelCurve parameter operates in conjunction with the Velocity parameter, which is set on Page 1 of the Env menu.

The response to velocity information from the keyboard may be set using this function. A setting of HIGH indicates smaller changes in velocity (a lighter playing style) will create a large change in response to velocity, be it volume or any other modulation destination velocity is routed to. A setting of LOW indicates larger changes of velocity - a much harder playing style, will create larger changes in response to velocity. NORMAL is obviously a compromise between these two, and NORMHI and NORMLO further intermediate values.

Tuning Table pages

Summit gives you the capability to alter the intervals between notes on your keyboard, letting you create alternative keyboard scales to the standard twelve-tone "Western" tuning we are all familiar with.

This is achieved by the use of Tuning Tables, which are effectively "lookup tables" for the oscillators, which tell them what frequency to generate when any particular key is struck. There are 17 Tuning Tables in all, and selection of the Table to be used is made on Page 1 of the Oscillator Menu.

By default, the oscillators use Tuning Table 0, which generates standard Equal Temperament tuning. The remaining 16 tables have the same default data (thus selecting them without any prior modification will also produce standard Equal Temperament tuning), but they may be altered to create any keyboard scale or layout you wish to use. This allows you to create new chords and harmonies not achievable with standard tuning.

Each of the 16 definable Tuning Tables has its own page: these are Pages G to V of the Settings menu. The pages are identical: the default page for Tuning Table 1 is shown below as an example.

Bear in mind you won't hear the effect of changing any Tuning Table parameters unless the Tuning Table being set up is selected in Page 1 of the Oscillator Menu.

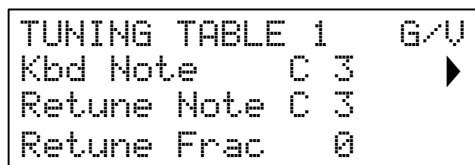

Keyboard Note

Displayed as: Kbd Note
Default value: C 3
Range of adjustment: C-2 to G 8

This parameter sets the keyboard note whose pitch is to be redefined. Kbd Note will follow the last key struck: if you hit middle C without any octave shift or other transposition being applied by the keyboard itself, Kbd Note will assume the value C 3. If octave shift or transposition is active on the keyboard, the MIDI data sent will be changed and the parameter will accordingly display the shifted note value.

Retuned Note

Displayed as: Retune Note
Default value: C 3
Range of adjustment: C-2 to G 8

Once you define the keyboard note to be redefined with Kbd Note, you can set Retune Note to any note, above or below Kbd Note. Then when you play the note defined by Kbd Note, you will hear the note defined by Retune Note.

Retune Note will always display the note actually being generated, and will by default be the same value as Kbd Note before any retuning is applied. Once a key has been redefined, Kbd Note will confirm which key is being pressed, while Retune Note will display the actual note being generated by that key.

Micro Intervals

Displayed as: Retune Frac
Default value: 0
Range of adjustment: 0 to 255, repeating

Using Tuning Tables does not restrict you only to standard note intervals. Summit supports "microtuning", whereby any key can be made to generate an "in-between" note, to a resolution of 1/256th of a semitone (0.4 cents). With Retune Frac set to 0, the note being defined (Kbd Note) will adopt the pitch value set by Retune Note. As Retune Frac is increased, the note's pitch sharpens by one micro interval at a time. When Retune Frac reaches a value of 255, one further step will generate the next standard note in the scale, and the value will reset to zero. By the same principle, the parameter may also be decreased in micro intervals to flatten the note.



Quarter tones – as found in many eastern music scales – can be created by setting Retune Frac to 127.

Summit also supports Scala tuning files, which provide a range of interesting and unusual scales. Scala files are added via Novation Components. You can find out more at huygens-fokker.org/scala/. MIDI Tuning Standard (MTS)

Messages are also supported allowing tuning files to be modified or exchanged between devices.

APPENDIX

System Updates using Novation Components

Novation Components is an online Patch Librarian, which allows you to manage your Patch library. You can also restore original factory Patches and download new ones as they become available.

Novation Components will also advise you if your Summit's Firmware is out of date and will update it for you if necessary.

Full details are available at novationmusic.com/register

Patch import via SysEx

It is also possible to import Patch data into Summit via MIDI SysEx messages, using applications such as SysEx Librarian (Mac) or MIDI-OX (Windows). It is important to note Patch Banks retain a reference to their original memory location and will be loaded back into that location on import. Thus any Patches already in those locations will be overwritten.

Sync values tables

Arp/Clock Sync Rate

This table lists the sync rate divisions available for the Arpeggiator clock SyncRate parameter (**Arp/Clock** menu, page 3).

Display	Display Meaning	Musical Description	MIDI Ticks*
8 beats	8 beats	1 cycle per 2 bars	192
6 beats	6 beats	1 cycle per 6 beats (2 cycles per 3 bars)	144
5 + 1/3	5 + 1/3	3 cycles per 4 bars	128
4 beats	4 beats	1 cycle per 1 bar	96
3 beats	3 beats	1 cycle per 3 beats (4 cycles per 3 bars)	72
2 + 2/3	2 + 2/3	3 cycles per 2 bars	64
2nd	2nd	2 cycles per 1 bar	48
4th D	4th dotted	2 cycles per 3 beats (8 cycles per 3 bars)	36
1 + 1/3	1 + 1/3	3 cycles per 1 bar	32
4th	4th	4 cycles per 1 bar	24
8th D	8th dotted	4 cycles per 3 beats (16 cycles per 3 bars)	18
4th T	4th triplet	6 cycles per 1 bar	16
8th	8th	8 cycles per 1 bar	12
16th D	16th dotted	8 cycles per 3 beats (32 cycles per 3 bars)	9
8th T	8th triplet	12 cycles per 1 bar	8
16th	16th	16 cycles per 1 bar	6
16th T	16th triplet	24 cycles per 1 bar	4
32nd	32nd	32 cycles per 1 bar	3
32nd T	32nd triplet	48 cycles per 1 bar	2

* Assuming a resolution of 24 PPQN

Delay Sync Rate

This table lists the sync rate divisions available for the DelaySync parameter (**FX** Menu, page 4).

Display	Display Meaning	Musical Description	MIDI Ticks*
4 beats	4 beats	1 cycle per 1 bar	96
3 beats	3 beats	1 cycle per 3 beats (4 cycles per 3 bars)	72
2 + 2/3	2 + 2/3	3 cycles per 2 bars	64
2nd	2nd	2 cycles per 1 bar	48
4th D	4th dotted	2 cycles per 3 beats (8 cycles per 3 bars)	36
1 + 1/3	1 + 1/3	3 cycles per 1 bar	32
4th	4th	4 cycles per 1 bar	24
8th D	8th dotted	4 cycles per 3 beats (16 cycles per 3 bars)	18
4th T	4th triplet	6 cycles per 1 bar	16
8th	8th	8 cycles per 1 bar	12
16th D	16th dotted	8 cycles per 3 beats (32 cycles per 3 bars)	9
8th T	8th triplet	12 cycles per 1 bar	8
16th	16th	16 cycles per 1 bar	6
16th T	16th triplet	24 cycles per 1 bar	4
32nd	32nd	32 cycles per 1 bar	3
32nd T	32nd triplet	48 cycles per 1 bar	2

* Assuming a resolution of 24 PPQN

LFO Sync Rate

This table lists the sync rate divisions available for the LFO Sync clock; these are displayed when an LFO Rate control [27] is adjusted with Range [26] set to Sync.

Display	Display Meaning	Musical Description	MIDI Ticks*
64 beats	64 beats	1 cycle per 16 bars	1536
48 beats	48 beats	1 cycle per 12 bars	1152
42 beats	42 beats	2 cycles per 21 bars	1008
36 beats	36 beats	1 cycle per 9 bars	864
32 beats	32 beats	1 cycle per 8 bars	768
30 beats	30 beats	2 cycles per 15 bars	720
28 beats	28 beats	1 cycle per 7 bars	672
24 beats	24 beats	1 cycle per 6 bars	576
21 + 1/3	21 + 1/3	3 cycles per 16 bars	512
20 beats	20 beats	1 cycle per 5 bars	480
18 + 2/3	18 + 2/3	3 cycles per 14 bars	448
18 beats	18 beats	1 cycle per 18 beats (2 cycles per 9 bars)	432
16 beats	16 beats	1 cycle per 4 bars	384
13 + 1/3	13 + 1/3	3 cycles per 4 bars	320
12 beats	12 beats	1 cycle per 12 beats (1 cycle per 3 bars)	288
10 + 2/3	10 + 2/3	3 cycles per 8 bars	256
8 beats	8 beats	1 cycle per 2 bars	192
6 beats	6 beats	1 cycle per 6 beats (2 cycles per 3 bars)	144
5 + 1/3	5 + 1/3	3 cycles per 4 bars	128
4 beats	4 beats	1 cycle per 1 bar	96
3 beats	3 beats	1 cycle per 3 beats (4 cycles per 3 bars)	72
2 + 2/3	2 + 2/3	3 cycles per 2 bars	64
2nd	2nd	2 cycles per 1 bar	48
4th D	4th dotted	2 cycles per 3 beats (8 cycles per 3 bars)	36
1 + 1/3	1 + 1/3	3 cycles per 1 bar	32
4th	4th	4 cycles per 1 bar	24
8th D	8th dotted	4 cycles per 3 beats (16 cycles per 3 bars)	18
4th T	4th triplet	6 cycles per 1 bar	16
8th	8th	8 cycles per 1 bar	12
16th D	16th dotted	8 cycles per 3 beats (32 cycles per 3 bars)	9
8th T	8th triplet	12 cycles per 1 bar	8
16th	16th	16 cycles per 1 bar	6
16th T	16th triplet	24 cycles per 1 bar	4
32nd	32nd	32 cycles per 1 bar	3
32nd T	32nd triplet	48 cycles per 1 bar	2

* Assuming a resolution of 24 PPQN

List of Wavetables

BS sine	String	Glassy	Spirals
Random	BassOrgn	Granular	Steel
Zing	Acid	Grime	Sunrise
Tubey	Buzzy	Drow	Swell
Octaves	Carousel	Heavy	Thicker
Wobbler	Choral	Hedge	Thinner
Chords	Climbing	Hungry	Tides
Didgery	CoinFlip	Ladders	Tokyo
Harsh	Deep	Lead	Tops
Organ	Dub	Modeling	V.Chord
E. Piano	Eee	Modem	Variance
VoxOooEe	Eris	Monster	Vocaloid
VoxYahEe	Flame	Screech	Vowelled
Winds	Further	SeaBase	WeirdVox
SoftClav	GlassSaw	Shmorgan	Yeah

MIDI operation in Single and Multi Patch modes

MIDI CHANNEL			
	GLOBAL	PART A	PART B
Single Patches			
	MIDI data is transmitted and received on the Global Channel only	No data transmitted or received	
Multi Patches - MIDI Rx			
LAYER MODE	MIDI data received regardless of which Part is selected	Data for each Part accepted on its assigned channel	
SPLIT MODE	Data not accepted		
DUAL MODE	Data accepted if MULTIPART CONTROL is set to Both		
Multi Patches - MIDI Tx			
LAYER MODE	No data transmitted	Data for each Part is transmitted separately on its assigned channel	
SPLIT MODE			
DUAL MODE			

Modulation Matrix - sources

The table below lists the sources of modulation available to Inputs A and B of each Slot in the Modulation Matrix.

Display	Controlling Source
Direct	The Depth control ([10]; select Row 4)
ModWheel	Mod Wheel
AftTouch	Keyboard aftertouch
ExprPED1	Expression pedal connected at PEDAL 1 input
BrthPED2	Expression pedal connected at PEDAL 2 input
Velocity	Keyboard velocity
Keyboard	Key position on keyboard
Lfo1+	LFO 1 waveform varies controlled parameter in a positive sense
Lfo1+/-	LFO 1 waveform varies controlled parameter both positively and negatively
Lfo2+	LFO 2 waveform varies controlled parameter in a positive sense
Lfo2+/-	LFO 2 waveform varies controlled parameter both positively and negatively
AmPEnv	Amplitude envelope
ModEnv1	Modulation envelope 1
ModEnv2	Modulation envelope 2
Animate1	Animate Button 1
Animate2	Animate Button 2
CV +/-	CV input varies controlled parameter both positively and negatively
Lfo3 +	LFO 3 waveform varies controlled parameter in a positive sense
Lfo3 +/-	LFO 3 waveform varies controlled parameter both positively and negatively
Lfo4 +	LFO 4 waveform varies controlled parameter in a positive sense
Lfo4 +/-	LFO 4 waveform varies controlled parameter both positively and negatively
BndWhl+	Pitch Bend wheel up increases parameter
BndWhl-	Pitch Bend wheel up decreases parameter

Modulation Matrix - destinations

The table below lists the destinations you can route each Modulation Matrix slot to.

Display	Controlling Source
O123Ptch	Frequency of all three oscillators
Osc1Ptch	Oscillator 1 frequency
Osc2Ptch	Oscillator 2 frequency
Osc3Ptch	Oscillator 3 frequency
Osc1VSync	Oscillator 1 VSync level
Osc2VSync	Oscillator 2 VSync level
Osc3VSync	Oscillator 3 VSync level
Osc1Shpe	Oscillator 1 Shape Amount
Osc2Shpe	Oscillator 2 Shape Amount
Osc3Shpe	Oscillator 3 Shape Amount
Osc1 Lev	Oscillator 1 level
Osc2 Lev	Oscillator 2 level
Osc3 Lev	Oscillator 3 level
NoiseLev	Noise source level

Modulation Matrix - destinations continued

Ring Lev	Ring Modulator output level (RM inputs are Osc 1 and Osc 2)
VcaLevel	Overall synth output level
Filt Drv	Pre-filter Overdrive
FiltDist	Post-filter Distortion
FiltFrea	Filter cut-off frequency (or centre frequency when Shape=BP)
Filt Res	Filter Resonance
Lfo1Rate	LFO 1 frequency
Lfo2Rate	LFO 2 frequency
AmPEnv A	Attack time of Amplitude envelope
AmPEnv D	Decay time of Amplitude envelope
AmPEnv R	Release time of Amplitude envelope
ModEnv1A	Attack time of Modulation envelope 1
ModEnv1D	Decay time of Modulation envelope 1
ModEnv1R	Release time of Modulation envelope 1
ModEnv2A	Attack time of Modulation envelope 2
ModEnv2D	Decay time of Modulation envelope 2
ModEnv2R	Release time of Modulation envelope 2
FM O1>O2	Depth of Frequency modulation applied to Oscillator 2 by Oscillator 1*
FM O2>O3	Depth of frequency modulation applied to Oscillator 3 by Oscillator 2*
FM O3>O1	Depth of frequency modulation applied to Oscillator 1 by Oscillator 3*
FM Ns>O1	Amount of noise modulation applied to Oscillator 1*
O3>FiltF	Degree of control of filter cut-off/centre frequency by Oscillator 3*
Ns>FiltF	Degree of control of filter cut-off/centre frequency by noise source*
FfreaSep	Difference between the frequencies of two filters when used in combination

* Note that only positive values of **Depth** are effective for the FM options; all negative values are considered as zero.

FX Modulation Matrix - sources

The table below lists the sources of modulation available to Inputs A and B of each Slot in the FX Modulation Matrix.

Display	Controlling Source
Direct	The Depth control ([10]; select Row 4)
ModWheel	Mod Wheel
AftTouch	Keyboard aftertouch
ExprPED1	Expression pedal connected at PEDAL 1 input
BrthPED2	Expression pedal connected at PEDAL 2 input
Velocity	Keyboard velocity
Keyboard	Key position on keyboard
Animate1	Animate Button 1
Animate2	Animate Button 2
CV +/-	CV input varies controlled parameter both positively and negatively
Lfo3 +	LFO 3 waveform varies controlled parameter in a positive sense
Lfo3 +/-	LFO 3 waveform varies controlled parameter both positively and negatively
Lfo4 +	LFO 4 waveform varies controlled parameter in a positive sense
Lfo4 +/-	LFO 4 waveform varies controlled parameter both positively and negatively
BndWhl+	Pitch Bend wheel up: increases parameter
BndWhl-	Pitch Bend wheel up: decreases parameter

FX Modulation Matrix - destinations

The table below lists the destinations you can route each FX Modulation Matrix Slot to.

Display	Controlled Parameter
Dist Lev	Distortion Level
Chor Lev	Chorus Level
ChorRate	Chorus Rate
Chor Dep	Chorus Depth
Chor FB	Chorus Feedback
Del Lev	Delay Level
Del Time	Delay Time
Del FB	Delay Feedback
Rev Lev	Reverb Level
Rev Time	Reverb Time
Rev LPF	Reverb Low Pass
Rev HPF	Reverb High Pass

MIDI parameters list

Parameter	CC/ NRPN	Control Number.	Range	Default Value
Patch Category	NRPN	0:0	0-14	0
Patch Genre	NRPN	0:1	0-9	0
Voice Mode	NRPN	0:2	0-4	3
Voice Unison	NRPN	0:3	0-4	0
Voice Unison Detune	NRPN	0:4	0-127	25
Voice Unison Spread	NRPN	0:5	0-127	0
Voice Keyboard Octave	NRPN	0:6	61-67 (-3 to +3)	64 (0)
Glide Time	CC	5	0-127 (0 to +127)	0 (60)
Voice Pre-Glide	NRPN	0:7	52-76 (-12 to +12)	64 (Off)
Glide On	CC	35	0-1 (0 to +1)	0 (0)
Oscillators				
Osc Common Diverge	NRPN	0:9	0-127 (0 to +127)	0 (0)
Osc Common Drift	NRPN	0:10	0-127 (0 to +127)	0 (0)
Osc Common Noise LPF	NRPN	0:11	0-127 (0 to +127)	127
Oscillator 1 Range	CC	3	63-66 (-1 to +2)	64 (0)
Oscillator 1 Coarse	CC pair	14, 46	0-255 (-128 to +127)	128 (0)
Oscillator 1 Fine	CC pair	15, 47	28-228 (-100 to +100)	128 (0)
Oscillator 1 ModEnv2 > Pitch	CC	9	1-127 (-63 to +63)	64 (0)
Oscillator 1 LFO2 > Pitch	CC pair	16, 48	1-255 (-127 to +127)	128 (0)
Oscillator 1 Wave	NRPN	0:14	0-4 (0 to +4)	0 (2)
Oscillator 1 Wave More	NRPN	0:15	4-63 (4 to +63)	0 (4)
Oscillator 1 Shape Source	NRPN	0:16	0-2 (0 TO +2)	0 (0)
Oscillator 1 Manual Shape	CC	12	0-127 (-64 to +63)	64 (0)
Oscillator 1 ModEnv1 > Shape	CC	119	0-127 (-64 to +63)	64 (0)
Oscillator 1 LFO1 > Shape	CC	33	1-127 (-64 to +63)	64 (0)
Oscillator 1 Vsync	CC	34	0-127 (0 to +127)	0 (0)
Oscillator 1 Saw Density	NRPN	0:17	0-127 (0 to +127)	0 (0)
Oscillator 1 Saw Density Detune	NRPN	0:18	0-127 (0 to +127)	0
Oscillator 1 Fixed Note	NRPN	0:19	0-88 (0 to +88)	0 (Off)
Oscillator 1 Bend Range	NRPN	0:20	40-88 (-24 to +24)	76
Oscillator 2 Range	CC	37	63-66 (-1 to +2)	64 (0)
Oscillator 2 Coarse	CC pair	17, 49	0-255 (-128 to +127)	64
Oscillator 2 Fine	CC pair	18, 50	28-228 (-100 to +100)	64
Oscillator 2 ModEnv2 > Pitch	CC	38	1-127 (-63 to +63)	64 (0)
Oscillator 2 LFO2 > Pitch	CC pair	19, 51	1-255 (-127 to +127)	64
Oscillator 2 Wave	NRPN	0:23	0-4 (0 to +4)	0 (2)
Oscillator 2 Wave More	NRPN	0:24	4-63 (4 to +63)	0 (4)
Oscillator 2 Shape Source	NRPN	0:25	0-2 (0 TO +2)	0 (0)
Oscillator 2 Manual Shape	CC	39	0-127 (-64 to +63)	64 (0)
Oscillator 2 ModEnv1 > Shape	CC	40	0-127 (-64 to +63)	64 (0)
Oscillator 2 LFO1 > Shape	CC	41	1-127 (-64 to +63)	64 (0)
Oscillator 2 Vsync	CC	42	0-127 (0 to +127)	0 (0)

Parameter	CC/ NRPN	Control Number.	Range	Default Value
Oscillator 2 Saw Density	NRPN	0:26	0-127 (0 to +127)	0 (0)
Oscillator 2 Saw Density Detune	NRPN	0:27	0-127 (0 to +127)	0 (64)
Oscillator 2 Fixed Note	NRPN	0:28	0-88 (0 to +88)	0 (Off)
Oscillator 2 Bend Range	NRPN	0:29	40-88 (-24 to +24)	76 (12)
Oscillator 3 Range	CC	65	63-66 (-1 to +2)	64 (0)
Oscillator 3 Coarse	CC pair	20, 52	0-255 (-128 to +127)	128 (0)
Oscillator 3 Fine	CC pair	21, 53	28-228 (-100 to +100)	128 (0)
Oscillator 3 ModEnv2 > Pitch	CC	43	1-127 (-63 to +63)	64 (0)
Oscillator 3 LFO2 > Pitch	CC pair	22,54	1-255 (-127 to +127)	128 (0)
Oscillator 3 Wave	NRPN	0:32	0-4 (0 to +4)	0 (2)
Oscillator 3 Wave More	NRPN	0:33	4-63 (4 to +63)	0 (4)
Oscillator 3 Shape Source	NRPN	0:34	0-2 (0 TO +2)	0 (0)
Oscillator 3 Manual Shape	CC	71	0-127 (-64 to +63)	64 (0)
Oscillator 3 ModEnv1 > Shape	CC	72	0-127 (-64 to +63)	64 (0)
Oscillator 3 LFO1 > Shape	CC	73	1-127 (-64 to +63)	64 (0)
Oscillator 3 Vsync	CC	44	0-127 (0 to +127)	0 (0)
Oscillator 3 Saw Density	NRPN	0:35	0-127 (0 to +127)	0 (0)
Oscillator 3 Saw Density Detune	NRPN	0:36	0-127 (0 to +127)	0 (64)
Oscillator 3 Fixed Note	NRPN	0:37	0-88 (0 to +88)	0 (Off)
Oscillator 3 Bend Range	NRPN	0:38	40-88 (-24 to +24)	76 (12)
Mixer				
Mixer Osc1	CC pair	23,55	0-255 (0 to +255)	255
Mixer Osc2	CC pair	24,56	0-255 (0 to +255)	0 (0)
Mixer Osc3	CC pair	25,57	0-255 (0 to +255)	0 (0)
Ring 1*2 Level	CC pair	26,58	0-255 (0 to +255)	0 (0)
Noise Level	CC pair	27,59	0-255 (0 to +255)	0 (0)
Mixer Patch Level	NRPN	0:41	0-127 (0 to +127)	64
Mixer VCA gain	NRPN	0:42	0-127 (0 to +127)	127
Mixer Dry Level	NRPN	0:43	0-127 (0 to +127)	127
Mixer Wet Level	NRPN	0:44	0-127 (0 to +127)	127
Filter				
Filter Overdrive	CC	80	0-127 (0 to +127)	0 (0)
Filter Post Drive	CC	36	0-127 (0 to +127)	0 (0)
Filter Slope	NRPN	0:45	0-1 (0 to +1)	1
Filter Shape	NRPN	0:46	0-2 (0 to +2)	0 (0)
Filter Key Tracking	CC	75	0-127 (0 to +127)	127
Filter Resonance	CC	79	0-127 (0 to +127)	0 (0)
Filter Frequency	CC pair	29, 61	0-255 (0 to +255)	0 (255)
Filter LFO1 > Filter	CC pair	28, 60	1-255 (-127 to +127)	128 (0)
Filter Osc3 > Filter	CC	76	0-127 (0 to +127)	0 (0)
Filter Env Select	NRPN	0:47	0-1 (0 to +1)	0 (1)
Filter AmpEnv > Filter	CC	77	1-127 (-63 to +63)	64 (0)
Filter ModEnv1 > Filter	CC	78	1-127 (-63 to +63)	64 (0)
Filter Divergence	NRPN	0:48	0-127 (0 to +127)	0 (0)

Parameter	CC/ NRPN	Control Number.	Range	Default Value
Envelopes				
Amp Envelope Attack	CC	86	0-127 (0 to +127)	0
Amp Envelope Decay	CC	87	0-127 (0 to +127)	90
Amp Envelope Sustain	CC	88	0-127 (0 to +127)	127
Amp Envelope Release	CC	89	0-127 (0 to +127)	40
Amp Envelope Velocity	NRPN	0:55	0-127 (-64 to +63)	64 (0)
Amp Envelope Trigger	NRPN	0:56	0-1 (0 to +1)	0
Mod Envelope Select	NRPN	0:59	0-1 (0 to +1)	0 (1)
Mod Envelope 1 Attack	CC	90	0-127 (0 to +127)	0
Mod Envelope 1 Decay	CC	91	0-127 (0 to +127)	75
Mod Envelope 1 Sustain	CC	92	0-127 (0 to +127)	35
Mod Envelope 1 Release	CC	93	0-127 (0 to +127)	45
Mod Envelope 1 Velocity	NRPN	0:60	0-127 (-64 to +63)	64 (0)
Mod Envelope 1 Trigger	NRPN	0:61	0-1 (0 to +1)	0 (1)
Mod Envelope 2 Attack	CC	94	0-127 (0 to +127)	0
Mod Envelope 2 Decay	CC	95	0-127 (0 to +127)	75
Mod Envelope 2 Sustain	CC	117	0-127 (0 to +127)	35
Mod Envelope 2 Release	CC	103	0-127 (0 to +127)	45
Mod Envelope 2 Velocity	NRPN	0:64	0-127 (-64 to +63)	64 (0)
Mod Envelope 2 Trigger	NRPN	0:65	0-1 (0 to +1)	0 (1)
LFOs				
LFO 1 Range	NRPN	0:68	0-2 (0 to +2)	0 (0)
LFO 1 Rate	CC pair	30, 62	0-255 (0 to +255)	128
LFO 1 Sync Rate	CC	81	0-34 (0 to +34)	16
LFO 1 Wave	NRPN	0:69	0-3 (0 to +3)	0 (0)
LFO 1 Phase	NRPN	0:70	0-120 (0 to +120)	0 (0)
LFO 1 Slew	NRPN	0:71	0-127 (0 to +127)	0 (0)
LFO 1 Fade Time	CC	82	0-127 (0 to +127)	0 (0)
LFO 1 Fade In/Out	NRPN	0:72	0-3 (0 to +3)	0 (0)
LFO 1 One Shot	NRPN	0:75	0-1 (0 to +1)	0 (0)
LFO 1 Common	NRPN	0:76	0-1 (0 to +1)	0 (0)
LFO 2 Range	CC	83	0-2 (0 to +2)	0 (0)
LFO 2 Rate	CC pair	31, 63	0-255 (0 to +255)	128
LFO 2 Sync Rate	CC	84	0-34 (0 to +34)	0 (12)
LFO 2 Wave	NRPN	0:78	0-3 (0 to +3)	0 (0)
LFO 2 Phase	NRPN	0:79	0-120 (0 to +120)	0 (0)
LFO 2 Slew	NRPN	0:80	0-127 (0 to +127)	0 (0)
LFO 2 Fade Time	CC	85	0-127 (0 to +127)	0 (0)
LFO 2 Fade In/Out	NRPN	0:81	0-3 (0 to +3)	0 (0)
LFO 2 One Shot	NRPN	0:84	0-1 (0 to +1)	0 (0)
LFO 2 Common	NRPN	0:85	0-1 (0 to +1)	0 (0)
Effects				
Distortion level	CC	104	0-127 (0 to +127)	0 (0)
Effects Master Bypass	NRPN	0:88	0-1 (0 to +1)	0 (0)
Effects Routing	NRPN	0:89		0 (0)
Delay Level	CC	108	0-127 (0 to +127)	0 (0)
Delay Time	CC	109	0-127 (0 to +127)	0 (64)

Parameter	CC/ NRPN	Control Number.	Range	Default Value
Delay Width	NRPN	0:92	0-127 (0 to +127)	0 (64)
Delay Sync	NRPN	0:93	0-1 (0 to +1)	0 (0)
Delay Sync Time	NRPN	0:94	0-18 (0 to +18)	0 (4)
Delay Feedback	CC	110	0-127 (0 to +127)	0 (64)
Delay LP Damp	NRPN	0:95	0-127 (0 to +127)	85
Delay HP Damp	NRPN	0:96	0-127 (0 to +127)	0 (0)
Delay Slew Rate	NRPN	0:97	0-127 (0 to +127)	32
Reverb Level	CC	112	0-127 (0 to +127)	0 (0)
Reverb Type	NRPN	0:101	0-2 (0 to +2)	2
Reverb Time	CC	113	0-127 (0 to +127)	0 (90)
Reverb Damping LP	NRPN	0:102	0-127 (0 to +127)	0 (50)
Reverb Damping HP	NRPN	0:103	0-127 (0 to +127)	0 (1)
Reverb Size	NRPN	0:104	0-127 (0 to +127)	64
Reverb Mod	NRPN	0:105	0-127 (0 to +127)	64
Reverb Mod Rate	NRPN	0:106	0-127 (0 to +127)	0 (4)
Reverb Low Pass	NRPN	0:107	0-127 (0 to +127)	0 (74)
Reverb High Pass	NRPN	0:108	0-127 (0 to +127)	0 (0)
Reverb Pre Delay	NRPN	0:109	0-127 (0 to +127)	40
Chorus Level	CC	105	0-127 (0 to +127)	0 (0)
Chorus Type	NRPN	0:111		2
Chorus Rate	CC	118	0-127 (0 to +127)	20
Chorus Mod Depth	NRPN	0:112	0-127 (0 to +127)	0 (64)
Chorus Feedback	CC	107	0-127 (-64 to +63)	64
Chorus LP	NRPN	0:113	0-127 (0 to +127)	90
Chorus HP	NRPN	0:114	0-127 (0 to +127)	2
ARP				
Arp/Clock Rate	NA	NA:NA	40-240 (40 to +240)	120
Arp/Clock Sync Rate	NRPN	0:116	0-18 (0 to +18)	16th.
Arp/Clock Type	NRPN	0:117	0-6 (0 to +6)	0 (0)
Arp/Clock Rhythm	NRPN	0:118	0-32 (0 to +32)	0 (0)
Arp/Clock Octave	NRPN	0:119	0-5 (0 to +5)	1
Arp/Clock Gate	CC	116	0-127 (0 to +127)	64
Arp/Clock Swing	NRPN	0:120	20-80 (20 to +80)	50
Arp/Clock On	NRPN	0:121	0-1 (0 to +1)	0 (0)
Arp/Clock Key Latch	NRPN	0:122	0-1 (0 to +1)	0 (0)
Arp/Clock Key Sync	NRPN	0:123	0-1 (0 to +1)	0 (0)
ANIMATE				
Animate 1 Hold	CC	114	0-1 (0 to +1)	0 (0)
Animate 2 Hold	CC	115	0-1 (0 to +1)	0 (0)
MODULATION MATRIX				
Mod Matrix Selection	NRPN	0:125	0-15 (0 to +15)	0 (0)
Mod Matrix 1 Source1	NRPN	1:0	0-16 (0 to +16)	0 (0)
Mod Matrix 1 Source2	NRPN	1:1	0-16 (0 to +16)	0 (0)
Mod Matrix 1 Depth	NRPN	1:2	0-127 (-64 to +63)	64 (0)
Mod Matrix 1 Destination	NRPN	1:3	0-36 (0 to +36)	0 (0)
Mod Matrix 2 Source1	NRPN		0-16 (0 to +16)	0 (0)
Mod Matrix 2 Source2	NRPN		0-16 (0 to +16)	0 (0)

Parameter	CC/ NRPN	Control Number.	Range	Default Value
Mod Matrix 2 Depth	NRPN		0-127 (-64 to +63)	64 (0)
Mod Matrix 2 Destination	NRPN		0-36 (0 to +36)	0 (0)
Mod Matrix 3 Source1	NRPN		0-16 (0 to +16)	0 (0)
Mod Matrix 3 Source2	NRPN		0-16 (0 to +16)	0 (0)
Mod Matrix 3 Depth	NRPN		0-127 (-64 to +63)	64 (0)
Mod Matrix 3 Destination	NRPN		0-36 (0 to +36)	0 (0)
Mod Matrix 4 Source1	NRPN		0-16 (0 to +16)	0 (0)
Mod Matrix 4 Source2	NRPN		0-16 (0 to +16)	0 (0)
Mod Matrix 4 Depth	NRPN		0-127 (-64 to +63)	64 (0)
Mod Matrix 4 Destination	NRPN		0-36 (0 to +36)	0 (0)
Mod Matrix 5 Source1	NRPN		0-16 (0 to +16)	0 (0)
Mod Matrix 5 Source2	NRPN		0-16 (0 to +16)	0 (0)
Mod Matrix 5 Depth	NRPN		0-127 (-64 to +63)	64 (0)
Mod Matrix 5 Destination	NRPN		0-36 (0 to +36)	0 (0)
Mod Matrix 6 Source1	NRPN		0-16 (0 to +16)	0 (0)
Mod Matrix 6 Source2	NRPN		0-16 (0 to +16)	0 (0)
Mod Matrix 6 Depth	NRPN		0-127 (-64 to +63)	64 (0)
Mod Matrix 6 Destination	NRPN		0-36 (0 to +36)	0 (0)
Mod Matrix 7 Source1	NRPN		0-16 (0 to +16)	0 (0)
Mod Matrix 7 Source2	NRPN		0-16 (0 to +16)	0 (0)
Mod Matrix 7 Depth	NRPN		0-127 (-64 to +63)	64 (0)
Mod Matrix 7 Destination	NRPN		0-36 (0 to +36)	0 (0)
Mod Matrix 8 Source1	NRPN		0-16 (0 to +16)	0 (0)
Mod Matrix 8 Source2	NRPN		0-16 (0 to +16)	0 (0)
Mod Matrix 8 Depth	NRPN		0-127 (-64 to +63)	64 (0)
Mod Matrix 8 Destination	NRPN		0-36 (0 to +36)	0 (0)
Mod Matrix 9 Source1	NRPN		0-16 (0 to +16)	0 (0)
Mod Matrix 9 Source2	NRPN		0-16 (0 to +16)	0 (0)
Mod Matrix 9 Depth	NRPN		0-127 (-64 to +63)	64 (0)
Mod Matrix 9 Destination	NRPN		0-36 (0 to +36)	0 (0)
Mod Matrix 10 Source1	NRPN		0-16 (0 to +16)	0 (0)
Mod Matrix 10 Source2	NRPN		0-16 (0 to +16)	0 (0)
Mod Matrix 10 Depth	NRPN		0-127 (-64 to +63)	64 (0)
Mod Matrix 10 Destination	NRPN		0-36 (0 to +36)	0 (0)
Mod Matrix 11 Source1	NRPN		0-16 (0 to +16)	0 (0)
Mod Matrix 11 Source2	NRPN		0-16 (0 to +16)	0 (0)
Mod Matrix 11 Depth	NRPN		0-127 (-64 to +63)	64 (0)
Mod Matrix 11 Destination	NRPN		0-36 (0 to +36)	0 (0)
Mod Matrix 12 Source1	NRPN		0-16 (0 to +16)	0 (0)
Mod Matrix 12 Source2	NRPN		0-16 (0 to +16)	0 (0)
Mod Matrix 12 Depth	NRPN		0-127 (-64 to +63)	64 (0)
Mod Matrix 12 Destination	NRPN		0-36 (0 to +36)	0 (0)
Mod Matrix 13 Source1	NRPN		0-16 (0 to +16)	0 (0)
Mod Matrix 13 Source2	NRPN		0-16 (0 to +16)	0 (0)
Mod Matrix 13 Depth	NRPN		0-127 (-64 to +63)	64 (0)
Mod Matrix 13 Destination	NRPN		0-36 (0 to +36)	0 (0)
Mod Matrix 14 Source1	NRPN		0-16 (0 to +16)	0 (0)
Mod Matrix 14 Source2	NRPN		0-16 (0 to +16)	0 (0)

Parameter	CC/ NRPN	Control Number.	Range	Default Value
Mod Matrix 14 Depth	NRPN		0-127 (-64 to +63)	64 (0)
Mod Matrix 14 Destination	NRPN		0-36 (0 to +36)	0 (0)
Mod Matrix 15 Source1	NRPN		0-16 (0 to +16)	0 (0)
Mod Matrix 15 Source2	NRPN		0-16 (0 to +16)	0 (0)
Mod Matrix 15 Depth	NRPN		0-127 (-64 to +63)	64 (0)
Mod Matrix 15 Destination	NRPN		0-36 (0 to +36)	0 (0)
Mod Matrix 16 Source1	NRPN		0-16 (0 to +16)	0 (0)
Mod Matrix 16 Source2	NRPN		0-16 (0 to +16)	0 (0)
Mod Matrix 16 Depth	NRPN		0-127 (-64 to +63)	64 (0)
Mod Matrix 16 Destination	NRPN		0-36 (0 to +36)	0 (0)

Sound designers

We'd like to thank the fantastic souls who came on the journey with us to give a voice to Novation Summit. If you want to know more about them, you'll find links to their work below. The selected palette of sound attempts to display how flexible and beautiful or aggressive Summit can be.

We hope these sounds will help inspire your future composition and creation.

Sound Designer / Artist	If you want to know more about them...
Patricia Wolf	soundcloud.com/patriciawolf_music facebook.com/patriciawolfmusic
Gforce Software	gforcesoftware.com
Legowelt	legowelt.org
Inhalt	inhalt.us inhalt.bandcamp.com
Sandunes	sandunesmusic.com
Peter Dyer	peterdyer.net
Groundislava	soundcloud.com/groundislava facebook.com/groundislava
Tim Mantle / Psalm 37	timmantle.com/psalm37.html
Enrico Cosimi	mastersuono.uniroma2.it/team/dott-enrico-cosimi
R Beny	rbeny.bandcamp.com instagram.com/austinthecairns soundcloud.com/rbeny youtube.com/channel/UC5hhwOVY0lxIn4ELd5ZP1Bw
Chris Calcutt / Calc	youtube.com/user/boxkidnine
Alex Jann	soundcloud.com/alexjann facebook.com/alexjann.uk
Loz Jackson	lozjackson.com Loz is also one of the core developers of Novation Components
Tristan McGuire	Tristan is Novation Summit Lead Test Engineer
Danny Nugent	Summit's Product Designer
Jerome Meunier	facebook.com/myjima instagram.com/myjima

List of factory Patches with designer credits

Patch No.	Single Patches – Bank A		Single Patches – Bank B	
	Patch Name	Created by	Patch Name	Created by
0	Dystopian	Gforce Software	Dune Sunrise PAD	Sandunes
1	Buzzy Brass	Enrico Cosimi	Force Field	Patricia Wolf
2	Aetherphone	Patricia Wolf	Dearly Beloved	Peter Dyer
3	3 Osc BassSynth	Gforce Software	Triple Wavetable	Enrico Cosimi
4	GIL Deep Plane	Groundislava	Sergey Repetae	Inhalt
5	Death of a King	Tim Mantle/Psalm37	Careless Crystal	Tim Mantle/Psalm37
6	Epic Atmosphere	Gforce Software	4>8>12 UnisonPWM	Gforce Software
7	OperatahBass	Peter Dyer	80s Bell Patch	Gforce Software
8	Little Grey Bass	Gforce Software	80's Digi-Syn	Gforce Software
9	Simple & Sublime	Gforce Software	99to88to78	Gforce Software
10	Droom Wolk	Legowelt	Arc de Triumph	Gforce Software
11	Alpine Crystal	Legowelt	Arps Of Joy	Gforce Software
12	Amatorial Concept	Legowelt	Breathy Trumpet	Gforce Software
13	Arpeggi Trancy	Legowelt	Buzz BASS!	Gforce Software
14	Beautiful Bits	Legowelt	Dirt Guitar Lead	Gforce Software
15	Carnival of Soul	Legowelt	Dirty Bastard	Gforce Software
16	Coastal Hamlet	Legowelt	DoAnimate2&Bend	Gforce Software
17	Digital Dew	Legowelt	Dream Arp	Gforce Software
18	Eney Splash	Legowelt	Dukey Lead	Gforce Software
19	Experial Evil	Legowelt	Eerie ModW^	Gforce Software
20	Florist Study	Legowelt	Epic Flutter	Gforce Software
21	Forestfull	Legowelt	Fifths	Gforce Software
22	Frog Empirium	Legowelt	Floating Ether	Gforce Software
23	Hiphat Garden	Legowelt	Floating OnWaves	Gforce Software
24	Inverness Synth Shop	Legowelt	FM Piano Elec'	Gforce Software
25	Magic Castle	Legowelt	FM Xylo	Gforce Software
26	Precinct Bass	Legowelt	Fmod Bass	Gforce Software
27	Saucy Bass	Legowelt	Guitar Patch	Gforce Software
28	Spring Neptunium	Legowelt	Icicle Warmth	Gforce Software
29	Thera Atlantis	Legowelt	Little EP Tines	Gforce Software
30	\^/	Jerome Meunier	Little Strike	Gforce Software
31	Alpine Lake	Patricia Wolf	Music Box	Gforce Software
32	Ambient Arp	Patricia Wolf	Oldie Mogie	Gforce Software
33	Basement	Patricia Wolf	OwWaa Pad	Gforce Software
34	Bathysphere	Patricia Wolf	OxOsc Sync	Gforce Software
35	Beneath the Wave	Patricia Wolf	Rich Pad	Gforce Software
36	déjà vu Feeling	Patricia Wolf	Silky Retro Syn	Gforce Software
37	Dream Baby	Patricia Wolf	Simple Pad	Gforce Software
38	Dub Organ	Patricia Wolf	Soft OB	Gforce Software
39	Eating Tape	Patricia Wolf	Space Organ	Gforce Software
40	Electro-static	Patricia Wolf	Spiritual Skies	Gforce Software
41	Erosion	Patricia Wolf	Syn Clav	Gforce Software
42	Exorcism	Patricia Wolf	Three Digi Bells	Gforce Software
43	Found Sound	Patricia Wolf	Tino Moo	Gforce Software
44	From the Stars	Patricia Wolf	Voxarrhh Vocal	Gforce Software
45	Golden Egg	Patricia Wolf	You 70s FunkyCat	Gforce Software
46	Guitar Distorted	Patricia Wolf	Zither Guitar FX	Gforce Software
47	Hammered Dulcimer	Patricia Wolf	Wurli ModW Vib	Gforce Software
48	Haunting Memory	Patricia Wolf	Arpy Lead	Sandunes
49	Heliocentric	Patricia Wolf	Brass Stitcher	Sandunes
50	Hovercraft	Patricia Wolf	Chamber Pipes	Sandunes
51	Kick & Toms	Patricia Wolf	Cosmic Lead	Sandunes
52	Lace Timbre	Patricia Wolf	Crystal Sky	Sandunes
53	Life as a bee	Patricia Wolf	Detroitich	Sandunes
54	Lost At Sea	Patricia Wolf	Digi Harmonium	Sandunes
55	Mirage	Patricia Wolf	French Horn Pad	Sandunes
56	Mission Complete	Patricia Wolf	Glassy Drops	Sandunes

57	Secret Room	Patricia Wolf	Gluey Stab	Sandunes
58	Silver Bamboo	Patricia Wolf	Griffyndor	Sandunes
59	Snake Charmer	Patricia Wolf	Mars Arp	Sandunes
60	Spiritual Path	Patricia Wolf	Phat n Low	Sandunes
61	Talking Ghosts	Patricia Wolf	Round Sub	Sandunes
62	Techno Utopia	Patricia Wolf	Rubber Leady	Sandunes
63	Teles	Patricia Wolf	Rubber Sub Sub	Sandunes
64	Time-Lapse	Patricia Wolf	Sharp Wash	Sandunes
65	Vanishing Point	Patricia Wolf	Steely Dran	Sandunes
66	OverBiased	Peter Dyer	Sub Arp234	Sandunes
67	ArtilleryBass	Peter Dyer	Tasty Chorder	Sandunes
68	AyeEyeGuy	Peter Dyer	Tubey Sub	Sandunes
69	Big Hyper	Peter Dyer	Wail Pad	Sandunes
70	FestaBass	Peter Dyer	Wood Pecker	Sandunes
71	FlintTinder	Peter Dyer	Wurli Alloy	Sandunes
72	Gleamers	Peter Dyer	Alpha Omega	Inhalt
73	Gray Havens	Peter Dyer	Animate4Harmny	Inhalt
74	HouseLoveOrgan	Peter Dyer	Classic Keys	Inhalt
75	KlyMaxx	Peter Dyer	Clavier Sync	Inhalt
76	KnockDown Bass	Peter Dyer	Cocteau1	Inhalt
77	Let's Go Paisley	Peter Dyer	Cocteau2	Inhalt
78	MagneticBloom	Peter Dyer	Digital BodyBass	Inhalt
79	MeowMod	Peter Dyer	Fat Fifths	Inhalt
80	OpticalBurn	Peter Dyer	FM Bells	Inhalt
81	Origins	Peter Dyer	Gas,GrassOrBrass	Inhalt
82	Paste!Shores	Peter Dyer	Glacial Mood	Inhalt
83	PVC Kalimba	Peter Dyer	Harding Bass	Inhalt
84	Rewinder	Peter Dyer	LastTrain2Bass	Inhalt
85	StPeters2095	Peter Dyer	Linear Fifty	Inhalt
86	StringMachine	Peter Dyer	Liquid Rave Chrd	Inhalt
87	Supertanker	Peter Dyer	Malleit Vox!	Inhalt
88	That's Super	Peter Dyer	Midnight	Inhalt
89	Thumper	Peter Dyer	Neural Scanner	Inhalt
90	TimeBender	Peter Dyer	Orange Nightmare	Inhalt
91	Wow&Flutter	Peter Dyer	PleasureDome	Inhalt
92	WuvaaLova	Peter Dyer	PWM Pad	Inhalt
93	CommsErrorPad	Tristan McGuire	RadiophonicOrgan	Inhalt
94	EasterlyPlucks	Tristan McGuire	Risky Biz	Inhalt
95	StringSectionSwell	Tristan McGuire	StankFunk Bass	Inhalt
96	Woodwindsque	Tristan McGuire	Table Organ	Inhalt
97	Analog Dawn	Enrico Cosimi	Vox Humana A	Inhalt
98	Analog Kick MW	Enrico Cosimi	Vox Humana B	Inhalt
99	Analog Separatn	Enrico Cosimi	West Coast LPG	Inhalt
100	Analog Snare	Enrico Cosimi	EP Overdrive	Loz Jackson
101	Bass SubOsc	Enrico Cosimi	EP2	Loz Jackson
102	Bite Poly	Enrico Cosimi	EP4	Loz Jackson
103	Eighties Organ	Enrico Cosimi	LFO Bass	Loz Jackson
104	Eighties Brass	Enrico Cosimi	LFO Bass 2	Loz Jackson
105	Epic Sync LoopEG	Enrico Cosimi	LFO Bass 3	Loz Jackson
106	Eternal FM	Enrico Cosimi	Organ	Loz Jackson
107	FM Chaos	Enrico Cosimi	Soft Organ	Loz Jackson
108	Game Over	Enrico Cosimi	Saw Bass	Loz Jackson
109	HardSync Lead	Enrico Cosimi	Space Lead	Loz Jackson
110	LFO No Arpeggio	Enrico Cosimi	10p Ice Pops	Tim Mantle/Psalm37
111	Mellow Lead	Enrico Cosimi	70's NYC Jam	Tim Mantle/Psalm37
112	Pad 3SawDnsAftBP	Enrico Cosimi	Blockers	Tim Mantle/Psalm37
113	Pad Sawdense	Enrico Cosimi	Bounty by Grace	Tim Mantle/Psalm37
114	Power Fifth	Enrico Cosimi	Bronzer	Tim Mantle/Psalm37
115	Prog Lead	Enrico Cosimi	Catharsis	Tim Mantle/Psalm37
116	Ring Dyn Ambient	Enrico Cosimi	Cone Blown	Tim Mantle/Psalm37

117	SingleTrig Bass	Enrico Cosimi	Dalston Dream	Tim Mantle/Psalm37
118	Triangle Motion	Enrico Cosimi	Digi Bass Basics	Tim Mantle/Psalm37
119	Belmont Whip GIL	Groundislava	Elysian	Tim Mantle/Psalm37
120	Blue Dulcimer	Groundislava	Expansion Card	Tim Mantle/Psalm37
121	Crush Bass GIL	Groundislava	Hard Bowed	Tim Mantle/Psalm37
122	Faerie Ring GIL	Groundislava	Intimate Rotary	Tim Mantle/Psalm37
123	GIL's Memories	Groundislava	it's all Ours	Tim Mantle/Psalm37
124	Glassy Strider GIL	Groundislava	Maybe Too Cool	Tim Mantle/Psalm37
125	Light House GIL	Groundislava	Pluck your keys	Tim Mantle/Psalm37
126	Sendai GIL	Groundislava	Reminiscent	Tim Mantle/Psalm37
127	Sp. Beam Cannon	Groundislava	Shadow Industry	Tim Mantle/Psalm37

Patch No.	Single Patches – Bank C		Single Patches – Bank D	
	Patch Name	Created by	Patch Name	Created by
0	Ponderosa	Legowelt	Init Patch	
1	Evening Light	Legowelt	Init Patch	
2	Star Simulator	Legowelt	Init Patch	
3	Telcom Splendor	Legowelt	Init Patch	
4	Raw Deal	Legowelt	Init Patch	
5	Sesqua Valley	Legowelt	Init Patch	
6	Cobra Duobass	Legowelt	Init Patch	
7	Nomad Ninja	Legowelt	Init Patch	
8	Sequenchoco	Legowelt	Init Patch	
9	Nam Flashback	Legowelt	Init Patch	
10	Druid Music	Legowelt	Init Patch	
11	Space Giraffe	Legowelt	Init Patch	
12	Emerald Cascade	Legowelt	Init Patch	
13	Seafax Museum	Legowelt	Init Patch	
14	Memory X Bass	Legowelt	Init Patch	
15	Marin Pad	Legowelt	Init Patch	
16	Olympius	Legowelt	Init Patch	
17	Spacejazz Ranger	Legowelt	Init Patch	
18	Analog Speedo	Legowelt	Init Patch	
19	Simple Things	Legowelt	Init Patch	
20	British Ambient	Legowelt	Init Patch	
21	Artic Liqorish	Legowelt	Init Patch	
22	Ravens Jazz	Legowelt	Init Patch	
23	Nite Critters	Legowelt	Init Patch	
24	Feed Me Wavesap	Legowelt	Init Patch	
25	Welsh Synthesis	Legowelt	Init Patch	
26	Candy Rainfall	Legowelt	Init Patch	
27	Bamoose Bass	Legowelt	Init Patch	
28	Ondes Messianen	Legowelt	Init Patch	
29	Silver Shamrock	Legowelt	Init Patch	
30	Parapoly 8000	Legowelt	Init Patch	
31	Wasabi Ghost	Legowelt	Init Patch	
32	Sprinkle Stars	Legowelt	Init Patch	
33	Rusty Soul	Legowelt	Init Patch	
34	Tamboura Rays	Legowelt	Init Patch	
35	Oxford Dreams	Legowelt	Init Patch	
36	Ural Myst	Legowelt	Init Patch	
37	Ambient Sockshop	Legowelt	Init Patch	
38	Thera Tears	Legowelt	Init Patch	
39	Eomius Belay	Legowelt	Init Patch	
40	Fantasoba	Legowelt	Init Patch	
41	Steadybass Flute	Legowelt	Init Patch	
42	New Age Marina	Legowelt	Init Patch	
43	Side By Side	Legowelt	Init Patch	
44	Glory Jam	Legowelt	Init Patch	
45	Radiance Of Lite	Legowelt	Init Patch	
46	Big Splash Snug	Legowelt	Init Patch	
47	Einstein Strand	Legowelt	Init Patch	
48	TapeWave Infloop	Legowelt	Init Patch	
49	Jezebel	Legowelt	Init Patch	
50	Wyoming LSD	Legowelt	Init Patch	
51	Rain Shadow VIP	Legowelt	Init Patch	
52	Computer Day	Legowelt	Init Patch	
53	Valaxtica	Legowelt	Init Patch	
54	Manta Day	Legowelt	Init Patch	
55	Hypno Envelope	Legowelt	Init Patch	
56	Caramelbass	Legowelt	Init Patch	
57	Nine Gates	Legowelt	Init Patch	

58	Alpensynposium	Legowelt	Init Patch	
59	Jimi Patch	Legowelt	Init Patch	
60	Bodega Bay	Legowelt	Init Patch	
61	Season 3 Bass	Legowelt	Init Patch	
62	Duneman	Legowelt	Init Patch	
63	Parapoly Saw 700	Legowelt	Init Patch	
64	Analog Jazz EP	Legowelt	Init Patch	
65	Starlooper	Legowelt	Init Patch	
66	PennyWaffle Sa8	Legowelt	Init Patch	
67	Napa Breeze	Legowelt	Init Patch	
68	Synth Marmalade	Legowelt	Init Patch	
69	Lion Figurine	Legowelt	Init Patch	
70	Haddonfield	Legowelt	Init Patch	
71	Shetland Pony	Legowelt	Init Patch	
72	Historical Orleo	Legowelt	Init Patch	
73	Lizard Breath	Legowelt	Init Patch	
74	Modestoharpsi	Legowelt	Init Patch	
75	AeonBass	Legowelt	Init Patch	
76	Sinistrone Soup	Legowelt	Init Patch	
77	Fadango Vampy	Legowelt	Init Patch	
78	Katjesdrop	Legowelt	Init Patch	
79	Socour Overcast	Legowelt	Init Patch	
80	Arparoma	Legowelt	Init Patch	
81	Golden Age	Legowelt	Init Patch	
82	South Pacific	Legowelt	Init Patch	
83	Desert Bus	Legowelt	Init Patch	
84	Xenomurf	Legowelt	Init Patch	
85	Icepalace	Legowelt	Init Patch	
86	Wave Dew	Legowelt	Init Patch	
87	Oxford Manor	Legowelt	Init Patch	
88	Elvenmeadow	Legowelt	Init Patch	
89	Majestic Wolharp	Legowelt	Init Patch	
90	Grand CanyonPad	Legowelt	Init Patch	
91	Moddervet	Legowelt	Init Patch	
92	Island Astronomy	Legowelt	Init Patch	
93	Rigoheim	Legowelt	Init Patch	
94	Lazybass	Legowelt	Init Patch	
95	Swamp Satyr	Legowelt	Init Patch	
96	Americana	Legowelt	Init Patch	
97	Dream Plants	Legowelt	Init Patch	
98	Solarius	Legowelt	Init Patch	
99	Hyperborean Orca	Legowelt	Init Patch	
100	OxoAcid Oz	Legowelt	Init Patch	
101	VipeBuzz Big	Legowelt	Init Patch	
102	Atmy Synt	Legowelt	Init Patch	
103	Edensynt Seq	Legowelt	Init Patch	
104	Moondust	Legowelt	Init Patch	
105	Oervogel	Legowelt	Init Patch	
106	Emotional Wealth	Legowelt	Init Patch	
107	Castles	Legowelt	Init Patch	
108	Smolzazia pad	Legowelt	Init Patch	
109	Square Galapagos	Legowelt	Init Patch	
110	Faroer Ichiban	Legowelt	Init Patch	
111	Trip Cat	Legowelt	Init Patch	
112	Mystery Coast	Legowelt	Init Patch	
113	Mixtur Trautoni	Legowelt	Init Patch	
114	lima Lama	Legowelt	Init Patch	
115	Ambi Sludge Pro	Legowelt	Init Patch	
116	Sweet Acid Seq	Legowelt	Init Patch	
117	Juniper	Legowelt	Init Patch	

118	Winter Shore	Legowelt	Init Patch	
119	QuicksilverPudi	Legowelt	Init Patch	
120	Norycove Harpsi	Legowelt	Init Patch	
121	LAQidayS	Legowelt	Init Patch	
122	Lifespan 75	Legowelt	Init Patch	
123	Niteowl	Legowelt	Init Patch	
124	Millenia	Legowelt	Init Patch	
125	TV Detective	Legowelt	Init Patch	
126	Mesc Uni Drums	Legowelt	Init Patch	
127	P.O. BOX Space	Legowelt	Init Patch	

Patch No.	Multi Patches - Bank A		Multi Patches - Bank B	
	Patch Name	Created by	Patch Name	Created by
0	FM Singularity	Gforce Software	Dream Stance	Alex Jann
1	Buzzy Brass	Enrico Cosimi	Eighties Brass	Enrico Cosimi
2	Bored of Canada	Gforce Software	Portal	Patricia Wolf
3	Alluvial	r Beny	Movement Above	Inhalt
4	FM Bell Layer	Inhalt	FM Piano & Pad	Enrico Cosimi
5	Gas Valves	Peter Dyer	Cyanide Sister	Peter Dyer
6	Puzzlebox GIL	Groundislava	Expanding Heads	Gforce Software
7	Dream Gazing	Tim Mantle / Psalm37	Warehouse Shapes	Tim Mantle / Psalm37
8	Tape Choir	Gforce Software	Imperfect 5ths	Gforce Software
9	Infinite Power	Inhalt	Italo Split	Inhalt
10	Cornish Pie	Legowelt	Bell Ensemble	Groundislava
11	Dark Funk Haven	Legowelt	Bubble Skyline	Groundislava
12	Deep Sea Jazz	Legowelt	Claw Bass GIL	Groundislava
13	Desert Springs	Legowelt	Damp Night GIL	Groundislava
14	Donker Moraes	Legowelt	Dark Planet GIL	Groundislava
15	Film Noir	Legowelt	Dark Funk Heaven	Groundislava
16	Florida Mallsad	Legowelt	Full Spectrum	Groundislava
17	Flying Boards	Legowelt	Hand of Midas	Groundislava
18	Night Mood	Legowelt	Mossy Log GIL	Groundislava
19	Outer Aegis	Legowelt	Plasma Battery	Groundislava
20	Pattern Bay	Legowelt	Rift Stone GIL	Groundislava
21	Pensive Planets	Legowelt	Sparklizer GIL	Groundislava
22	Puppy Hotel	Legowelt	Stone Organ GIL	Groundislava
23	Saturated Hues	Legowelt	Temple Depths	Groundislava
24	SID PWM & Poly	Legowelt	Tube World GIL	Groundislava
25	Spacial Experts	Legowelt	Tunnel Bass GIL	Groundislava
26	Spirited Moose	Legowelt	Twilight GIL	Groundislava
27	Tape Delay Jazz	Legowelt	Visual Light GIL	Groundislava
28	Twirly Mallets	Legowelt	Warm Wind GIL	Groundislava
29	Vampirion	Legowelt	Abyssal	r Beny
30	Vetbass & Cosmos	Legowelt	Algae	r Beny
31	6 Osc Bass	Gforce Software	Aurora Pockets	r Beny
32	80s Electro	Gforce Software	Belloma	r Beny
33	Anointed Poly	Gforce Software	Carl'stapes	r Beny
34	Arp & Wavetable	Gforce Software	Cedar	r Beny
35	Arp Perc Pad	Gforce Software	Chrome Forest	r Beny
36	Arp Triplet	Gforce Software	City Maps	r Beny
37	Arps Everywhere	Gforce Software	Fjossa	r Beny
38	Bass & Pad Synth	Gforce Software	Glass Bird	r Beny
39	Bass/Wurly C#3	Gforce Software	Iguana and Bee	r Beny
40	Bell Waves	Gforce Software	Kaleidaharp	r Beny
41	Big (-_-) Poly	Gforce Software	Kitro	r Beny
42	Blades of Fire	Gforce Software	Opal	r Beny
43	ChimEpad	Gforce Software	Pond	r Beny
44	Dirty Wiper	Gforce Software	Rivulet	r Beny
45	Dub Keys	Gforce Software	Seasick	r Beny
46	Echo Keys	Gforce Software	Sea Song	r Beny
47	Epic Start	Gforce Software	Sequoia	r Beny
48	Film Score Epic	Gforce Software	To The Wind	r Beny
49	Formant Peaks	Gforce Software	Animus	Peter Dyer
50	Funk Split	Gforce Software	Big Dreams	Peter Dyer
51	Hi Ya Nisqatsi	Gforce Software	Bubble Maker	Peter Dyer
52	Humana Vox	Gforce Software	Candy Machine	Peter Dyer
53	I Hear U Jon	Gforce Software	Chop Saw	Peter Dyer
54	LA Saccharinth	Gforce Software	Cloud Cover	Peter Dyer
55	Loving Chord	Gforce Software	Coast Clavier	Peter Dyer
56	Loving The Arps	Gforce Software	Coasting	Peter Dyer
57	Lymphadenopathy	Gforce Software	Cookie Cilffs	Peter Dyer

58	Mid C Pattern	Gforce Software	Cotton Candy	Peter Dyer
59	Moody Pad	Gforce Software	Drift On	Peter Dyer
60	Noise Nirvana	Gforce Software	Easy Bop	Peter Dyer
61	NuovaChord	Gforce Software	Flight Path	Peter Dyer
62	Octaves & Fifths	Gforce Software	Floating Lanterns	Peter Dyer
63	Pad & Lead 1	Gforce Software	Foam Chord	Peter Dyer
64	Pad & Lead 2	Gforce Software	Goose Bumps	Peter Dyer
65	Phased Delight	Gforce Software	Gulf Winds	Peter Dyer
66	Pick a Pad	Gforce Software	Horizon Bounce	Peter Dyer
67	Plucka Bed	Gforce Software	Night Crime	Peter Dyer
68	Plucket Again	Gforce Software	Old Friends	Peter Dyer
69	PoWeR SiNthesist	Gforce Software	Pacific By Way	Peter Dyer
70	Red Alert!	Gforce Software	Plunker	Peter Dyer
71	Refractions	Gforce Software	Pomp Comp	Peter Dyer
72	Ricochet Pad	Gforce Software	Power Suit	Peter Dyer
73	Rise & Flutter	Gforce Software	Pump up	Peter Dyer
74	Romford Tecno 90	Gforce Software	RAM Flow	Peter Dyer
75	Seismic Lights	Gforce Software	Researching	Peter Dyer
76	Shifting Sands	Gforce Software	Riggles	Peter Dyer
77	Space Cadet	Gforce Software	Shoreline	Peter Dyer
78	Spiked	Gforce Software	Social Funk	Peter Dyer
79	Strings Octaves	Gforce Software	Speedish House	Peter Dyer
80	Stringy Fifths	Gforce Software	Start Screen	Peter Dyer
81	Super Chord	Gforce Software	The Forge	Peter Dyer
82	Super Nasty Lead	Gforce Software	The Orishas	Peter Dyer
83	Sync Clasher	Gforce Software	Tight Walk	Peter Dyer
84	Triumphant	Gforce Software	Vice City	Peter Dyer
85	Tyrell Brass	Gforce Software	Wild & Loose	Peter Dyer
86	Uni Bass & Poly	Gforce Software	Zeus Fanfare	Peter Dyer
87	Wind Staccato	Gforce Software	Alva Bass Pile	Inhalt
88	Windy Pad	Gforce Software	PolySummit Choir	Inhalt
89	Wurly\Lead C3	Gforce Software	Astral Duves	Inhalt
90	80s String Unit	Tim Mantle / Psalm37	Big EP	Inhalt
91	Back Catalogue	Tim Mantle / Psalm37	Big Romance	Inhalt
92	Brass for Days!	Tim Mantle / Psalm37	Cabaret Vol Spit	Inhalt
93	Carrillon Matron	Tim Mantle / Psalm37	City of Monica	Inhalt
94	Champs-Elysees	Tim Mantle / Psalm37	Cocteau1 Hour	Inhalt
95	Clingerclang	Tim Mantle / Psalm37	Covenant Split	Inhalt
96	Coming Abroad	Tim Mantle / Psalm37	Digistalgia Splt	Inhalt
97	Discovery Layer	Tim Mantle / Psalm37	Dueling Arps	Inhalt
98	Dust Down Love	Tim Mantle / Psalm37	Dyno My Piano	Inhalt
99	EP P37	Tim Mantle / Psalm37	FM AM Split	Inhalt
100	Escape Pod	Tim Mantle / Psalm37	FSOLos Angeles	Inhalt
101	Faux Century	Tim Mantle / Psalm37	Instant Intro	Inhalt
102	For Her Genius	Tim Mantle / Psalm37	Last Train	Inhalt
103	Fruit Picking	Tim Mantle / Psalm37	Liquid Stack	Inhalt
104	Fully Loaded	Tim Mantle / Psalm37	Massiv Strings	Inhalt
105	Grey's Abduction	Tim Mantle / Psalm37	McBride's Cave	Inhalt
106	Guilty Pleasures	Tim Mantle / Psalm37	Mifgr's Split	Inhalt
107	Hardcore Score	Tim Mantle / Psalm37	Neologic split	Inhalt
108	Legacy Lead	Tim Mantle / Psalm37	Orange Chariots	Inhalt
109	Long Gone	Tim Mantle / Psalm37	Oranic	Inhalt
110	Mercury	Tim Mantle / Psalm37	Phantasia 2020	Inhalt
111	Nil by Mouth	Tim Mantle / Psalm37	Pleasure Quest	Inhalt
112	Panuc Stations	Tim Mantle / Psalm37	Pop Composer	Inhalt
113	Regeneration	Tim Mantle / Psalm37	Recombinant Mlab	Inhalt
114	Remember Fusion	Tim Mantle / Psalm37	Start The Rave	Inhalt
115	Revised Hope	Tim Mantle / Psalm37	Sunrise Summit	Inhalt
116	Slick & Trick	Tim Mantle / Psalm37	Thorny	Inhalt
117	Small Town USA	Tim Mantle / Psalm37	Unicorn Dreams	Inhalt

118	Spectral Helper	Tim Mantle / Psalm37	Uno Linear Split	Inhalt
119	Stock-Ex Montage	Tim Mantle / Psalm37	Violated	Inhalt
120	Such a Charmer!	Tim Mantle / Psalm37	Voice of Summit	Inhalt
121	That's the Jazz!	Tim Mantle / Psalm37	Vurtual Rain	Inhalt
122	The Good Stuff	Tim Mantle / Psalm37	Warm Games	Inhalt
123	Them Feels	Tim Mantle / Psalm37	West End Split	Inhalt
124	Toe Tap 2000	Tim Mantle / Psalm37	InTheGloaming	Tristan McGuire
125	Find And Forget	Tim Mantle / Psalm37	Kosmic Hope	Alex Jann
126	Was it a Dream	Tim Mantle / Psalm37	Strung Out	Alex Jann
127	We Must Hide!	Tim Mantle / Psalm37	Zen Orbit	Alex Jann

Patch No.	Multi Patches – Bank C		Multi Patches – Bank D	
	Patch Name	Created by	Patch Name	Created by
0	Alchemy	Patricia Wolf	Init Multi	
1	Anthromorphize	Patricia Wolf	Init Multi	
2	Anticipation	Patricia Wolf	Init Multi	
3	Aquatic Paradise	Patricia Wolf	Init Multi	
4	Aurora Borealis	Patricia Wolf	Init Multi	
5	Cascade	Patricia Wolf	Init Multi	
6	Chasm	Patricia Wolf	Init Multi	
7	Childhood Memory	Patricia Wolf	Init Multi	
8	Chimera	Patricia Wolf	Init Multi	
9	Clandestine	Patricia Wolf	Init Multi	
10	Cloud Hopping	Patricia Wolf	Init Multi	
11	Clouds Pass By	Patricia Wolf	Init Multi	
12	Crystal Lattice	Patricia Wolf	Init Multi	
13	Day Dream	Patricia Wolf	Init Multi	
14	Degraded Tape	Patricia Wolf	Init Multi	
15	Desert Sunset	Patricia Wolf	Init Multi	
16	Electric Company	Patricia Wolf	Init Multi	
17	Euphoria	Patricia Wolf	Init Multi	
18	Fairyland	Patricia Wolf	Init Multi	
19	Falling Water	Patricia Wolf	Init Multi	
20	first Kiss	Patricia Wolf	Init Multi	
21	First Saw You	Patricia Wolf	Init Multi	
22	Fond Memory	Patricia Wolf	Init Multi	
23	Frozen Lake	Patricia Wolf	Init Multi	
24	If You Believe	Patricia Wolf	Init Multi	
25	In Your Head	Patricia Wolf	Init Multi	
26	Introspection	Patricia Wolf	Init Multi	
27	Ionic Bond	Patricia Wolf	Init Multi	
28	Lady Bug	Patricia Wolf	Init Multi	
29	Last Dance	Patricia Wolf	Init Multi	
30	Longing	Patricia Wolf	Init Multi	
31	Magic Pool	Patricia Wolf	Init Multi	
32	Magic Sword	Patricia Wolf	Init Multi	
33	Memory	Patricia Wolf	Init Multi	
34	Mercury	Patricia Wolf	Init Multi	
35	Metal Music	Patricia Wolf	Init Multi	
36	Molten Core	Patricia Wolf	Init Multi	
37	Moonlit Lake	Patricia Wolf	Init Multi	
38	Morning Light	Patricia Wolf	Init Multi	
39	Noble Cause	Patricia Wolf	Init Multi	
40	Obstacle	Patricia Wolf	Init Multi	
41	Quiet Guitar	Patricia Wolf	Init Multi	
42	Racing Dolphins	Patricia Wolf	Init Multi	
43	Rock Face	Patricia Wolf	Init Multi	
44	Scrambled	Patricia Wolf	Init Multi	
45	Secret Meeting	Patricia Wolf	Init Multi	
46	Secret Mission	Patricia Wolf	Init Multi	
47	Shimmer	Patricia Wolf	Init Multi	
48	Snowy Owl	Patricia Wolf	Init Multi	
49	Soaring	Patricia Wolf	Init Multi	
50	Star Gazing	Patricia Wolf	Init Multi	
51	Strong Along	Patricia Wolf	Init Multi	
52	Sundown Arp	Patricia Wolf	Init Multi	
53	Suspense	Patricia Wolf	Init Multi	
54	The Weaver	Patricia Wolf	Init Multi	
55	Tranquil Water	Patricia Wolf	Init Multi	
56	Tundra	Patricia Wolf	Init Multi	
57	Urban Decay	Patricia Wolf	Init Multi	

58	Water Dragon	Patricia Wolf	Init Multi	
59	Wild Horses	Patricia Wolf	Init Multi	
60	Windswept	Patricia Wolf	Init Multi	
61	Winged Migration	Patricia Wolf	Init Multi	
62	Call and Action DN	Danny Nugent	Init Multi	
63	Aggro Poly	Enrico Cosimi	Init Multi	
64	Altered Arpeggio	Enrico Cosimi	Init Multi	
65	Altered State	Enrico Cosimi	Init Multi	
66	Arp & SyncLead	Enrico Cosimi	Init Multi	
67	Bass & MellwLead	Enrico Cosimi	Init Multi	
68	Bass & Organ	Enrico Cosimi	Init Multi	
69	Bass & Pad	Enrico Cosimi	Init Multi	
70	Bass & Prog Lead	Enrico Cosimi	Init Multi	
71	Big Stab	Enrico Cosimi	Init Multi	
72	Bouncing Pad	Enrico Cosimi	Init Multi	
73	Bravo Delta Arp	Enrico Cosimi	Init Multi	
74	Charlie & Pad	Enrico Cosimi	Init Multi	
75	Charlie Delta 2Arp	Enrico Cosimi	Init Multi	
76	Dawn	Enrico Cosimi	Init Multi	
77	Deceleration	Enrico Cosimi	Init Multi	
78	Dirdir	Enrico Cosimi	Init Multi	
79	Drone Arpeggio	Enrico Cosimi	Init Multi	
80	DynaDecelerated	Enrico Cosimi	Init Multi	
81	Epic	Enrico Cosimi	Init Multi	
82	FM Percuss Pad	Enrico Cosimi	Init Multi	
83	Frozen Motion	Enrico Cosimi	Init Multi	
84	Karabas	Enrico Cosimi	Init Multi	
85	Kick & Snare	Enrico Cosimi	Init Multi	
86	Layer Bass	Enrico Cosimi	Init Multi	
87	Layer Pad	Enrico Cosimi	Init Multi	
88	Moving Stab	Enrico Cosimi	Init Multi	
89	Nigth Time	Enrico Cosimi	Init Multi	
90	Out There	Enrico Cosimi	Init Multi	
91	Separated Octave	Enrico Cosimi	Init Multi	
92	Seq Friendly	Enrico Cosimi	Init Multi	
93	Silk Pad	Enrico Cosimi	Init Multi	
94	The Chase	Enrico Cosimi	Init Multi	
95	Two Friends	Enrico Cosimi	Init Multi	
96	Window Tears	Chris Calcutt - aka CALC	Init Multi	
97	Leave The Latch	Chris Calcutt - aka CALC	Init Multi	
98	Bass Chords	Chris Calcutt - aka CALC	Init Multi	
99	Bubbling Vista	Chris Calcutt - aka CALC	Init Multi	
100	Wooden Bridge	Chris Calcutt - aka CALC	Init Multi	
101	Sustenance	Chris Calcutt - aka CALC	Init Multi	
102	Pree Yrself	Chris Calcutt - aka CALC	Init Multi	
103	Mechanical Pill	Chris Calcutt - aka CALC	Init Multi	
104	Fuzzy Logic	Chris Calcutt - aka CALC	Init Multi	
105	Instant Darkroom	Chris Calcutt - aka CALC	Init Multi	
106	Bastian Machine	Chris Calcutt - aka CALC	Init Multi	
107	Not Really Brass	Chris Calcutt - aka CALC	Init Multi	
108	Smoke The Pipe	Chris Calcutt - aka CALC	Init Multi	
109	80s Rolled Sleev	Chris Calcutt - aka CALC	Init Multi	
110	Split Creamola	Chris Calcutt - aka CALC	Init Multi	
111	Crustacian	Chris Calcutt - aka CALC	Init Multi	
112	Gristling Throb	Chris Calcutt - aka CALC	Init Multi	
113	Fresh Milk	Chris Calcutt - aka CALC	Init Multi	
114	Wired Harmonium	Chris Calcutt - aka CALC	Init Multi	
115	Tree Lined Walk	Chris Calcutt - aka CALC	Init Multi	
116	Slow Arp DN	Danny Nugent	Init Multi	
117	Puhu	Jerome Meunier	Init Multi	

118	/_\	Jerome Meunier	Init Multi	
119	Nara	Jerome Meunier	Init Multi	
120	Kona	Jerome Meunier	Init Multi	
121	Hold	Jerome Meunier	Init Multi	
122	Alba	Jerome Meunier	Init Multi	
123	Lima	Jerome Meunier	Init Multi	
124	Petit Chat	Jerome Meunier	Init Multi	
125	EM	Jerome Meunier	Init Multi	
126	Jima	Jerome Meunier	Init Multi	
127	Miya	Jerome Meunier	Init Multi	

