

RAKOSO

HA400

User's Manual



Network 4 Zone Amplifier

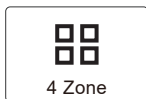

Table of Contents

1. Introduction	1
2. System Requirements	1
3. What's in The Box	2
3.1 Front Panel	3
3.2 Back Panel	3
3.3 Side Panel	4
4. Placing Your HA400.....	4
5. Zone Connection	5
5.1 Connect Your Speakers.....	5
5.2 Connect to External Amplifier or AV Receiver	6
5.3 Connect to External Subwoofer.....	6
5.4 Connect to USB Storage Device	7
5.5 Connect to Audio Playback Device	7
5.6 RS232 Serial Port	8
5.7 Connect to Network	8
6. Download 4Stream APP	9
7. Using HA400	9
7.1 Selecting a ZONE.....	9
7.2 Play Same Music to Multiple Rooms.....	10
7.3 Listen to Online Music	11
7.4 Spotify.....	11
7.5 Airplay2.....	11
7.6 Qplay	11
7.7 Listen to Local Music.....	11
7.8 Music Playlist.....	12
7.9 Play Music From Line In.....	12
7.10 Play Music From Optical/Coaxial in.....	12
7.11 Play Music From PC.....	12
7.12 Changing Output Channels	12
7.13 Device Settings.....	13
8. Firmware Update	14
9. Specification	14
FCC	15
FAQ	16

1. Introduction

HA400 is a multi-room system that enables you to enjoy your favorite music anywhere in your home. HA400 contains 4 audio amplifiers for you to connect to 4 set of stereo speakers. Each zone also contains analog and digital audio outputs for you to use as audio source. You can easily play music from online music services, your phone storage, NAS and other sources by using the 4Stream app on your iOS or Android device.

- **Amplification:** Each zone can provide 50Wx2@8ohms (stereo mode) or 100W@4ohms (bridge mode)
- **Multi-room audio function:** Play different songs in different rooms or same song in every room.
- **Easy network setup:** Connect to your home network and it is ready to use.
- **Rich I/O interface:** Each zone has separate digital input/output and analog input/output. There is also a master source input that all zones can used at the same time.

2. System Requirements

High Speed Internet Connection:

HA400 needs internet connection to stream music from online music services and to get online firmware updates. You may experience performance issues with slower internet connections.

Wireless Router:

In order to use HA400, you will need to have a working Wi-Fi network in your home, since the control APP on your mobile device need to be in the same network as the streamer.

Control APP – 4Stream:

You can control HA400 using our free 4Stream app on any iOS and Android device that meets these minimum requirements:



3. What's in The Box

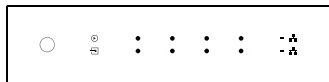

HA400



User's Manual

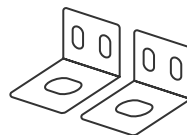

Rack Mount Brackets x2



Power Cable

3.1 Front Panel

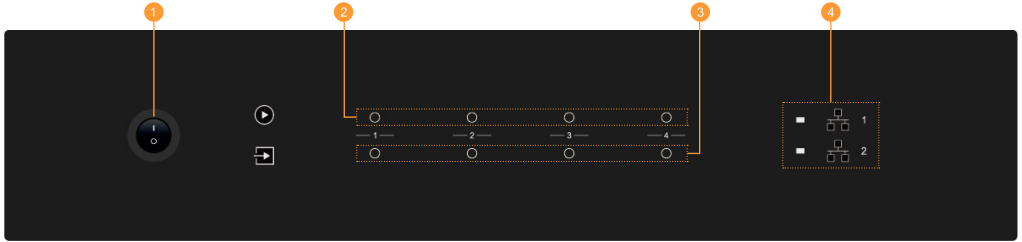

- 1 Power Button
- 2 Streaming Indicator – LED on when streaming.
- 3 Input Source Indicator – LED Color: White for Network Audio, Green for Line in 1 (Zone Line in), Yellow for Line in 2 (Master Line in), Magenta for Master Optical in, Cyan for Master Coaxial in, Red for USB.
- 4 Network Indicators – LED on when network is available.

3.2 Back Panel

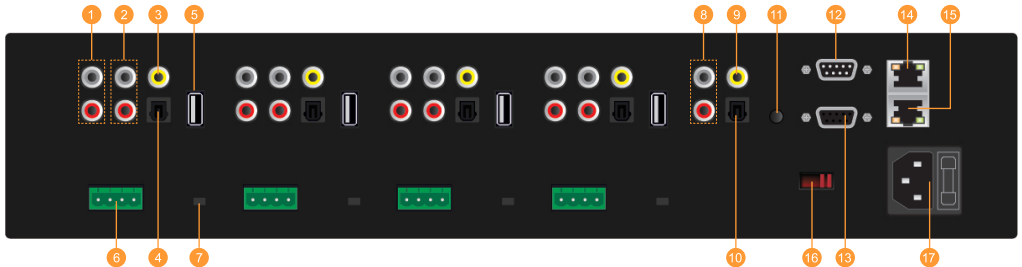

- 1 Pre-Out
- 2 Line in (Line 1 in APP)
- 3 Digital Coaxial Out
- 4 Digital Optical In
- 5 USB port
- 6 Speaker out
- 7 Stereo/Bridge mode switch
- 8 Master Line In
- 9 Master Coaxial In
- 10 Master Optical In
- 11 Reset Button
- 12 RS232 Pass Through Port
- 13 RS232 Port
- 14 Network Output
- 15 Network Input
- 16 Voltage Selection Switch (115V/230V)
- 17 Power Plug

3.3 Side Panel

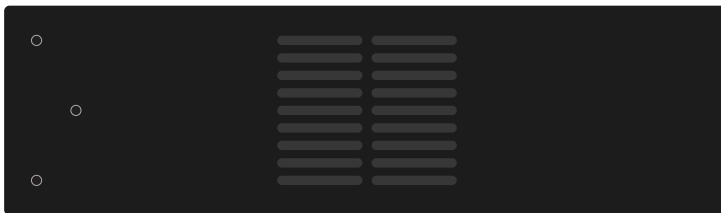

Screw holes for mounting brackets

4. Placing your HA400

HA400 size is standard 2U size, you can easily install into an equipment rack. Attached the included rack mounting brackets on each side of HA400 if you want to mount it on to a standard EIA equipment rack.

-- Align the rack mounting brackets with the screw holes on the side and screw in the screws tightly.

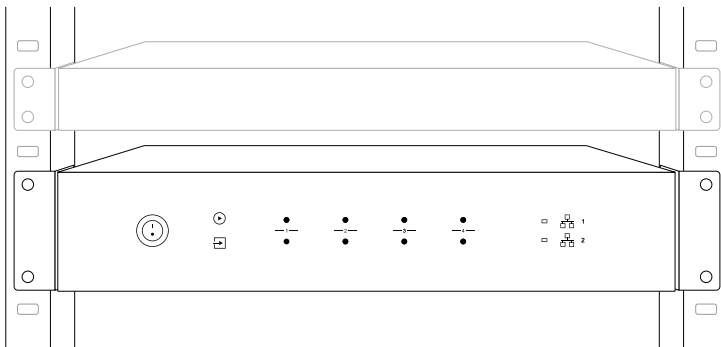

5. Zone Connection

You can play the same audio source in all four zone at the same time, you can also play different audio sources in different zones.

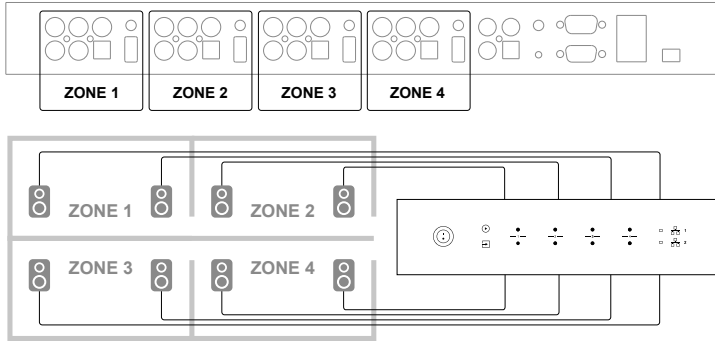

5.1 Connect Your Speakers

Connect your stereo speaker to the speaker output using the phoenix connector. You can also switch to Bridge mode (BR) to connect to a Mono speaker.

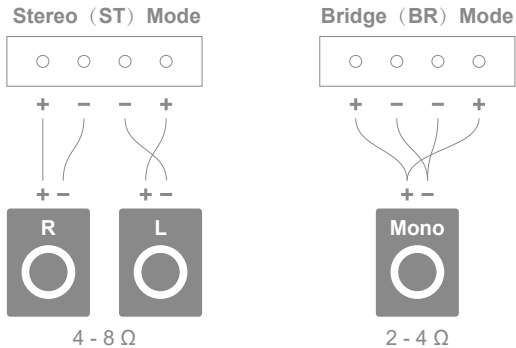

5.2 Connect to External Amplifier or AV Receiver

Connect the LINE OUT output to the input on your amplifier or AV receiver using the appropriate cable. HA400 supports both analog output (RCA) and digital output (Coaxial).

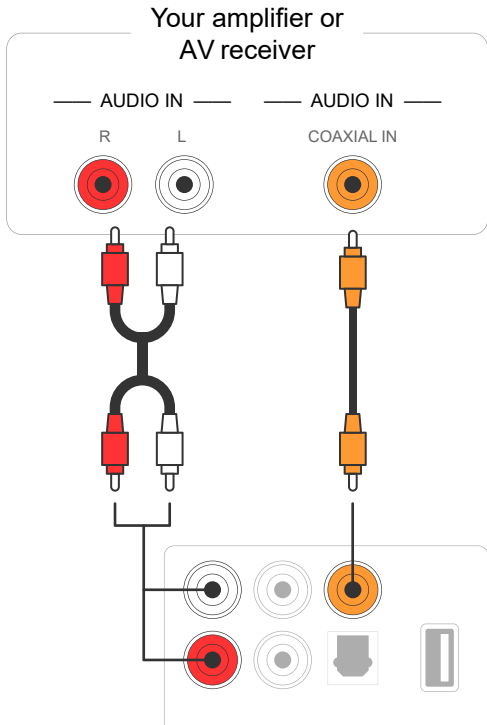

5.3 Connect to External Subwoofer

Connect the LINE OUT "L" output to the input on your active subwoofer or subwoofer amplifier.

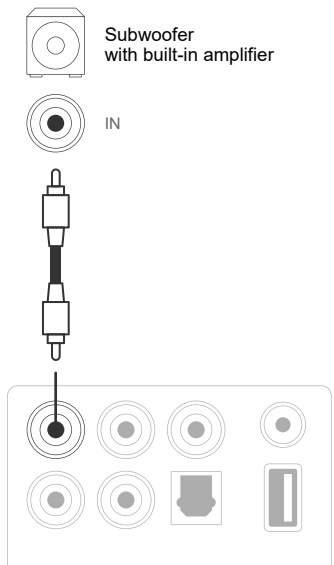

5.4 Connect to USB Storage Device

To play music stored in a USB storage device, just plugin a USB storage device containing music files to the USB port of the Zone you want to play with.

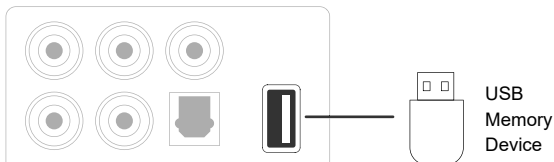

5.5 Connect to Audio Playback Device

Connect the LINE IN, OPTICAL IN in each zone or LINE IN, COAXIAL IN, OPTICAL IN in the master input area to an audio playback device, it can be a CD player, portable music player or any device with audio output using the same connector.

In the APP, LINE IN in each zone is represent as Line in, LINE IN in the master input area is represent as AUX. Optical IN in each zone is represent as OPT1, Optical IN and Coaxial IN in the master input area is represent as OPT2 and COX.

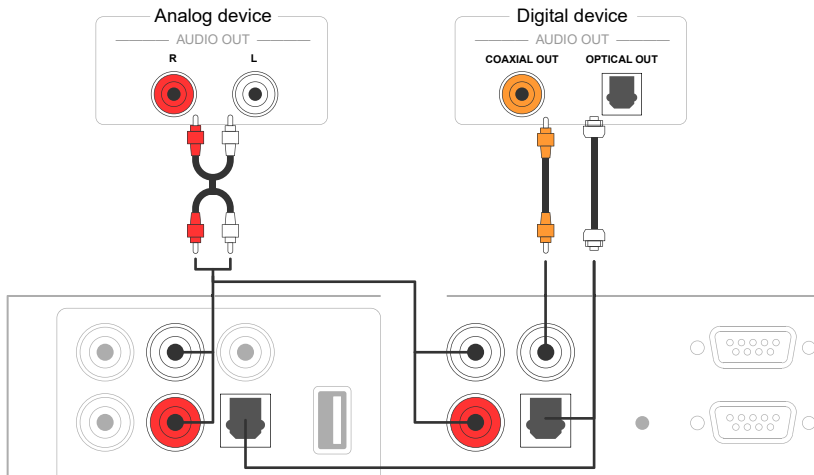

5.6 RS232 Serial Port

RS232 serial port is reserved for connection to smart home control unit to control HA400. You can use the Pass-Through port to connect to another HA400 for group control.

5.7 Connect to Network

Connect HA400 to your home router using a LAN cable to add it into your home network. You can use the NETWORK OUT port to connect another device to the same network.

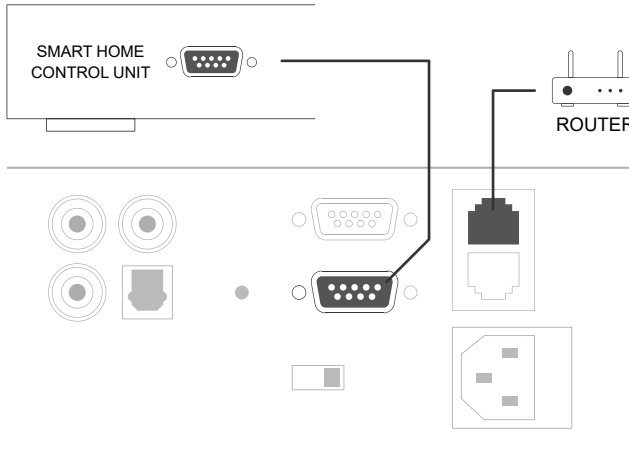

6. Download 4Stream APP

The 4Stream APP is the controller of the whole system. Install 4Stream APP in your mobile device and you can control and stream music anywhere in your home.

The application supports English, Spanish, French, German, Italian, Portuguese, Korean, Simplified Chinese, Traditional Chinese and Japanese.

You can download 4Stream App for iOS or Android by searching "4Stream" in App Store or Google Play.



7. Using HA400

Once you have connected your HA400 to your network and install 4Stream app in your mobile device, you can start playing music to different rooms. You can listen to different music in different room or the same music in all rooms in sync.

7.1 Selecting a ZONE

In 4Stream APP you will see all the connected devices in the same network.

1. Select the device you want to control, the selected device will have a green bar appears on the left side.
2. Swap to the left to open the list of music sources.
3. Select an online or local music source from the list to start streaming your music.

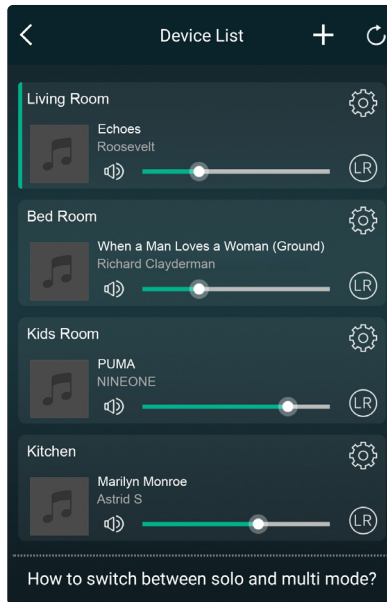

7.2 Play Same Music to Multiple Rooms

You can play the same music to multiple rooms simultaneously by adding other devices to form a group by pressing the “” icon beside the device. This device will be the master device, the music stream to the master device will also playback on other devices in the same group.

If you want to stream to multiple devices using Airplay2, you can just add the zones you want when you select device in airplay2 interface. If your music source is from Airplay2, this is the only method you can stream the same music to multiple devices.

If your music source is from the master source input, there is no need to group the devices, since all the devices can access the master source input.

*There will be a small delay between the audio source and the 4 zones when in multizone mode, all 4 zones will be in sync with no delay between them.

*There is no delay when you use the master source input as input source for the 4 zones. No need to group them together, ungroup them to play in sync with the input source.

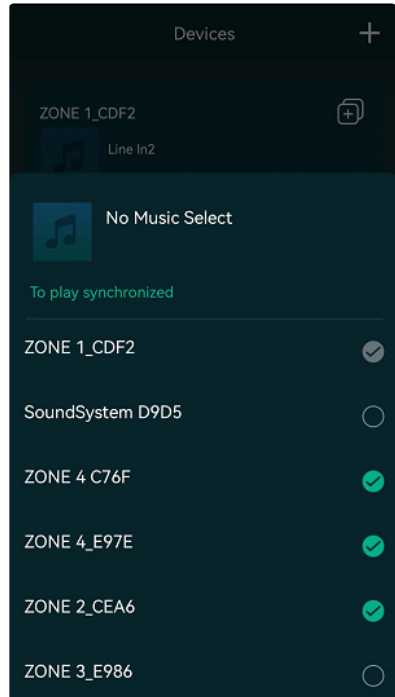

7.3 Listen to Online Music

HA400 can work with famous online streaming music services like Spotify, Tidal, Qobuz, Deezer, Amazon Music, QQ Music, Tuneln, Internet radio, iHeartradio. You can easily stream music or playlist from your account wirelessly and play on your home audio system.

7.4 Spotify

To use Spotify, you need to have Spotify premium account. You will find the device in device list in Spotify application and choose the device you want to stream.

7.5 Airplay2

The device supports Airplay2, you can choose Airplay in iOS device and play music.

7.6 Qplay

The device supports QQ music using Qplay protocol, you need to turn on Qplay in QQ music application setting and then find the device in Qplay list

7.7 Listen to Local Music

HA400 can stream local music stored in your mobile phone, USB storage drive, NAS using DLNA protocol, PC software like itunes, or UPnP/DLNA 3rd party software.

Click on "My Music" to select the local device you want to play from.

Note: iOS based devices have blocked the access to iTunes library.

*Our system only supports NAS using DLNA protocol.

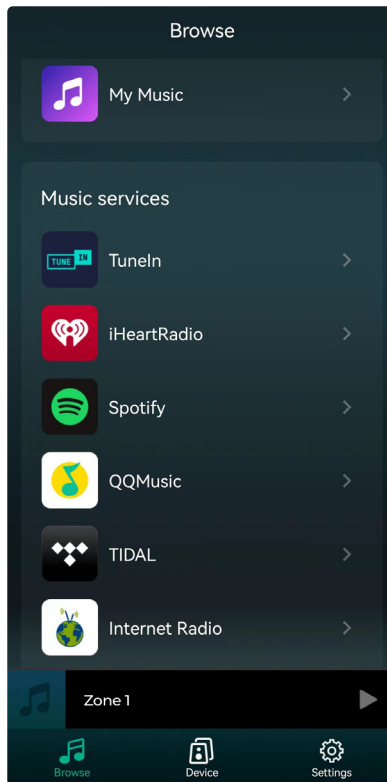

7.8 Music Playlist

You can create music playlist and add local music to the list for streaming.

7.9 Play Music From Line In

- Connect an external audio source to line-in port using RCA cable.
- Choose line in mode in the 4Stream application to switch to line in mode.
- Line in is the line in port of the current zone, AUX is the line in port Of the master input source.

7.10 Play Music From Optical/Coaxial In

- Connect an external audio source to Optical in of a zone or Optical, Coaxial in of the master input source.
- Choose OPT1 (zone), OPT2 (master) or COX in the 4Stream application to switch to the corresponding mode.

7.11 Play Music From PC

You can stream audio stored in your Mac and Windows PC by using iTunes, 3rd party UPnP/DLNA streaming program like Foobar2000, Music Bee or Serviio.

7.12 Changing Output Channels

You can change the output channel of the zone, you can change between Left channel only, Right channel only or Stereo. You can set Zone 1 to play Left channel and Zone 2 to play right channel, group them together to make stereo. By default it is set to Stereo.

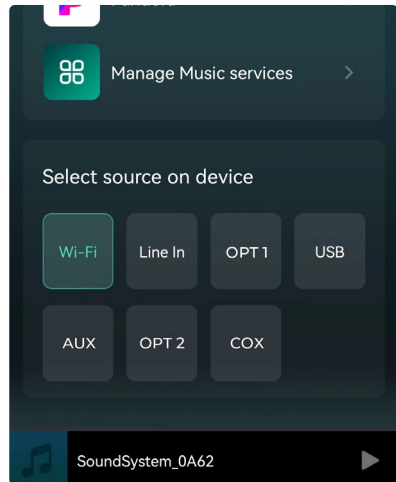
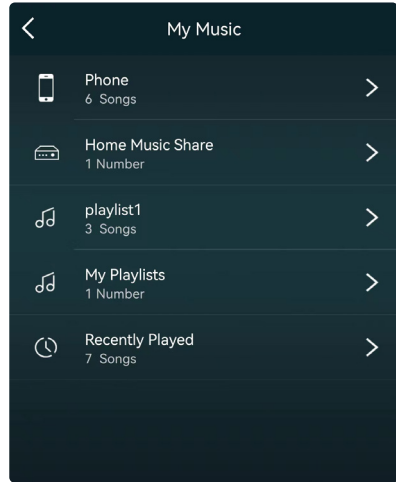

7.13 Device Settings

Rename: You can rename each zone to different name to fit your needs.

Speaker Info: You will see the device information like device's IP address, Device name, Firmware Version and Restore Factory Default.

Alarm Clock: Setup music alarm clock, music can choose from Preset list, internet radio, iHeartRadio, Napster, Tidal, Spotify, Deezer and NAS.

Preset Content: You can store 10 different playlist or radio station to the Preset list for quick access.

Any list or station with the speaker icon can be preset. Click on the speaker icon and you can assign it to the preset list.

Sleep Timer: Setup a Countdown timer to stop music.

EQ: You can control treble and bass of the device.

Restore Factory Settings: Long press the Reset button for 8 sec to restore the device to factory default settings. This will reset all the zone names, volume and current input source.

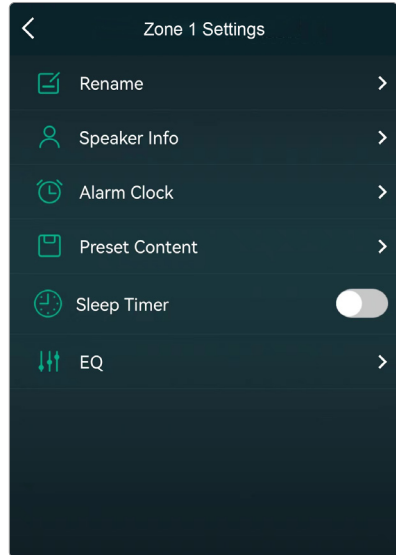

8. Firmware Update

Whenever a new firmware is available, you will be notified by a "new" icon. Click on the "new" icon to begin firmware update, it will take couple minutes.

It is recommended to update firmware when it is available, it might not only correct bugs or improve performance, but also might add new features or services.

9. Specification

4 Zone Audio I/O		
Audio Input	Line in	Max 2V RMS input
	Optical in	Max 192kHz/24bit sample rate decode PCM encoding
	USB	USB disk drive playback
Audio Output	Pre out	Max 2V RMS output
	Coaxial out	48kHz/16Bit output
	Speaker out	50W per channel @ 8ohms, Bridged Amplifier mode 100W @4ohms per channel
Master Input Source		
Audio Input	Line in	Max 2V RMS input
	Optical in	Max 192kHz/24bit sample rate decode PCM encoding
	Coaxial in	
Network		
Ethernet In	RJ45	Connect to internet
Ethernet Out	RJ45	Output to other device to share the network
Music Sources		
Streaming Protocol	Spotify Connect, Tidal Connect, Airplay2, DLNA, UPnP, Qplay	
Online Music	Spotify, Tidal, Deezer, Qobuz, Napster, Pandora, Amazon Music, Internet Radio, iHeartRadio, vTuner, QQ music, QQ FM	
Local Music	Mobile device music, NAS storage music files, USB disk drive music files	
Multizone function	1. By Master input source 2. By APP to setup one zone as master to sync music to other zone	
General		
Power	115-230V AC 50/60Hz	
Control Interface	Dual-way RS232	
Size	2U rack size	

FCC Statement:

Federal Communication Commission (FCC) Radiation Exposure Statement

When using the product, maintain a distance of 20cm from the body to ensure compliance with RF exposure requirements.

This device complies with part 15 of the FCC rules. Operation is subject to the following two conditions:

(1) this device may not cause harmful interference, and

(2) this device must accept any interference received, including interference that may cause undesired operation.

NOTE: The manufacturer is not responsible for any radio or TV interference caused by unauthorized modifications or changes to this equipment. Such modifications or changes could void the user's authority to operate the equipment.

NOTE: This equipment has been tested and found to comply with the limits for a Class B digital device, pursuant to part 15 of the FCC Rules. These limits are designed to provide reasonable protection against harmful interference in a residential installation. This equipment generates uses and can radiate radio frequency energy and, if not installed and used in accordance with the instructions, may cause harmful interference to radio communications. However, there is no guarantee that interference will not occur in a particular installation. If this equipment does cause harmful interference to radio or television reception, which can be determined by turning the equipment off and on, the user is encouraged to try to correct the interference by one or more of the following measures:

- Reorient or relocate the receiving antenna.
- Increase the separation between the equipment and receiver.
- Connect the equipment into an outlet on a circuit different from that to which the receiver is connected.
- Consult the dealer or an experienced radio/TV technician for help.

Spotify Software Third Party License:

The Spotify Software is subject to third party licenses found here:

<https://www.spotify.com/connect/third-party-license>

FAQ

Q: Do your devices support airplay and third-party DLNA apps?

A: Yes. They support airplay and third-party apps like MusicBee, Foobar2000.

Q: How many zones can you group in one system?

A: 12 rooms is the maximum, while 8 zones are recommended.

Q: What distance can your wireless audio system cover?

A: Once the system is connected to your WiFi router, you can stream your music anywhere there is a WiFi signal.

Q: Can it play high resolution music?

A: Yes. Our devices can play APE and FLAC within the normal bit rate range. They also support decoding 24bit/192kHz music files.

Q: How many languages do you support?

A: Our devices will auto-detect your mobile device language and change automatically. Currently, we support English, French, German, Spanish, Chinese, Portuguese, Korean and Japanese and more on the way.

Q: What online music services do you support?

A: Spotify, Deezer, Tidal, Qobuz, Amazon Music, Napster, TuneIn radio, internet radio, iHeartRadio.

Q: Can I play local music?

A: Yes. You can play music from "MY MUSIC" on the application from local storage devices such as mobile device storage, USB thumb drives and NAS.

Q: Can the device work with Windows devices?

A: The Windows application is not available at the moment, but on the Windows PC, users can use iTunes, Foobar2000 and Spotify connect.

Q: Can all music sources play in multiroom mode?

A: Yes, the online music services, digital and analog input all can stream in multiroom mode.



@Copyright 2022 by RAKOSO. All Rights Reserved.

The information contained in this guide is believed to be accurate and reliable. RAKOSO assumes no responsibility for any errors contained in this guide. RAKOSO reserves the rights to make changes in the specifications and/or design of the above mentioned product without prior notice. The diagrams contained in this guide may also not fully represent the product that you are using and they are for illustration purposes. RAKOSO assumes no responsibility for any differences between the product mentioned in this guide and the product you may have.

Newest update can be found here: <https://forum.arylic.com/c/news/firmware-update-log/22>

Up-to-date user manual can be found here: <https://www.arylic.com/pages/download>