

# Keystage

## POLY AT MIDI KEYBOARD

# Owner's Manual

Setup

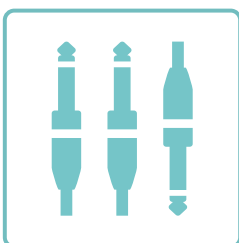

Basic operations

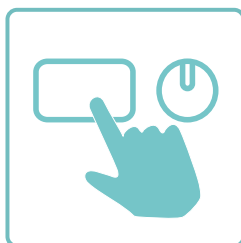

Controlling a sound generator

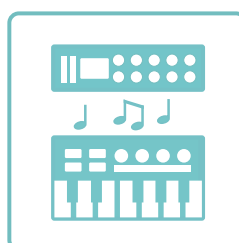

Using a DAW

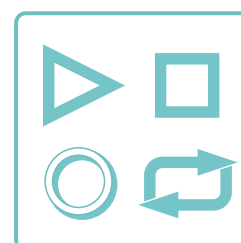

Using the arpeggiator

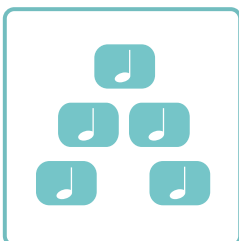

Playing in chord mode



Managing data and operations



Troubleshooting



\*Before using the Keystage, please read the Precautions (PDF) carefully to ensure proper use.

### Supplementary contents

**PDF** [Precautions, Quick Start Guide, Owner's Manual](#)

**MOVIE** [Keystage video manual](#)

**HELP** [How can we help? \(USB, DAW, MIDI 2.0\)](#)

**HELP** [How to use Keystage with DAWs](#)

**HELP** [How to use MIDI2.0 Property Exchange with Keystage](#)

**Prod.** [Product website](#)

# Table of Contents

---

<b>Owner's Manual .....</b>	<b>1</b>
<b>Introduction .....</b>	<b>5</b>
<b>Conventions in this manual .....</b>	<b>6</b>
<b>Main features .....</b>	<b>7</b>
<b>Part Names .....</b>	<b>8</b>
<b>Front panel .....</b>	<b>9</b>
<b>Rear panel .....</b>	<b>10</b>
<b>Connecting and getting ready to play .....</b>	<b>11</b>
<b>Connecting an external device .....</b>	<b>12</b>
Audio equipment.....	12
Pedals .....	12
Computer, iPad/iPhone .....	13
<b>Using the Keystage with your computer .....</b>	<b>14</b>
Application setup.....	14
<b>Using the Keystage with an iPad/iPhone.....</b>	<b>15</b>
<b>Using the Keystage with an external MIDI tone generator .....</b>	<b>16</b>
<b>Expansion plate .....</b>	<b>17</b>
Mounting the expansion plate.....	17
<b>Turning the power on and off.....</b>	<b>18</b>
Auto power-off function.....	18
<b>Basic operations.....</b>	<b>19</b>
<b>Basic audio and keyboard-related operations .....</b>	<b>20</b>
Adjusting the audio output .....	20
Keyboard .....	20
<b>Basic audio and keyboard-related operations .....</b>	<b>20</b>
Adjusting the audio output .....	20
Keyboard .....	20
Wheels.....	21
<b>Viewing and setting the parameters.....</b>	<b>22</b>
Main display .....	22
Sub display, knobs 1-8 .....	23

Switching between pages .....	23
<b>Changing the tempo .....</b>	<b>24</b>
Specifying a numeric value.....	24
Using tap tempo to change the tempo.....	24
<b>Other Operations .....</b>	<b>25</b>
VALUE button, VALUE dial.....	25
SHIFT button .....	25
WRITE button .....	26
<b>Controlling a sound generator .....</b>	<b>27</b>
<b>Selecting and playing sounds .....</b>	<b>28</b>
<b>Operating the sound parameters .....</b>	<b>29</b>
<b>Assigning control change messages to the knobs and other controls (user page) .....</b>	<b>30</b>
Assigning to a user page.....	30
Recalling the user page .....	32
Resetting the user page.....	32
<b>Using a DAW .....</b>	<b>33</b>
<b>Operating the transport .....</b>	<b>34</b>
<b>Other DAW operations.....</b>	<b>35</b>
<b>Using the arpeggiator .....</b>	<b>36</b>
<b>Playing arpeggios .....</b>	<b>37</b>
<b>Adding variation to the arpeggio.....</b>	<b>38</b>
Page 1 (General) .....	38
Page 2 (Rhythm).....	40
Page 3 (Dynamics) .....	41
<b>Arpeggio rhythm pattern list.....</b>	<b>43</b>
<b>Assigning arpeggiator settings to the knobs (user page).....</b>	<b>44</b>
Assigning parameters to a user page .....	44
Recalling the user page.....	45
Resetting the user page.....	45

<b>Playing chords by pressing a single key (chord mode)</b> .....	<b>47</b>
<b>Playing chords</b> .....	<b>48</b>
<b>Changing chord sets and how the chords play</b> .....	<b>49</b>
<b>Registering the chords you like (user chords)</b> .....	<b>51</b>
<b>Managing data and operations</b> .....	<b>52</b>
<b>Configuring the overall operations of the Keystage</b> .....	<b>53</b>
Overall settings (MIDI, auto power-off, etc.).....	53
Keyboard-related settings (velocity curve, etc.) .....	54
Pedal-related settings .....	55
<b>Switching between scenes</b> .....	<b>57</b>
Saving a Scene .....	57
Recalling a scene .....	58
<b>Using KORG KONTROL Editor</b> .....	<b>59</b>
Keyboard (keyboard settings) .....	59
Wheel (modulation wheel settings).....	59
Encoder (DAW play position settings).....	59
Knob (settings for knobs 1-8) .....	59
Button (settings for other DAW operations).....	60
Property Exchange (MIDI 2.0 Property Exchange settings) .....	60
<b>Adjusting the pedals</b> .....	<b>61</b>
<b>Restoring the Keystage to factory-set default settings</b> .....	<b>63</b>
<b>Appendices</b> .....	<b>64</b>
<b>Troubleshooting</b> .....	<b>65</b>
The instrument does not turn on .....	65
No audio is output .....	65
The software doesn't respond. ....	65
The buttons or controllers aren't working correctly.....	65
<b>Preset chord sets (chord mode)</b> .....	<b>66</b>
<b>Specifications</b> .....	<b>71</b>
<b>Operating requirements (for USB connection)</b> .....	<b>73</b>
<b>MIDI Implementation Chart</b> .....	<b>74</b>

# Introduction

---

Thank you for purchasing the KORG Keystage 49/61 POLY AT MIDI keyboard.

To take full advantage of this instrument's functionality and ensure years of trouble-free operation, please read this Owner's Manual carefully before use.

→ [Conventions in this manual](#)

→ [Main features](#)

## Conventions in this manual

---

- The shape and displays shown by illustrations in this manual may differ in some ways from the actual product.
- The parameter values shown in the example screens of this manual are only for explanatory purposes, and may not necessarily match the values that appear in the display of your instrument.
- Symbols used in this manual



This indicates an explanation that you should heed to ensure that you can correctly utilize the performance or functionality of this unit.

*Note* This indicates an explanation that requires your attention.

*Tip* This indicates supplementary information that is useful to know.

“ ” Parameters shown in the display are indicated in quotation marks.

## Main features

---

- The keyboard features polyphonic aftertouch, allowing for a wide degree of expressiveness.
- The arpeggiator function lets you play a variety of patterns. The ratchet function lets you change how the arpeggiator works in real time.
- The chord function (chord mode) lets you play one chord after another by using just one finger. There are 32 preset chord sets, as well as 32 user chord sets to which you can register data as you like.
- The instrument features eight knobs with sub displays. The parameter names and values are shown under each knob for editing the settings in an intuitive way.
- The instrument can connect with and operate various DAW applications, without the need to make special settings.
- This instrument supports some MIDI 2.0 functions (Property Exchange), and can interact with compatible sound generators.
- This instrument features audio interface functionality, letting you output the sound from your DAW software or software-based sound generator just by connecting this instrument to your computer or iPad/iPhone.
- You can mount the expansion plate onto this instrument to hold your mobile devices, computer and other items.

## Part Names

---

→ [Front panel](#)

→ [Rear panel](#)



# Front panel

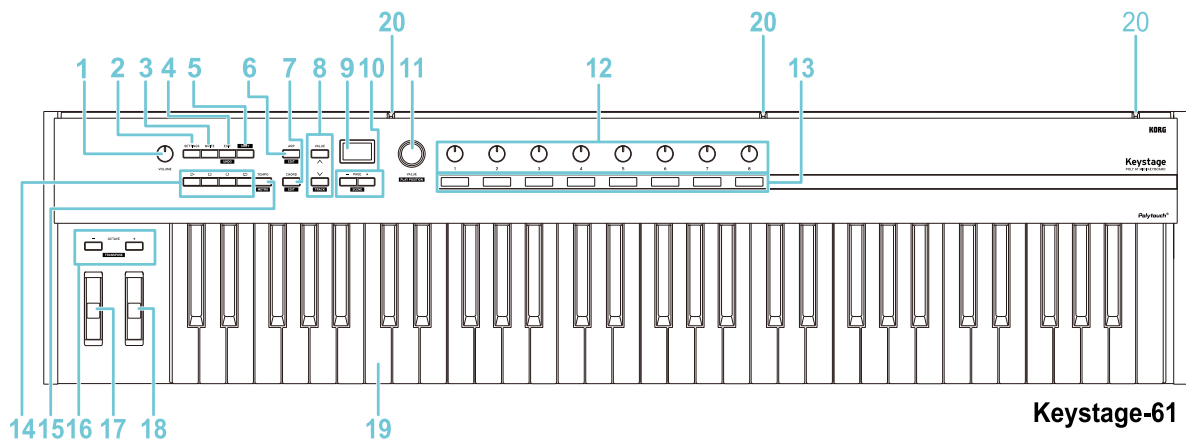
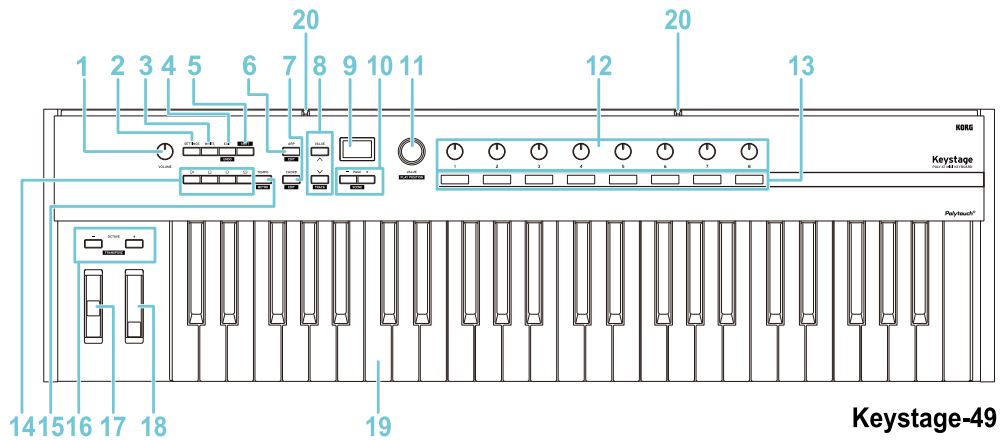

- 1** VOLUME knob → [Adjusting the audio output](#)
- 2** SETTINGS button → [Configuring the overall operations of the Keystage](#)
- 3** WRITE button → [WRITE button](#)
- 4** EXIT button → [Main display](#)
- 5** SHIFT button → [SHIFT button](#)
- 6** ARP button → [SHIFT button, Playing arpeggios](#)
- 7** CHORD button → [SHIFT button, Playing chords](#)
- 8** VALUE button → [VALUE button, VALUE dial](#)
- 9** Main display → [Main display](#)
- 10** PAGE -, + buttons → [Switching between pages](#)
- 11** VALUE dial → [VALUE button, VALUE dial](#)
- 12** Knobs 1-8 → [Sub display, knobs 1-8](#)
- 13** Sub display → [Sub display, knobs 1-8](#)
- 14** Transport buttons → [Operating the transport](#)
- 15** TEMPO button → [Changing the tempo](#)
- 16** OCTAVE -, + buttons → [Switching octaves, transposing](#)
- 17** Pitch bend wheel → [Wheels](#)
- 18** Modulation wheel → [Wheels](#)
- 19** Keyboard → [Keyboard](#)
- 20** Expansion plate mounting hole → [Expansion plate](#)

## Rear panel

---

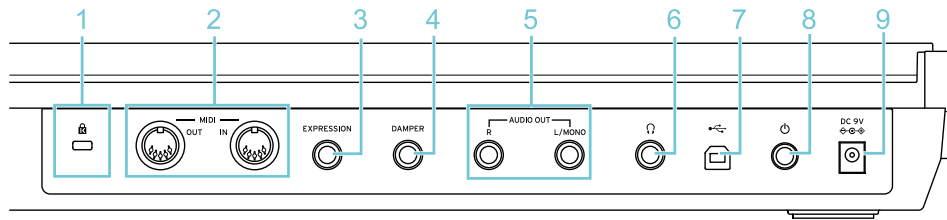

- 1** Anti-theft lock ( )
- 2** MIDI IN/OUT connectors → [Using the Keystage with an external MIDI tone generator](#)
- 3** EXPRESSION jack → [Connecting an external device](#)
- 4** DAMPER jack → [Connecting an external device](#)
- 5** AUDIO OUT (L/MONO, R) → [Connecting an external device](#)
- 6** Headphones jack → [Connecting an external device](#)
- 7** USB B port → [Using the Keystage with your computer](#)
- 8** Power button → [Turning the power on and off](#)
- 9** DC 9V jack → [Turning the power on and off](#)

*Tip:* Connect a commercially available security wire to the anti-theft lock.  
<http://www.kensington.com/>

## Connecting and getting ready to play

---



The Keystage does not have a built-in sound generator, so you can't use it on its own to make music. To play sound with the Keystage, you must first install an application such as a software sound generator on your computer or iPad/iPhone.

- [Connecting an external device](#)
- [Using the Keystage with your computer](#)
- [Using the Keystage with an iPad/iPhone](#)
- [Using the Keystage with an external MIDI tone generator](#)
- [Expansion plate](#)
- [Turning the power on and off](#)

## Connecting an external device

- ⚠** Before connecting external devices to this instrument, make sure that all devices are turned off. If you connect these devices while they are still on, this may cause your powered monitor speakers or other external devices to malfunction, or cause damage.

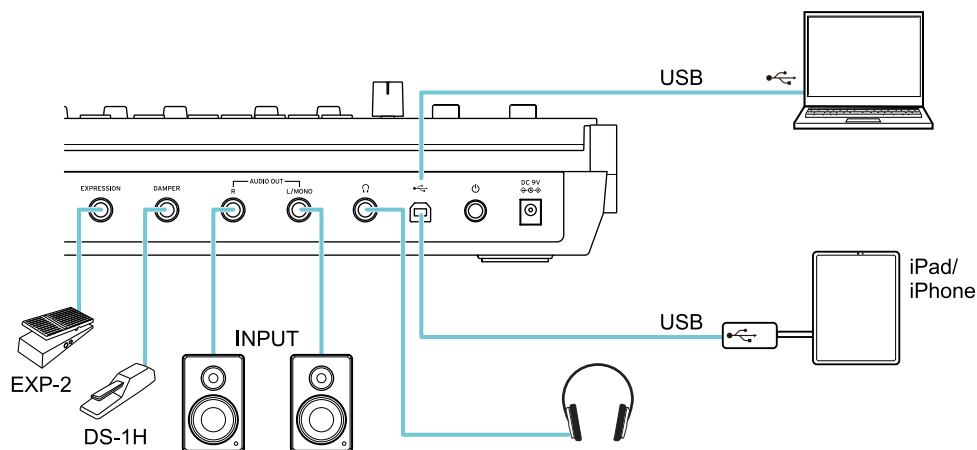

### Audio equipment

#### AUDIO OUT L/MONO, R jacks (6.3 mm TS phone jack)

Connect these jacks to a powered monitor speaker or similar equipment. Use the VOLUME knob to adjust the volume.

#### Headphones jack (6.3 mm stereo phone jack)

Connect your headphones here. The headphones jack outputs the same signal as the AUDIO OUT L/MONO and R jacks.

### Pedals

- ⚠** This instrument automatically detects the polarity of the pedals when you turn it on. Be sure not to press the pedals when turning on the power, to prevent the instrument from accidentally detecting the wrong polarity. When you connect a different pedal, turn off this instrument and then turn it on again.

#### DAMPER phone jack (6.3 mm phone jack, half-damper supported)

Connect a Korg DS-1H damper pedal or a PS-1/PS-3 pedal switch (sold separately) to control the damper function. When the DS-1H is connected, it functions as a half-damper pedal.

You can also use the damper pedal and pedal switch to switch between sounds.

#### EXPRESSION jack (6.3 mm phone jack)

A Korg EXP-2 (foot controller) or XVP-20 (expression pedal, sold separately) can be connected to this jack. Use this to send specific MIDI messages for applying modulation to the sound or for adjusting the volume.

*Tip:* You can calibrate the pedal so that it works more accurately.

→ [Adjusting the pedals](#)

*Tip:* You can configure the functions that are controlled by the DAMPER jack and the EXPRESSION jack from the settings screen.

→ [Pedal-related settings](#)

## | **Computer, iPad/iPhone**

### **USB B port**

By connecting to a computer, iPhone, or iPad via USB, you can use the Keystage as an audio output or MIDI controller for applications such as DAWs and software sound generators.

→ [Using the Keystage with your computer](#)

→ [Using the Keystage with an iPad/iPhone](#)

## Using the Keystage with your computer

---

Here's how to connect the Keystage to your computer, and control a DAW or software sound generator on your computer from this instrument to output sound.

For Windows PCs: before connecting the USB cable, download the USB-MIDI and audio drivers from the Korg website, and install them on your computer.

[https://www.korg.com/keystage\\_driver/](https://www.korg.com/keystage_driver/)

- KORG USB-MIDI Driver
- Keystage Audio Driver

For Macs: you do not need to install a driver. (This information is current as of March 2023, for macOS 11 and 12. For details, refer to the Korg website.)



Turn the VOLUME knob of the Keystage all the way down before turning on the power.

Check whether your computer meets the operating requirements of the Keystage before use.

See the Korg website for the latest information on OS support.

<https://www.korg.com/support/os/>

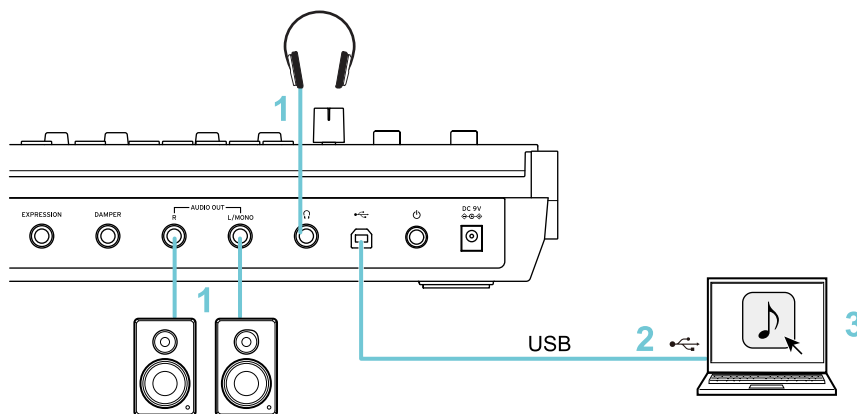

- 1 Connect the Keystage to an external device such as a powered monitor speaker or headphones.  
→ [Connecting an external device](#)
- 2 Connect the USB-B port on the Keystage to your computer with a USB cable.  
The Keystage automatically turns on, as it is supplied by USB bus power.
- 3 On your computer, launch an application such as a DAW or software sound generator.
- 4 Use the VOLUME knob on the Keystage to adjust the volume.

### | Application setup

To use this instrument with your computer, you must configure the audio output, MIDI input/output and other settings in the application you are using. Refer to the application's owner's manual for details.

## Using the Keystage with an iPad/iPhone

Here's how to connect the Keystage to your iPad/iPhone, and control a DAW or software sound generator running on that device from this instrument to output sound.

A USB-C to USB adapter or a Lightning to USB camera adapter is required to connect the Keystage to an iPad or iPhone.

- ⚠ Make sure to use the included USB cable.
- ⚠ When connecting to an iPad/iPhone equipped with a Lightning connector, you must connect an AC adapter (sold separately) to the DC 9V jack of the Keystage.
- ⚠ Turn the VOLUME knob of the Keystage all the way down before turning on the power. Check whether your iPad/iPhone meets the operating requirements of the Keystage before use.

See the Korg website for the latest information on OS support.

<https://www.korg.com/support/os/>

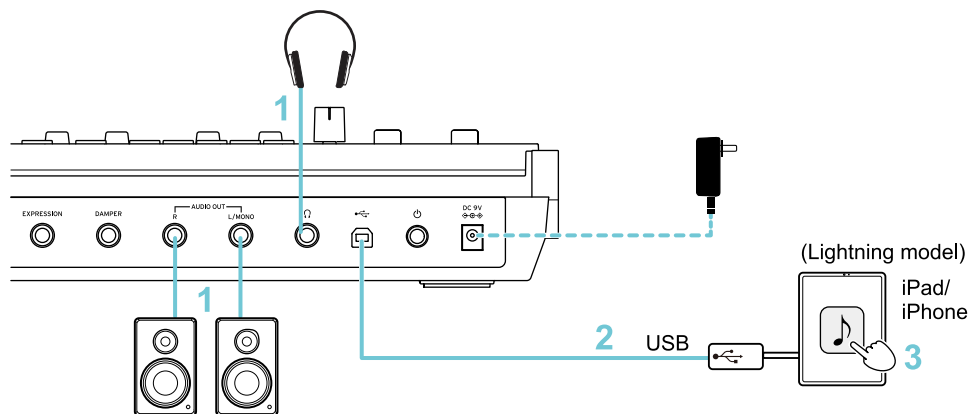

- 1 Connect the Keystage to an external device such as a powered monitor speaker or headphones.  
→ [Connecting an external device](#)
- 2 Use a USB cable to connect the USB-B port on the Keystage to the USB adapter that's connected to your iPad/iPhone.  
**iPads/iPhones with a USB-C port:**  
Use a USB-C to USB adapter. The Keystage automatically turns on when connected, as it is supplied by USB bus power.  
**iPads/iPhones with a Lightning connector:**  
Use a Lightning to USB camera adapter. Connect an AC adapter (sold separately) to the Keystage and press the power button on the Keystage to turn on the power.
- 3 On your iPad/iPhone, launch an application such as a DAW or software sound generator.
- 4 Use the VOLUME knob on the Keystage to adjust the volume.

## Using the Keystage with an external MIDI tone generator

You can play an external MIDI tone generator with the Keystage's keyboard or by using the control arpeggiator, and you can control its parameters. See the owner's manual of the external MIDI device for how to connect and configure it.

MIDI stands for Musical Instrument Digital Interface, and is a worldwide standard for exchanging various types of musical data between electronic musical instruments and computers.

When MIDI cables are used to connect two or more MIDI devices, performance data can be exchanged between the devices, even if they were made by different manufacturers.

*Tip:* The performance data of the Keystage is output from the global MIDI channel. You can change the global MIDI channel.

→ [Configuring the overall operations of the Keystage](#)

*Tip:* You can also use the KORG Kontrol Editor to configure the MIDI channels that are used by the keyboard, knobs, modulation wheel and other controllers. For details, visit the Korg website ([www.korg.com](http://www.korg.com)).

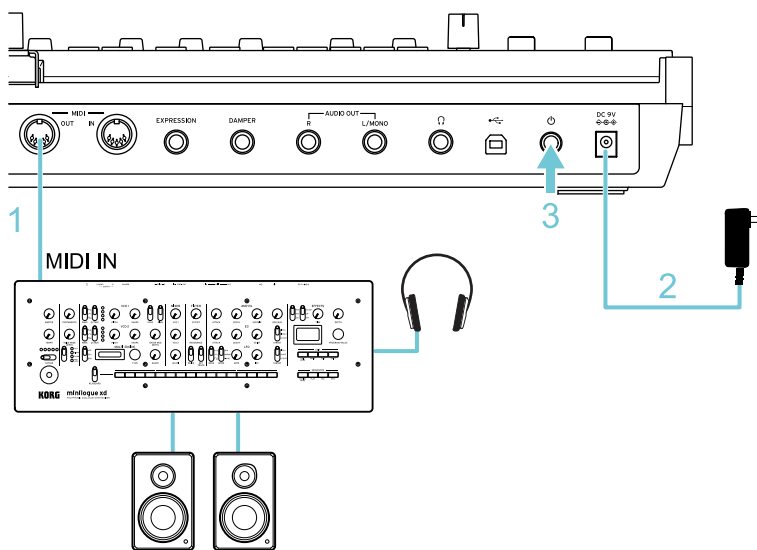

- 1 Connect the Keystage's MIDI OUT connector to your external MIDI tone generator's MIDI IN connector.
- 2 Connect the AC adapter (sold separately) to the DC 9V jack.  
You can also connect a commercially available USB 2.0 standards-compliant AC adapter (at least 5 V DC 550 mA) to the USB-B port on this instrument.
- 3 Press the power button to turn on the Keystage.

*Note:* You can use an AC adapter (sold separately) to power this instrument, or use a commercially available USB 2.0 standards-compliant AC adapter (at least 5 V DC 550 mA).

**⚠** Note that some standards-compliant USB AC adapters might not operate correctly.



## Expansion plate

---

You can mount the expansion plate onto the Keystage to hold your mobile devices and other items. The expansion plate can be attached horizontally or at an angle.

- Keystage-61: Can be mounted on the center or on the right side
- Keystage-49: Can be mounted on the center

**Examples: setting up the expansion plate at an angle or horizontally**

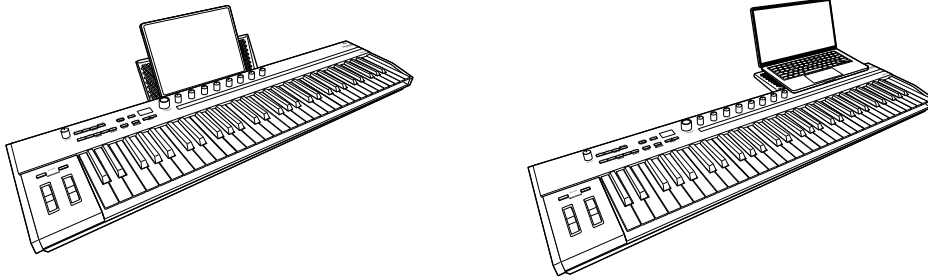

**⚠** Do not place any devices onto the expansion plate that stick out considerably past the sides. This may cause the device to fall off.

*Tip:* For the Keystage-61, you can place a small laptop computer on the expansion plate, but only when the plate is mounted horizontally and on the right-hand side.

## | Mounting the expansion plate

Insert the pegs of the expansion plate firmly into the mounting holes on this instrument. Make sure that the pegs go in all the way. When you install the expansion plate so that the plate is angled upwards, this is the angled position. When the expansion plate is angled downwards, this is the horizontal position.

**Mounting the expansion plate at an angle or horizontally**

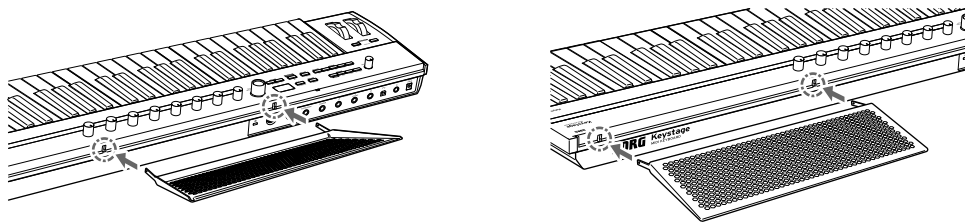

## Turning the power on and off

---

Press the power button to turn the power on, and long-press the power button to turn the power off.

When operating the Keystage on USB bus power, the power automatically turns on when a USB cable is connected.

*Note:* Wait at least five seconds when switching the power on and off again.

When USB bus power can't be used, or when you are using the Keystage to control an external MIDI tone generator, connect an AC adapter (sold separately) to the DC 9V jack on the Keystage. You can also connect a commercially available USB 2.0 standards-compliant AC adapter (at least 5 V DC 550 mA) to the USB-B port.

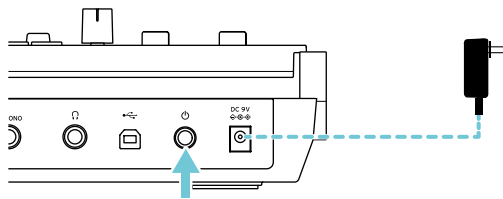

### | Auto power-off function

The Keystage automatically turns off when four hours have elapsed since the front panel or keyboard was operated, or since MIDI was received or transmitted. You can change the amount of time it takes for the Keystage to turn off automatically, or disable the auto power-off feature entirely.

→ [Configuring the overall operations of the Keystage](#)

## Basic operations

---

- [Basic audio and keyboard-related operations](#)
- [Viewing and setting the parameters](#)
- [Changing the tempo](#)
- [Other Operations](#)

# Basic audio and keyboard-related operations

---

## | Adjusting the audio output



VOLUME

Turn the VOLUME knob to adjust the volume that's output from the AUDIO OUT L/MONO and R jacks, and from the headphone jack.

## | Keyboard

The keyboard on the Keystage supports note on/off and velocity, and you can control aftertouch and MPE (MIDI Polyphonic Expression) according to how hard you push into the keys.

Performance and control data is output from the global MIDI channel (the base MIDI channel used for transmitting and receiving data).

Controlling the sound via how hard you push into the keys is set to polyphonic aftertouch by default.

You can change the global MIDI channel and aftertouch settings from the settings screen.

→ [Configuring the overall operations of the Keystage](#)

*Tip:* You can also use the KORG Kontrol Editor to configure the MIDI channels that are used by the keyboard, knobs, modulation wheel and other controllers. For details, visit the Korg website ([www.korg.com](http://www.korg.com)).

### Aftertouch

With aftertouch, you can make the sound change by pushing into the keys after you've pressed them.

- Channel aftertouch (channel pressure)  
This applies aftertouch on a per-channel basis. The overall sound changes regardless of which keys you play.
- Polyphonic aftertouch (polyphonic key pressure)  
This applies aftertouch on a per-key basis. You can make the effect change according to how hard you press into each key, or apply aftertouch to only one of the notes in a chord.

**⚠** The aftertouch sensors on the keyboard may wear out if you press into the keyboard too hard. For this reason, avoid pressing into the keyboard harder than necessary.

### MPE (MIDI Polyphonic Expression)

The Keystage supports MPE pressure (pressing into the keys). When you use MPE, each of the keys that you play on the Keystage is split into its own MIDI channel, and you can apply pressure control separately to each of their sounds. A sound generator that supports MPE is required to use this feature.

## Switching octaves, transposing



- 1 Use the OCTAVE -/+ keys to change the tonal range of the keyboard in one-octave steps, up or down.  
The setting appears in the main display when you operate this control.  
The buttons light up or blink to indicate their setting.

Octave	Button	Status
+3	OCTAVE +	Blinks quickly
+2		Blinks slowly
+1		Button lights
Normal	OCTAVE -, +	Button goes dark
-1	OCTAVE -	Button lights
-2		Blinks slowly
-3		Blinks quickly

- 2 Press the OCTAVE -/+ buttons while holding down the SHIFT button to transpose the keyboard (in semitone steps, up or down).
- 3 Press the OCTAVE - and + buttons together to return to the standard pitch.

## | Wheels

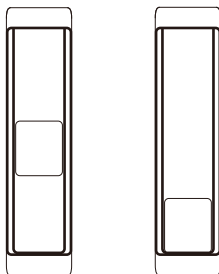

### Pitch bend wheel (left)

Move this wheel forward or backward to control the pitch. The center is the normal position, where there is no pitch change. The wheel moves back to center position when you release it.

### Modulation wheel (right)

Move the modulation wheel forward for a deeper modulation effect. The modulation wheel stays in its position when you release it, and the effect continues.

You can edit the MIDI messages that are controlled by the modulation wheel from the user page.

→ [Assigning control change messages to the knobs and other controls \(user page\)](#)

# Viewing and setting the parameters

---

## | Main display

### Main screen

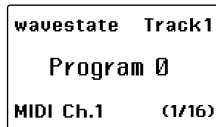

This screen is normally shown.

To see this screen, press the EXIT button.

The name of the currently selected scene, program number and so on are shown on the main screen.

**Top left:** scene name

**Top right:** DAW track name (only when using a DAW that supports the display of track names)

**Center:** program number

**Bottom left:** global MIDI channel

**Bottom right:** sub display page number

### Edit screen (arpeggiator)

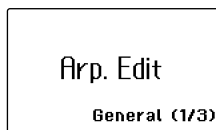

This screen is shown when you change the arpeggiator settings.

To see this screen, from the main screen press the ARP button while holding down the SHIFT button.

### Edit screen (chord mode)

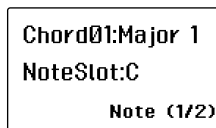

This screen is shown when you change the chord mode settings.

To see this screen, from the main screen press the CHORD button while holding down the SHIFT button.

### Settings screen

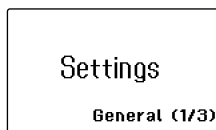

This screen is used for configuring the operations of the Keystage.

To see this screen, from the main screen press the SETTING button.

*Tip:* The Keystage's display automatically goes dark if the front panel or keyboard have not been operated for a while, or if MIDI messages have not been received or transmitted (default setting: 1 hour). You can change the time elapsed before the display goes dark, and you can make the display always stay lit.

→ [Configuring the overall operations of the Keystage](#)

## | Sub display, knobs 1-8

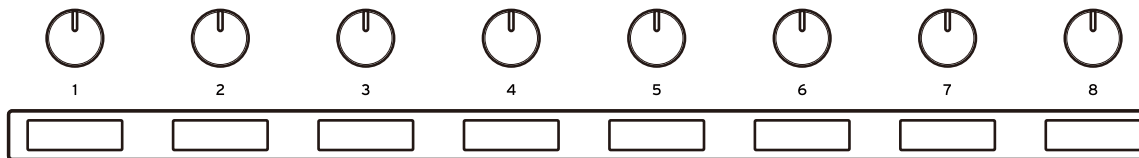

The sub display shows the parameters that you can change with knobs 1-8, along with their values.

The items that you can change with knobs 1-8 differ depending on the screen shown in the main display.

**While main screen is shown:** controls the sound generator parameters

**While the edit screen (arpeggiator) is shown:** controls the arpeggiator parameters

**While the edit screen (chord mode) is shown:** controls the chord mode parameters

**While the settings screen is shown:** changes various settings for this instrument

## | Switching between pages

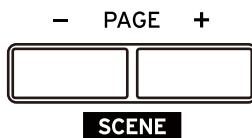

For screens that have many parameters, the parameters are divided into groups (pages). When you use the PAGE -, + buttons to switch between pages, the parameters that you can control with knobs 1-8 change.

The page currently shown is indicated at the bottom right corner of the main display.

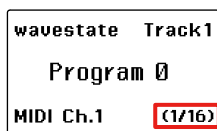

While the main screen is shown, press the PAGE -/+ buttons while holding down the SHIFT button to switch scenes.

→ [Recalling a scene](#)

## Changing the tempo

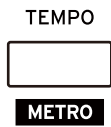

Press the TEMPO button to show the tempo value in the main display. The Keystage's arpeggiator plays at the tempo you set here. After you make the setting, the screen returns to the previous view.

If you're using a DAW with this instrument, press this button while holding down the SHIFT button to turn the DAW's metronome on/off.

### | Specifying a numeric value

- 1 Press the TEMPO button to show the tempo setting screen.

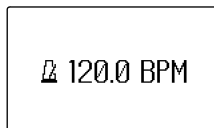

- 2 Use the VALUE dial or VALUE buttons to change the tempo.

*Tip:* Turn the VALUE dial slowly to change the tempo in 0.1 BPM increments, and turn it quickly to change the tempo in 10 BPM increments.

### | Using tap tempo to change the tempo

Tap tempo is a function that lets you set the tempo by repeatedly pressing the button. This is useful when you want to set the tempo based on the rhythmic pulse, rather than by inputting a number.

- 1 Press the TEMPO button two or more times at the tempo that you want to set. Repeatedly pressing the button sets the tempo at the average interval between button presses. This lets you set the tempo more accurately.

*Note:* The tempo is synchronized to any MIDI clocks received via the MIDI IN connector or the USB port. In this case, the Keystage tempo is displayed as "External". The Keystage operates with its internal tempo when MIDI clocks are not being received. To synchronize this instrument with a DAW or similar software, you must configure the MIDI clock settings in that software.



## Other Operations

### VALUE button, VALUE dial

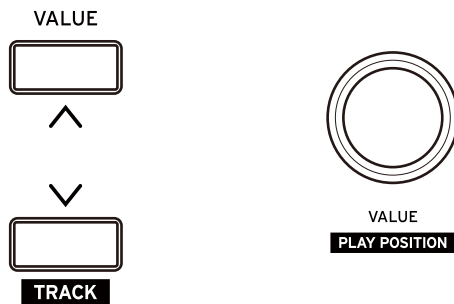

- **While main screen is shown:** changes the sound played by the sound generator (program change).
- **While the tempo is shown:** edits the tempo value.
- **While editing:** changes the values shown in the main display.
- **While inputting characters:** changes the character type.

When using a DAW, if you operate these controls while holding down the SHIFT button, you can switch between DAW tracks and move the playback location.

### SHIFT button



Use the SHIFT button together with another button or control to execute specific functions.

Button or dial to use in combination	Function
OCTAVE -, + buttons	Transposes the keyboard. → <a href="#">Basic audio and keyboard-related operations</a>
EXIT button	Controls the DAW (undo operations, metronome on/off, switching between tracks, moving the playback location). → <a href="#">Using a DAW</a>
TEMPO button	
VALUE button	
VALUE dial	
ARP button	Shows the arpeggiator edit screen. → <a href="#">Adding variation to the arpeggio</a>
CHORD button	Shows the chord mode edit screen. → <a href="#">Changing chord sets and how the chords play</a>
PAGE -, + buttons	Recalls a saved scene. → <a href="#">Recalling a scene</a>

## | WRITE button

WRITE

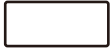

Press this button to register the scenes or settings you've edited and in similar situations.

## Controlling a sound generator

---

*Note:* To control a sound generator from the Keystage, the sound generator must be able to receive and process the MIDI messages sent from the controllers on this instrument. Also refer to the owner's manual of the sound generator for details.

→ [Selecting and playing sounds](#)

→ [Operating the sound parameters](#)

→ [Assigning control change messages to the knobs and other controls \(user page\)](#)

*Tip:* The Keystage supports the use of MIDI 2.0 Property Exchange (transmitting and receiving sound and parameter names between devices). For details, visit the Korg website.

<https://support.korguser.net/hc/>

## Selecting and playing sounds

You can use the Keystage to switch between sounds (sound programs and so forth) played by the sound generator.

*Note:* This only works with sound generators that support program change messages.

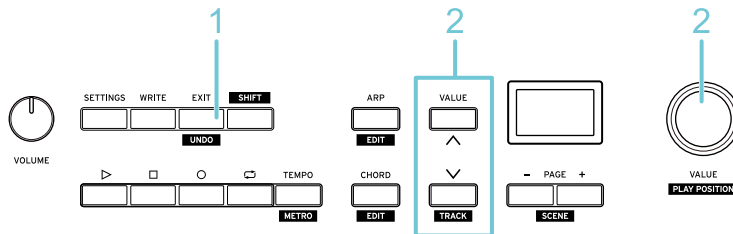

- 1 Press the EXIT button to access the main screen.
- 2 Use the VALUE button or VALUE dial to select a sound.  
The currently selected program number is shown on the main screen.

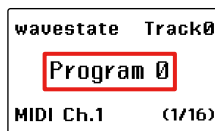

- 3 Play the keyboard.  
If the sound generator supports it, you can use the following controllers to modify the sound.
  - Keyboard (note-on/off, velocity, aftertouch)
  - Modulation wheel
  - Pitch bend
  - Pedal connected to the DAMPER jack
  - Pedal connected to the EXPRESSION jack

# Operating the sound parameters

Control change messages (CC#0 through CC#127) are pre-assigned to knobs 1-8 of the Keystage. You can operate the parameters of the sound generator while switching between the eight control change groups (pages).

Check the control change numbers beforehand that are assigned to the parameters of your sound generator.

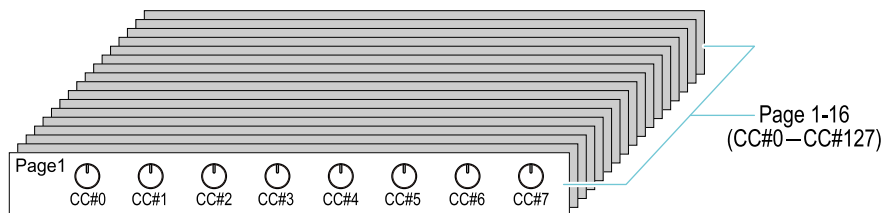

*Tip:* If you're using a sound generator that supports MIDI 2.0, the sound generator's parameters are automatically assigned to knobs 1-8. For details, visit the Korg website ([www.korg.com](http://www.korg.com)).

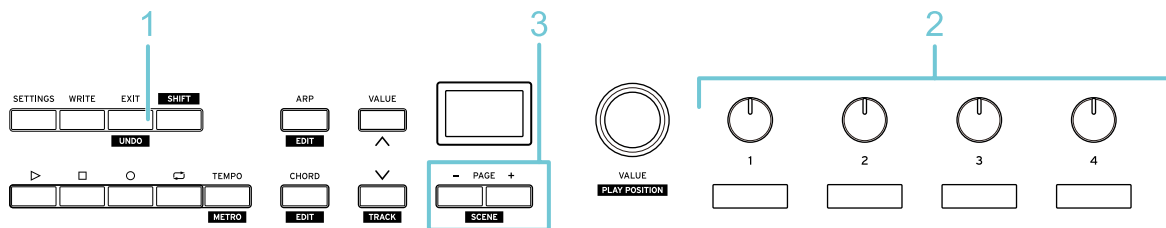

- 1 Press the EXIT button to access the main screen.
- 2 Turn knobs 1-8 to adjust the parameters of the sound generator. The control change numbers that correspond to the knobs are shown in the sub display.

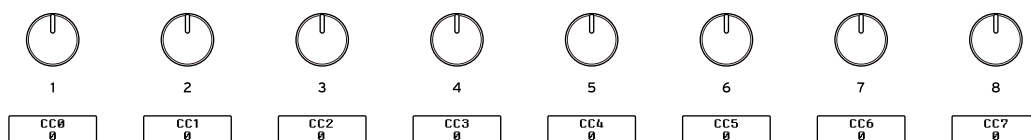

- 3 Press the PAGE – or + button to switch between pages. The number of the current page and the total number of pages are indicated on the main screen.

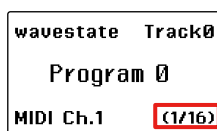

When you're switching between pages or when you switch to play a different sound generator, you may notice some discrepancies between the knob position and parameter value. If this happens, turn the knob to immediately reset the parameter's value to the knob's position.

*Tip:* To assign your favorite control change messages to other knobs, use the dedicated pages (user page) to register your custom settings.

→ [Assigning control change messages to the knobs and other controls \(user page\)](#)

# Assigning control change messages to the knobs and other controls (user page)

You can select the control change messages you desire that are assigned to the knobs, and register them on a dedicated page (the user page). Use this to customize the CC messages so that they're more appropriate for your sound generator.

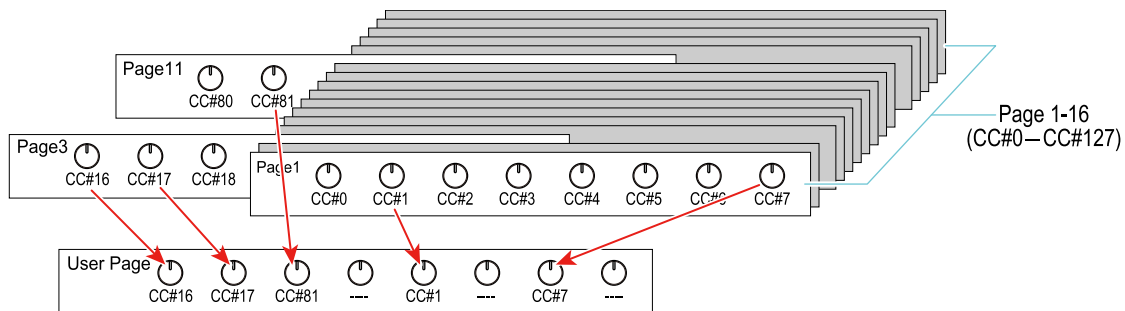

Scenes with preset user pages are available for the following software sound generators. Select the scene that matches the software sound generator you're using.

- wavestate native, opsix native, modwave native, microKORG, TRITON, Polysix

→ [Switching between scenes](#)

*Tip:* With the user page, you can also assign control change messages for the modulation wheel, key velocity and aftertouch.

*Tip:* You can use KORG Kontrol Editor as well to register the data. For details, visit the Korg website ([www.korg.com](http://www.korg.com)).

## Assigning to a user page

Here's an example of how to assign CC messages to the user page. This example shows how to assign CC#10 (knob 3) from edit page 2 to knob 1 of the user page.

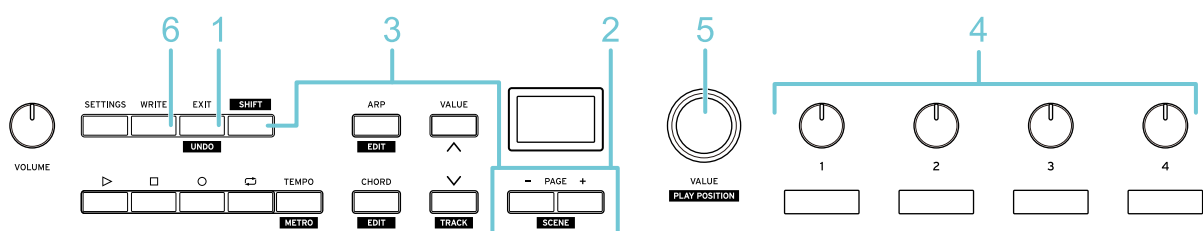

- 1 Press the EXIT button to access the main screen.
- 2 Press the PAGE – or + button to access the page containing the control change message you want to assign.

In this example, we go to page 2 where CC#10 is.

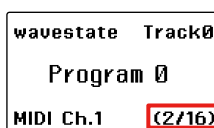

- 3 Press the WRITE button while holding down the SHIFT button.

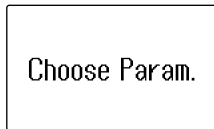

- 4 Turn the knob of the control change message you want to register to the user page. The sub display that corresponds to that knob blinks. Turn knob 3 to select “CC#10”.

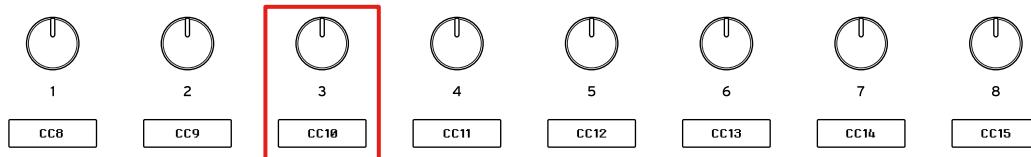

- 5 Turn the VALUE dial. On the main display, select the controller to which you want to register the CC message. In this example, select “UsrPg Knob1” (knob 1).

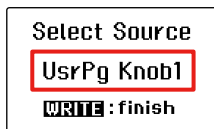

By selecting a knob from 1 to 8, the CC message is registered to the corresponding knob on the user page.

Indication	Controllers
UsrPg Knob1-UsrPg Knob8	Knobs 1-8
Modwheel	Modulation wheel
Velocity	Keyboard velocity
Aftertouch	Aftertouch
None	No assignment

- 6 To register, press the WRITE button. The display returns to the main screen.

**⚠** The user page settings are included in the scene data. Any settings that you've edited are lost if you turn off the power or select another scene without saving it.

→ [Switching between scenes](#)

**⚠** When connected via MIDI 2.0 Property Exchange, the settings cannot be registered to a user page, as the CC numbers are automatically assigned.

## Recalling the user page

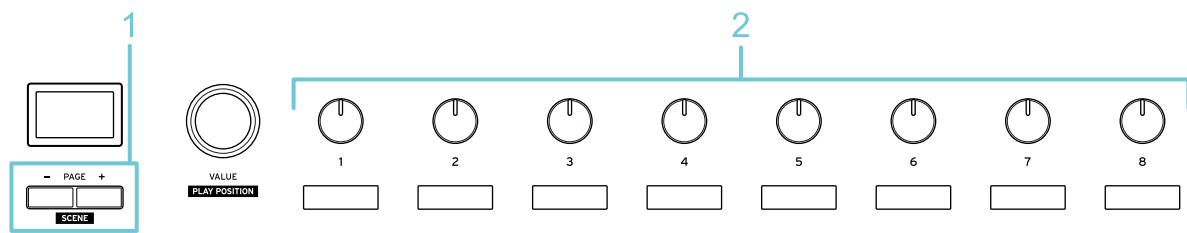

- 1 On the main screen, press the PAGE +/- buttons to select "User Page".

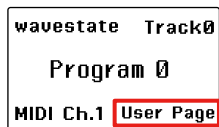

*Note:*The user page is only shown when it is registered.

- 2 Turn the knob to adjust the control change message that you've assigned.

## Resetting the user page

Here's how to reset all of the settings of the user page to their unregistered state.

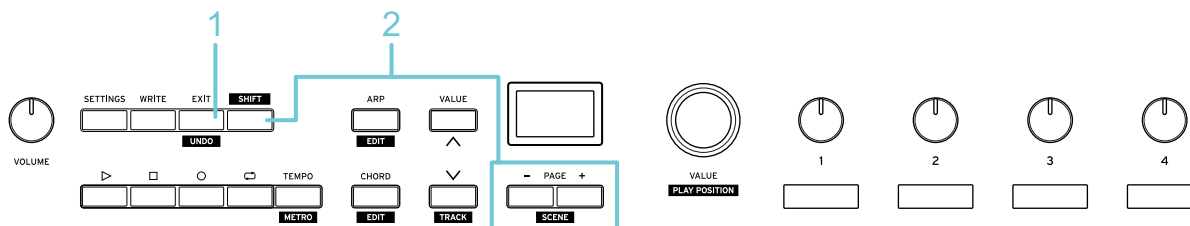

- 1 Press the EXIT button to access the main screen.
- 2 Hold down the WRITE button while holding down the SHIFT button. Once the user page is reset, the message "User Page Cleared!" is shown.

*Note:*This resets the user pages for the control change and for the arpeggiator.



## Using a DAW

---

Compatibility with the various DAW functions differs depending on the DAW that you use. For details, visit the Korg app Help Center.

→ [Operating the transport](#)

→ [Other DAW operations](#)

## Operating the transport

This shows how to use the Keystage to control the transport of your DAW.

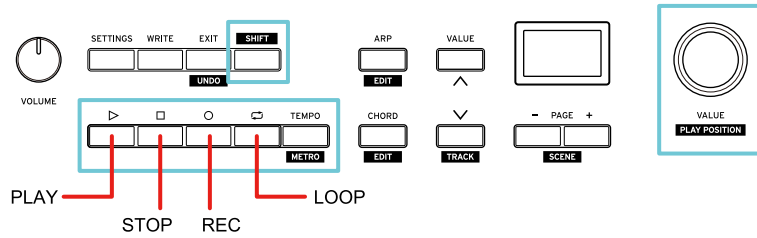

Function	Operation
Move the playback position	Turn the VALUE dial while holding down the SHIFT button
Playback	Press the PLAY button
Stop	Press the STOP button
Record	Press the REC button
Turn the metronome on/off	Press the TEMPO button while holding down the SHIFT button
Switching loop settings	Press the LOOP button

## Other DAW operations

---

This shows how to select tracks on your DAW and undo operations from the Keystage.

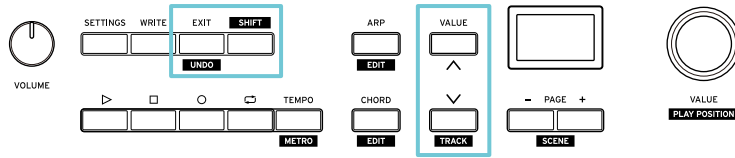

### Selecting a track

- 1 Press one of the VALUE buttons while holding down the SHIFT button. Each time you press the button, the DAW track changes.

### Undoing an operation

- 1 Press the EXIT button while holding down the SHIFT button. The operation you just executed is canceled, and the DAW goes back to the previous state.

## Using the arpeggiator

---

The arpeggiator is a function that automatically separates the notes of a played chord and plays them in sequence. The arpeggiator on the Keystage also contains a variety of rhythm patterns that let you perform in rhythm just by playing a chord.

- [Playing arpeggios](#)
- [Adding variation to the arpeggio](#)
- [Assigning arpeggiator settings to the knobs \(user page\)](#)

## Playing arpeggios

---

Here's how to play notes on a sound generator or other sound source by using the arpeggiator on the Keystage. To do this, first get your sound generator or similar device ready to play.

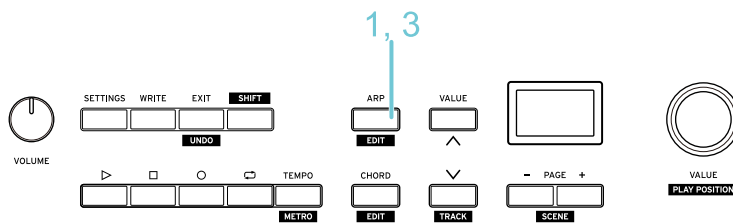

- 1** Press the ARP button to turn the arpeggiator on (the button lights up).
- 2** Play a chord on the keyboard.  
The arpeggio begins playing. See “Basic operations” for how to change the tempo.  
→ [Changing the tempo](#)  
*Tip:*The notes played by the arpeggiator are transmitted via the global MIDI channel.  
→ [Configuring the overall operations of the Keystage](#)
- 3** Press the ARP button once more to turn off the arpeggiator.

# Adding variation to the arpeggio

Now, let's change the arpeggiator settings to add variation to the arpeggio.

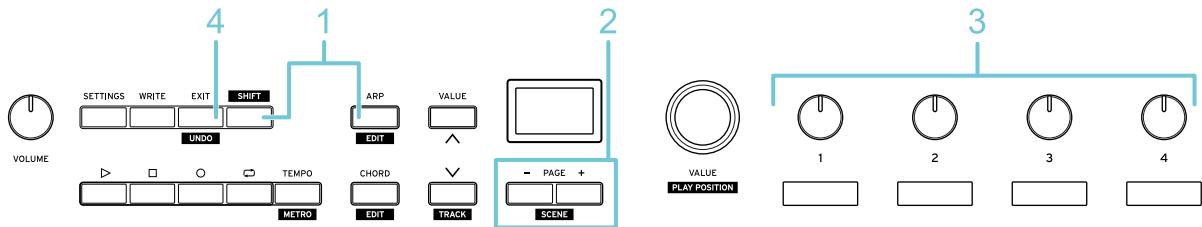

- 1 Press the ARP button (the button blinks) while holding down the SHIFT button. The arpeggiator edit screen (page 1) is shown.

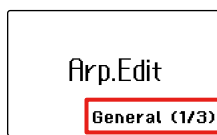

The arpeggiator edit screen consists of three pages.

- **Page 1 (General):** edits the basic settings for the arpeggio.
- **Page 2 (Rhythm):** edits the rhythm-related elements of the arpeggio.
- **Page 3 (Dynamics):** edits the volume, note length and other elements of the arpeggio.

- 2 Press the PAGE -/+ buttons to access the page containing the setting you want to edit.
- 3 Turn knobs 1-8 to edit the arpeggiator settings. Play the keyboard to check the results of your edits.

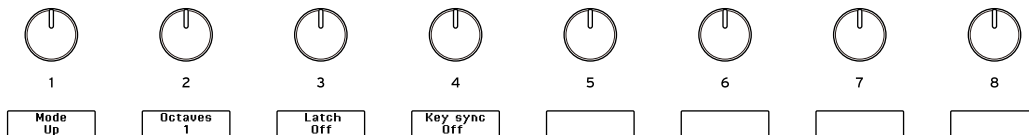

- 4 To finish editing, press the EXIT button. The display returns to the main screen.

*Tip:* You can register your custom settings in the user page if you want to use the knobs for editing the arpeggiator settings.

→ [Assigning arpeggiator settings to the knobs \(user page\)](#)

## | Page 1 (General)

### Knob 1 [Mode]

This sets the note pattern (ascending, descending, etc.) of the arpeggiator.

**Up:** The arpeggio is played from the lower note to the higher note.



**Down:** The arpeggio is played from the higher note to the lower note.

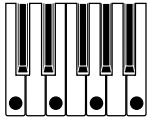

**Up-down:** The arpeggio repeatedly plays the arpeggio up and then down. The highest note and the lowest note of the arpeggio are only played once each time.

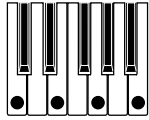

**Down-up:** The arpeggio repeatedly plays the arpeggio down and then up. The highest note and the lowest note of the arpeggio are only played once each time.

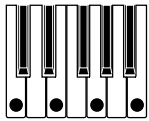

**Played:** The arpeggio plays in the order you play the keys.

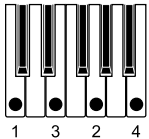

**Random:** Notes will be played randomly.

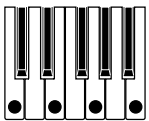

**Trigger:** The notes held down are played simultaneously. The “Octaves” setting is ignored.

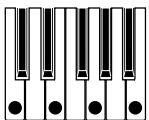

### **Knob 2 [Octaves]**

Specifies the range in octaves (1-4) over which the arpeggiator notes sound.

### **Knob 3 [Latch]**

Specifies how the arpeggiator operates when you take your hand off the keyboard.

**Off:** The arpeggiator stops when you take your hand off the keyboard. If you take your hands off the keyboard while pressing the damper pedal, the arpeggiator keeps playing as long as the damper pedal is pressed.

**On:** The arpeggiator keeps playing even after you take your hand off the keyboard.

### **Knob 4 [Keysync]**

Specifies how the arpeggiator operates when you play the keyboard.

**Off:** When you add another note to the chord, the existing arpeggio pattern keeps playing at the same position.

**On:** When you press a key, the arpeggiator resets and plays from the beginning of the arpeggio pattern.

## | Page 2 (Rhythm)

*Tip:* You can use knobs 4-7 to add special effects, like a ratchet effect that makes certain notes in the arpeggio play back in quick succession. Mix the different setting values to make a more complex arpeggio.

### Knob 1 [Rate]

Specifies the length of the arpeggiator notes.

**1/1-1/64:** The length can be set within the range of a whole note (1/1) to a sixty-fourth note (1/64). You can also set dotted note lengths (1/3, 1/6, 1/12, 1/24, 1/48).

### Knob 2 [Swing]

Shifts the timing of the even-numbered arpeggiated notes to add a shuffle effect.

**0%-100%:** Set this with a range of 0% (no effect) to 100% (maximum effect).

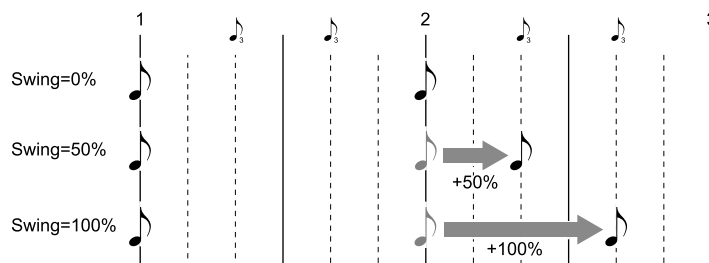

### Knob 3 [Pattern]

Selects a preset drum pattern on the Keystage.

→ [Arpeggio rhythm pattern list](#)

### Knob 4 [Ratchet Control]

Selects the source that will control the ratchet effect. If you've selected a controller such as aftertouch, velocity or the modulation wheel, the ratchet effect is applied when the controller value exceeds the "Ratchet Thre." (knob 5) setting.

**Off:** Turns the ratchet effect off (default value)

**Always:** Effect always applied

**AfterTouch:** Aftertouch

**ModWheel:** Modulation wheel

**Pedal 1:** Damper pedal

**Pedal 2:** Expression pedal

**Velocity:** Velocity value

**First Note:** Effect is applied to the first note of the arpeggio pattern

**Last Note:** Effect is applied to the last note of the arpeggio pattern

**Lowest Note:** Effect is applied to the lowest note of the arpeggio pattern

**Highest Note:** Effect is applied to the highest note of the arpeggio pattern

*Tip:* When "AfterTouch" is selected, the effect is controlled using the currently set aftertouch ("Channel" or "Polyphonic"). → [Configuring the overall operations of the Keystage](#)



### Knob 5 [Ratchet Thre.]

Sets the threshold value used for the ratchet effect. This only works when you've selected a controller such as aftertouch, velocity or the modulation wheel for "Ratchet Control" (knob 4).

**0-127:** The ratchet effect is applied if the value you set is exceeded (default setting: 64).

### Knob 6 [Ratchet Speed]

Specifies the speed of the notes repeatedly played in succession.

**1/1-1/128:** The same note is played repeatedly within the range of a whole note (1/1) to a 128th note (1/128).

### Knob 7 [Ratchet Cycle]

When the ratchet effect is applied, only the arpeggio for that part is played back faster, instead of repeating the same note. Use the "On" and "Off" setting to set whether this is enabled or disabled.

## | Page 3 (Dynamics)

### Knob 1 [Gate Time]

Specifies the length of each arpeggiator note.

**-100%-0%-+100%:** When this is set to a negative value, each note in the arpeggio is shorter. When this is set to a positive value, each note in the arpeggio is longer.

### Knob 2 [Gate Control]

Selects the control source for "Gate Time" (knob 1), and changes the length of each note in the arpeggio according to the controller's value.

**Off:** No control source

**AfterTouch:** aftertouch

**ModWheel:** modulation wheel

**Pedal 1:** pedal connected to the PEDAL 1 jack

**Pedal 2:** pedal connected to the PEDAL 2 jack

*Tip:* When "AfterTouch" is selected, the effect is controlled using the currently set aftertouch ("Channel" or "Polyphonic"). → [Configuring the overall operations of the Keystage](#)

### Knob 3 [Gate Depth]

Controls the depth of the "Gate Control" (knob 2) effect.

**-100%-0%-+100%:** When this is set to a negative value, larger controller values make each note shorter. When this is set to a positive value, larger controller values make each note longer.

### Knob 4 [Velocity]

Sets the arpeggio velocity value.

**Off:** The arpeggio plays according to the velocity of your keyboard playing.

**1-127:** The arpeggio notes always play at the velocity you set.

### Knob 5 [Chance]

Randomly removes notes from the arpeggio.

**1%-100%:** Sets the probability for removing notes. For example, when this is set to "50%", the arpeggio notes are removed half of the time.

# Arpeggio rhythm pattern list

No.	Name	Rhythm Pattern
1	ooxx	
2	ooox	
3	oxoo	
4	ooxo	
5	oxx	
6	oox	
7	oxo	
8	oooxox	
9	ooxxxxxx	
10	ooxxxxxx	
11	ooxooxox	
12	oxoxooxo	
13	oxooxoox	
14	oxooxoox	
15	oxxooxxx	
16	oxxooxxx	
17	oxxooxxx	
18	oxxooxxx	
19	oxxxxoox	
20	oxxxxoox	

# Assigning arpeggiator settings to the knobs (user page)

You can select which arpeggiator messages are assigned to the knobs, and register them on a dedicated page (the user page). This page is used for customizing the settings to control the knobs.

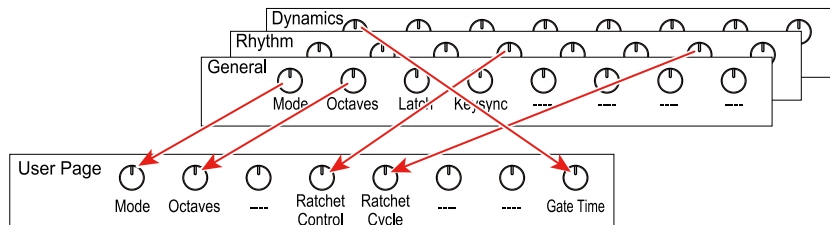

*Tip:* You can use KORG Kontrol Editor as well to register the data. For details, visit the Korg website ([www.korg.com](http://www.korg.com)).

## Assigning parameters to a user page

Here's an example of how to assign arpeggiator settings to the user page. This shows how to assign "Pattern" on edit screen page 2 (knob 3) to knob 1 of the user page.

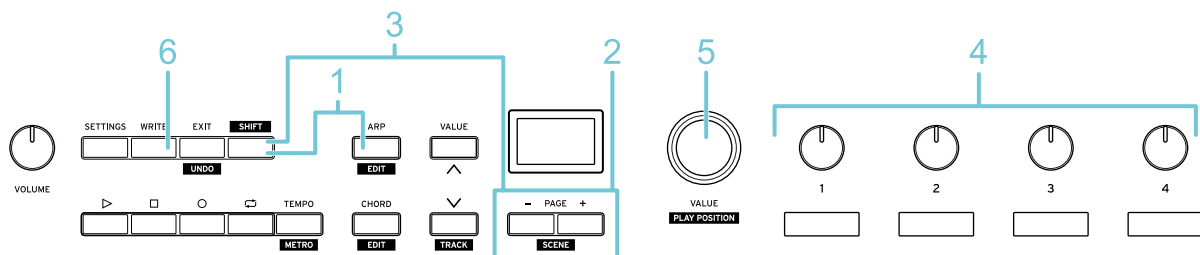

- 1 Press the ARP button while holding down the SHIFT button. The arpeggiator edit screen (page 1) is shown.
- 2 Press the PAGE -/+ buttons to access the page containing the setting you want to assign. In this example, we go to page 2 where "Pattern" is.

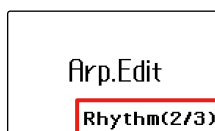

- 3 Press the WRITE button while holding down the SHIFT button.

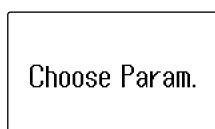

- 4 Turn the knob you want to register to the user page. The sub display that corresponds to that knob blinks. Turn knob 3 to select "Pattern".

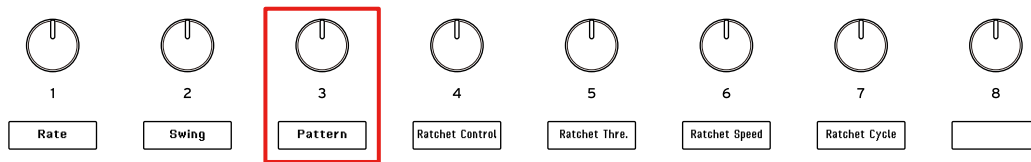

- Turn the VALUE dial to select the user page knob where you want to register the settings on the main display.  
In this example, select “UsrPg Knob1” (knob 1).

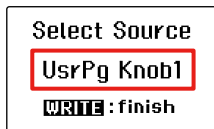

Indication	Controllers
UsrPg Knob1-UsrPg Knob8	Knobs 1-8
None	No assignment

- To register, press the WRITE button.  
Press the EXIT button to return to the main screen.

**⚠** The user page settings are included in the scene data. Any settings that you’ve edited are lost if you turn off the power or select another scene without saving it.  
→ [Switching between scenes](#)

## Recalling the user page

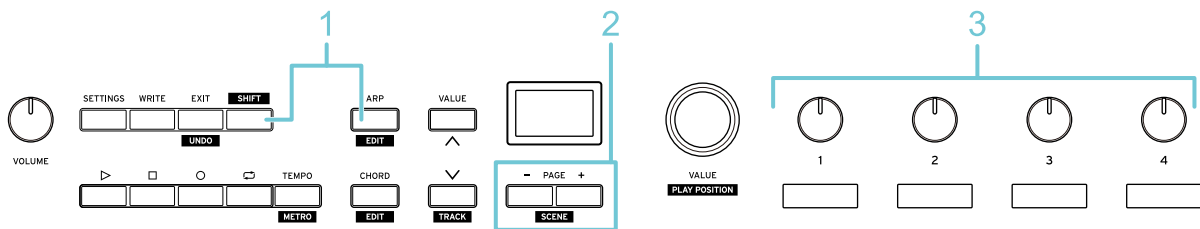

- Press the ARP button while holding down the SHIFT button to show the arpeggiator edit screen.
- Press the PAGE +/- buttons to select “User Page”.



*Tip:* The arpeggiator user page is only shown when it is registered.

- Turn the knob to control the setting that you’ve assigned.

## Resetting the user page

Here’s how to reset all of the settings of the user page to their unregistered state.



## Playing chords by pressing a single key (chord mode)

---

With chord mode, you can assign a chord to the keyboard and play it just by using one finger. When chord mode is turned on, a chord is assigned for every C to B range on the keyboard.

- [Playing chords](#)
- [Changing chord sets and how the chords play](#)
- [Registering the chords you like \(user chords\)](#)

## Playing chords

---

Here's how to turn on chord mode and play chords with just one finger. To do this, first get your sound generator or similar device ready to play.

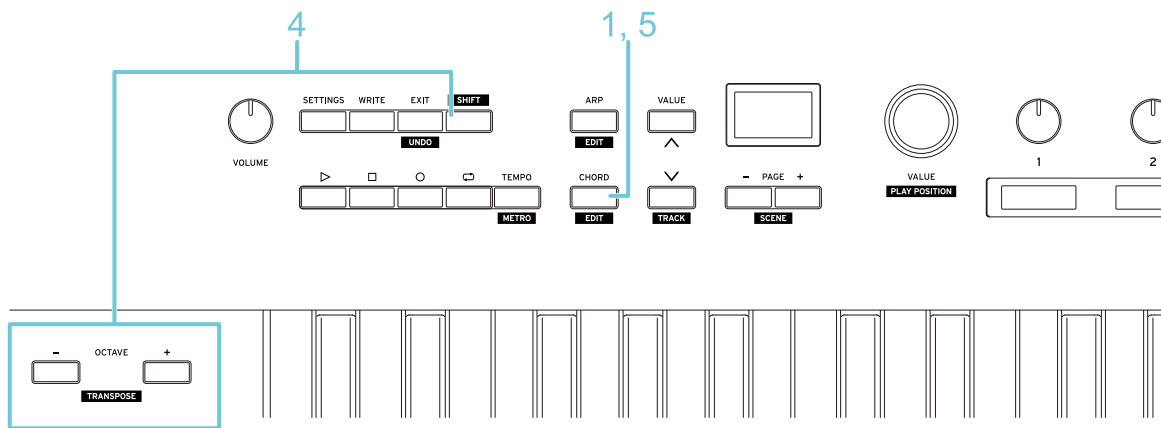

- 1** Press the CHORD button to turn chord mode ON (the button lights up). A chord is assigned to the keyboard.
- 2** Press a key.  
The most commonly used chords are preregistered to the white keys. You can create easy chord progression ideas by combining the chords assigned to the white keys.
- 3** Press another key to hear that chord.  
This plays a different chord. If you press a key in a different octave, a chord in that octave is played.
- 4** To transpose the chord, press the OCTAVE – or + button while holding down the SHIFT button.
- 5** To turn chord mode off, press the CHORD button. The button goes dark.

*Tip:* You can change the chords that are assigned to the keys.

→ [Changing chord sets and how the chords play](#)

*Tip:* When both chord mode and the arpeggiator are on, you can play the arpeggiator using the chords generated in chord mode.



## Changing chord sets and how the chords play

For chord mode, a different chord is assigned to each key (note slots C-B) over the range of one octave. If you press a key in a different octave, a chord in that octave is played.

You can play a variety of chords by switching between chord combinations (chord sets) and playing methods.

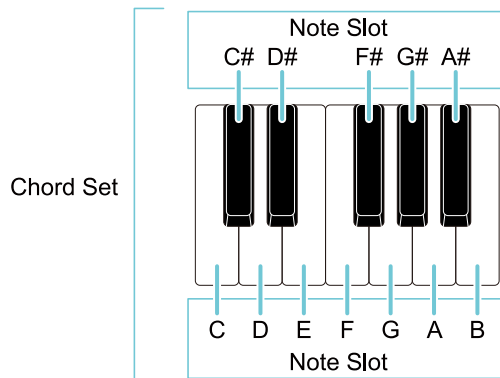

There are two types of chord sets: preset chord sets and user chord sets. You can register the chord sets you've configured into the user chords sets (User 01-User 32).

- [Preset chord sets \(chord mode\)](#)
- [Registering the chords you like \(user chords\)](#)

Aside from making all the notes in a chord play together, you can also make them play more loosely, as if you were strumming a guitar.

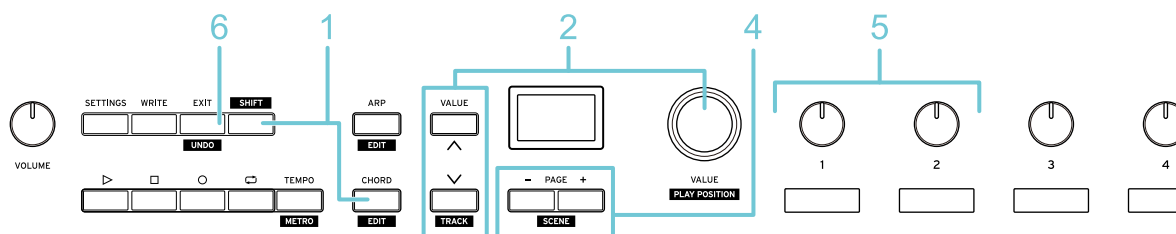

- 1 Press the CHORD button (the button blinks) while holding down the SHIFT button. The chord mode edit screen (page 1) is shown.

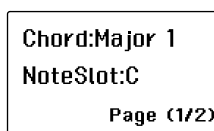

- 2 Use the VALUE dial or VALUE buttons to select a chord set.
- 3 Press a key on the keyboard (from C to B) to play the registered chord. The currently selected note slot is indicated on the main display.

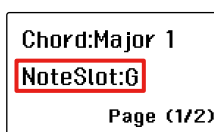

The chord registered to that note slot is shown in the sub display. Turn the knobs to change the various notes.

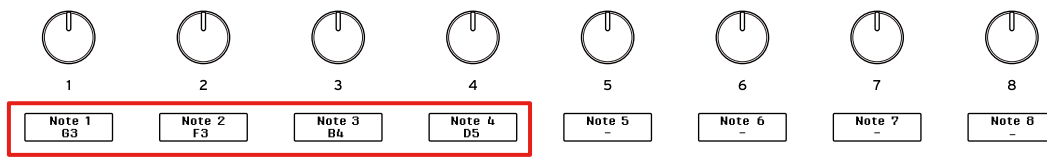

- 4 For a strumming effect, press the PAGE -/+ buttons to access page 2 on the edit screen.

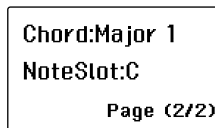

- 5 Turn knobs 1-2 to adjust how the strumming effect is applied.

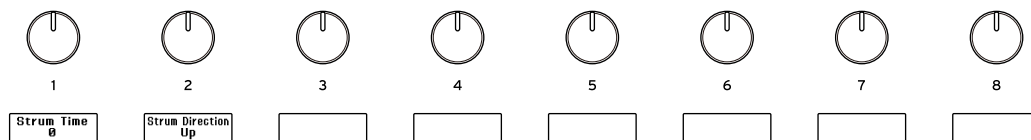

### Knob 1 [Strum Time]

Specifies how the strumming effect works.

**0:** No effect

**1-100:** Increasing this value makes the effect more prominent.

### Knob 2 [Strum Direction]

Sets the order in which the notes are played.

**Up:** The chord plays up from lower notes to higher notes.

**Down:** The chord plays down from higher notes to lower notes.

**Up&Down:** The direction toggles between “Up” and “Down” each time you press a key.

**Random:** The direction changes randomly (either “Up” or “Down”) each time you press a key.

**Velocity:** The direction toggles between “Up” and “Down” according to how hard you play the keys (velocity).

- 6 To finish editing, press the EXIT button.  
The display returns to the main screen.

## Registering the chords you like (user chords)

You can register the chords you like as “user chords”. A chord of up to eight notes can be registered in each note slot.

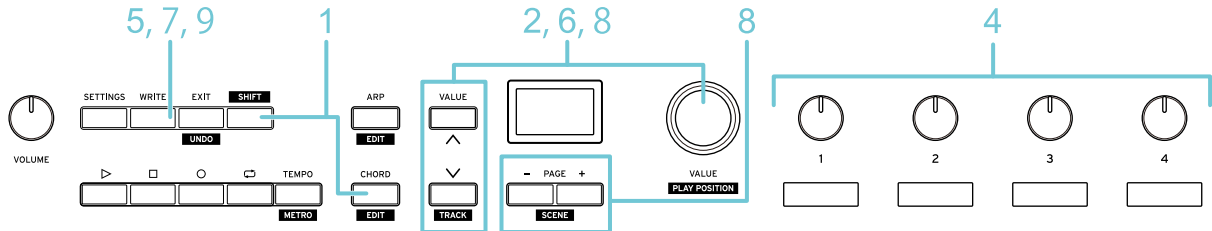

- 1 Press the CHORD button while holding down the SHIFT button to show the chord mode edit screen (page 1).
- 2 Use the VALUE dial or VALUE buttons to select a chord set.



- 3 Press a key from C to B to select the note slot where you want to register the chord.
- 4 Turn knobs 1-8 to set the notes in the chord.

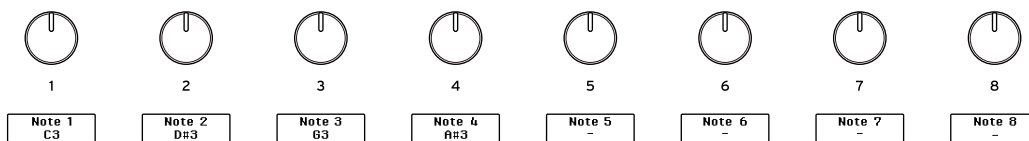

*Tip:* You can also specify the chord notes by playing the keys. When you play the chord notes while holding down the SHIFT button and then release the SHIFT button, the chord is set in the note slot that you selected in step 3.

- 5 To register the chord, press the WRITE button. The screen for selecting the save destination appears.
- 6 Turn the VALUE dial to select the user chord (User 01-User 32) for the save destination.



- 7 Press the WRITE button again. The screen for inputting the name appears.

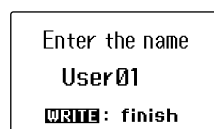

- 8 Use the VALUE dial and the PAGE -/+ buttons to input the name for your user chord. You can use the VALUE dial to edit the characters, and use the PAGE -/+ buttons to change the input position.
- 9 To save, press the WRITE button. Press the EXIT button to return to the main screen.

# Managing data and operations

---

The Keystage uses two types of setting data.

## Global data

This section shows you how to configure the overall settings of the Keystage, such as the settings related to MIDI, the keyboard, how the pedals work and so on.

This is the setting data for the keyboard velocity curves, power-saving functions and so on. Switching between scenes has no effect on the global data settings.

- Settings on the settings screen
- User chords registered in chord mode

The global data is saved automatically when you turn off the power (or unplug the USB cable).

→ [Configuring the overall operations of the Keystage](#)

## Scene data

This is setting data for the knobs, arpeggiator and so on. You can save or recall this setting data in bulk as a scene.

- User page settings
- Arpeggiator settings
- Chord mode settings (Chord Set, Strum Time, Strum Direction)
- Keyboard settings (MIDI Channel, Octave, Transpose)

 After editing the settings, if you turn off the power or select another scene without saving it, the changes are lost. If you want to reuse your edited settings, save the data to a scene.

→ [Switching between scenes](#)

Use KORG KONTROL Editor to manage and edit these parameters, and to make settings that are not available from the panel.

→ [Using KORG KONTROL Editor](#)

The app also lets you adjust (calibrate) the pedals, restore the settings to their default state and so on.

→ [Adjusting the pedals](#)

→ [Restoring the Keystage to factory-set default settings](#)

# Configuring the overall operations of the Keystage

Configure the overall settings of the Keystage from the settings screen.

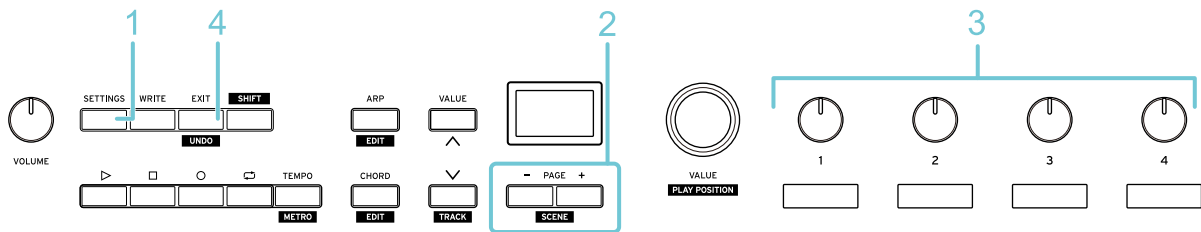

- 1 Press the SETTINGS button (the button lights up). The settings screen (page 1) appears.

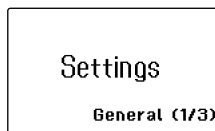

The settings screen consists of three pages.

- **Page 1 (General):** configures the overall settings for the Keystage.
- **Page 2 (Keyboard):** configures the keyboard-related settings.
- **Page 3 (Pedal):** configures the pedal-related settings.

- 2 Press the PAGE -/+ buttons to access the page containing the setting you want to edit.

- 3 Turn knobs 1-8 to edit the settings that you've assigned to the knobs.

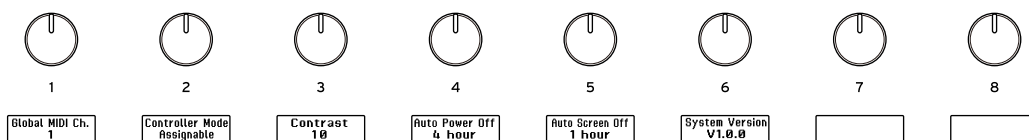

- 4 To finish editing, press the EXIT button. The display returns to the main screen.

## Overall settings (MIDI, auto power-off, etc.)

### Knob 1 [Global MIDI Ch.]

Specifies the MIDI channel on which the Keystage transmits and receives MIDI data.

**1-16:** MIDI channels 1-16

### Knob 2 [Controller Mode]

Sets the DAW that's controlled by the Keystage. If you want to use KORG Kontrol Editor to customize the settings for the transport buttons, select "Assignable".

### Knob 3 [Contrast]

Adjusts the brightness of the main and sub displays.

**1-10:** Larger values make the displays brighter.

### **Knob 4 [Auto Power Off]**

Sets whether the Keystage automatically turns off when the front panel or keyboard are not operated, or when MIDI is not received or transmitted.

**Disabled:** The auto power off function is disabled.

**1 hour, 2 hours, 3 hours, 4 hours:** Auto power off is enabled after one, two, three or four hours.

### **Knob 5 [Auto Screen Off]**

Sets whether the main or sub displays automatically turn off when the front panel or keyboard are not operated, or when MIDI is not received or transmitted.

**Disabled:** The auto screen off function is disabled.

**1 min, 5 min, 15 min, 30 min, 1 hour, 2 hours, 3 hours, 4 hours:**

Sets a value from one minute to four hours.

### **Knob 6 [System Version]**

Shows the system version for this instrument.

## **| Keyboard-related settings (velocity curve, etc.)**

### **Knob 1 [Velocity Curve]**

Use the velocity curve to adjust the responsiveness of the keyboard (the playing sensitivity) within a range of -10 to +10.

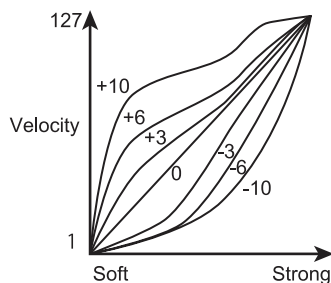

### **Knob 2 [AT MODE]**

Sets how aftertouch works.

**Off:** aftertouch is disabled.

**Channel:** channel aftertouch is used.

**Polyphonic:** polyphonic aftertouch is used.

**MPE:** set this when you are using a sound generator that supports MIDI Polyphonic Expression.

### Knob 3 [AT Curve]

Use the aftertouch curve to adjust the aftertouch characteristics within a range of -10 to +10.

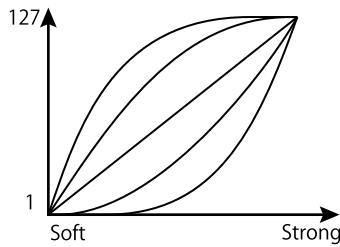

### Knob 4 [AT Threshold]

Sets the threshold (0-127) for aftertouch. Aftertouch is applied when you press into the keyboard at a strength that exceeds this value.

### Knob 5 [AT Max]

Sets the maximum value (0-127) for aftertouch.

## | Pedal-related settings

*Note:* You can adjust (calibrate) the damper and expression pedals so that they work more accurately.

→ [Adjusting the pedals](#)

### Knob 1 [Pedal 1 Type]

Sets which type of pedal is used for pedal 1 (the pedal connected to the DAMPER jack).

**Damper Pedal:** damper pedal (DS-1H, PS-1, PS-3)

**Exp.Pedal:** expression pedal (EXP-2, XVP-20)

### Knob2 [Pedal 1 Mode]

Configures the function operated by pedal 1 (the pedal connected to the DAMPER jack).

**Damper:** damper pedal

**Expression:** expression pedal

**CC:** control change messages

**Program Up:** program change + 1

**Program Down:** program change -1

### Knob3 [Pedal 1 CC#]

This specifies the value of the control change number that is used when "Pedal 1 Mode" (knob 2) is "CC".

### **Knob4 [Pedal 1 Curve]**

Adjusts the curve characteristics when pedal 1 is pressed, within a range of -10 to +10. This does not work when a pedal switch is connected.

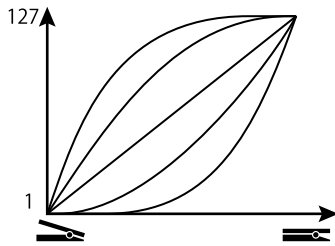

### **Knob 5 [Pedal 2 Type]**

Sets which type of pedal is used for pedal 2 (the pedal connected to the EXPRESSION jack). The setting values are the same as "Pedal 1 Type".

### **Knob 6 [Pedal 2 Mode]**

Configures the function operated by pedal 2 (the pedal connected to the EXPRESSION jack). The setting values are the same as "Pedal 1 Mode".

### **Knob 7 [Pedal 2 CC#]**

This specifies the value of the control change number that is used when "Pedal 2 Mode" (knob 6) is "CC".

### **Knob 8 [Pedal 2 Curve]**

Adjusts the curve characteristics when pedal 2 is pressed, within a range of -10 to +10. The setting values are the same as "Pedal 1 Curve".



## Switching between scenes

You can save or recall the knob or arpeggiator settings (scene data) in bulk as a scene.

→ [Scene data](#)

Sixteen scenes can be saved on the Keystage. By preparing a scene that matches each sound generator to be used and each performance situation, you can instantly switch between these settings on the Keystage.

Scenes 1-6 have preset user pages for use with software sound generators. Select the scene that matches the software sound generator you're using.

**Scene 1:** wavestate native

**Scene 2:** opsix native

**Scene 3:** modwave native

**Scene 4:** microKORG

**Scene 5:** TRITON

**Scene 6:** Polysix

*Note:* The wavestate native LE software is bundled with the Keystage. All other software sound generators can be purchased separately.

**⚠** You are free to edit the contents of scenes 1-6. However, if the user page settings differ from the factory default settings, you may not be able to properly control a software sound generator with this instrument.

*Tip:* You can use KORG KONTROL Editor to manage and edit the scenes. Download the software from the Korg website, and then set it up according to the instructions in the supplied document.

[https://www.korg.com/keystage\\_editor/](https://www.korg.com/keystage_editor/)

## Saving a Scene

Here's how to save the current sound settings to a scene. Make the settings on the Keystage as you want them to be saved, and then follow these steps.

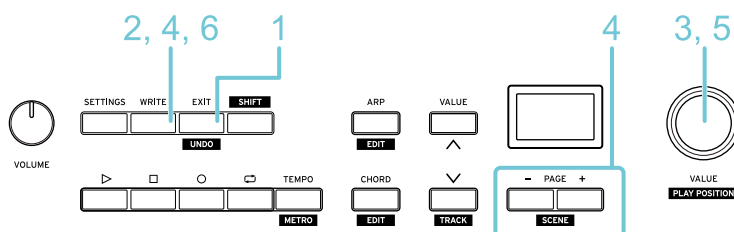

- 1** Press the EXIT button to access the main screen.
- 2** Press the WRITE button.  
The screen for selecting the save destination appears.

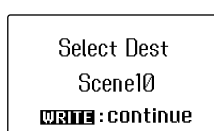

- 3** Turn the VALUE dial to select the number of the destination where you wish to save the scene.

- 4 Press the WRITE button again.  
The screen for inputting the scene name appears.

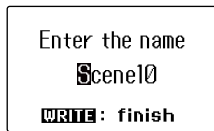

- 5 Use the VALUE dial and the PAGE -/+ buttons to input the scene name.  
You can use the VALUE dial to edit the characters, and use the PAGE -/+ buttons to change the input position.
- 6 To save, press the WRITE button.  
Once the data is saved, the message "Saved!" appears.

## Recalling a scene

Recalls a saved scene.

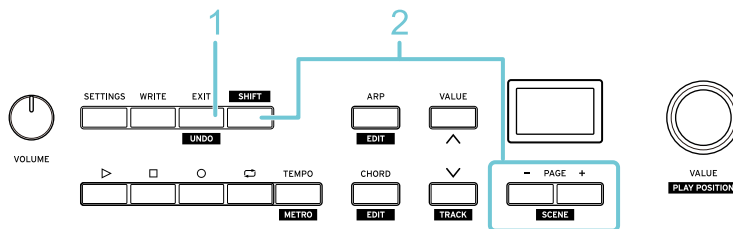

- 1 Press the EXIT button to access the main screen.
- 2 Press either of the PAGE -/+ buttons while holding down the SHIFT button to select a scene.

## Using KORG KONTROL Editor

---

You can use KORG KONTROL Editor to manage and edit the parameters of the Keystage, and to make settings that are not available from the panel. Download this software from the Korg website.

[https://www.korg.com/keystage\\_editor/](https://www.korg.com/keystage_editor/)

*Tip:* For details on installing and using KORG KONTROL Editor, refer to the Owner's Manual included with the software.

The parameters that are only available from KORG KONTROL Editor are shown below. When you set the MIDI channel to "Global", the instrument transmits data via the global MIDI channel.

### | Keyboard (keyboard settings)

**MIDI Ch:** Specifies the MIDI channel (1-16 or Global) used for transmitting performance data.

**Octave:** Specifies the octave (-3-0-+3).

**Transpose:** Sets the transposition (-12-0-+12).

### | Wheel (modulation wheel settings)

**MIDI Ch:** Specifies the MIDI channel (1-16 or Global) used for transmitting controller data.

**Lower Value:** Specifies the value (0-127) that's applied when you move the modulation wheel all the way down.

**Upper Value:** Specifies the value (0-127) that's applied when you move the modulation wheel all the way up.

### | Encoder (DAW play position settings)

This sets what happens when you use the Keystage to move the play position of the DAW (by using the SHIFT button + VALUE dial). You can set the counterclockwise (REW) and clockwise (FF) motions for the VALUE dial separately.

→ [Operating the transport](#)

**MIDI Ch:** Specifies the MIDI channel (1-16 or Global) used for transmitting controller data.

**AssignType:** Selects whether to transmit a control change message (CC) or a note message (Note) when the dial is operated (NoAssign, CC, Note). This is disabled when you select "NoAssign".

**CC/Note Number:** Specifies the MIDI message (control change number or note number) to be transmitted when the dial is operated.

### | Knob (settings for knobs 1-8)

This configures what happens when you turn knobs 1-8. You can configure 128 knob settings (knobs 1-8 × 16 pages) individually.

**MIDI Channel:** Specifies the MIDI channel (1-16 or Global) used for transmitting controller data.

**Left Value:** Sets the value used (0-127) when the knob is turned all the way counterclockwise.

**Right Value:** Sets the value used (0-127) when the knob is turned all the way clockwise.

## | Button (settings for other DAW operations)

This sets what the transport buttons do when you operate them, and what happens when you switch between tracks or undo an operation.

→ [Operating the transport](#)

→ [Other DAW operations](#)

You can set this separately for the following operations.

- PLAY button (Play), STOP button (Stop), REC button (Rec), LOOP button (Loop), TEMPO button (Tempo), SHIFT button + TEMPO button (Metro), SHIFT button + EXIT button (Undo), SHIFT button + VALUE button (Track down, Track up)

**MIDI Ch:** Specifies the MIDI channel (1-16 or Global) used for transmitting controller data.

**AssignType:** Selects whether to transmit a control change message (CC) or a note message (Note) when the dial is operated (NoAssign, CC, Note). This is disabled when you select "NoAssign".

**Behavior:** Selects how the button behaves (Momentary or Toggle) when you operate it. When you set this to "Momentary", the "On Value" is transmitted when the button is pressed, and the "Off Value" is transmitted when the button is released. When you set this to "Toggle", each press of the button alternately transmits the "On Value" or the "Off Value".

**CC/Note Number:** Specifies the MIDI message (control change number or note number) to be transmitted when the button is operated.

**On Value, Off Value:** Specifies the value of the control change number (0-127) that is used when "CC/Note Number" is set to "CC". The timing at which the data is transmitted depends on the "Behavior" setting.

## | Property Exchange (MIDI 2.0 Property Exchange settings)

Property Exchange is a function for transmitting and receiving sound names, parameter names and the like as MIDI messages between devices. You can change how this works as necessary.

**Property Exchange Enable:** Enables or disables the Property Exchange function.

**Program Number Display:** Sets the program numbers sent via Property Exchange to be shown (Displayed) or not shown (Not Displayed).

## Adjusting the pedals

You can adjust (calibrate) the damper and expression pedals so that they work more accurately.

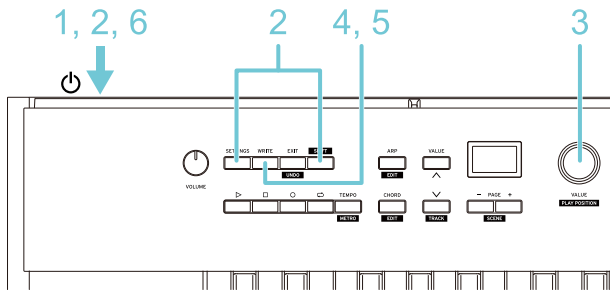

- 1 Turn off the power of the Keystage.
- 2 While holding down the SETTING button and the SHIFT button at the same time, turn on the power.

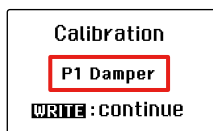

- 3 Turn the VALUE dial to select the pedal to calibrate, and press the WRITE button to confirm.
  - P1 Damper:** Damper pedal connected to the DAMPER jack
  - P1 Expression:** Expression pedal connected to the DAMPER jack
  - P2 Damper:** Damper pedal connected to the EXPRESSION jack
  - P2 Expression:** Expression pedal connected to the EXPRESSION jack

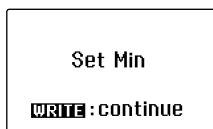

- 4 Set the minimum value for the pedal.
  - Damper pedal:** Press the WRITE button without pressing the pedal.
  - Expression pedal:** With the pedal pushed all the way down with your heel (the minimum setting), press the WRITE button.

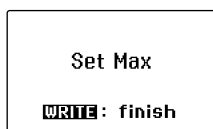

- 5 Set the maximum value for the pedal.
  - Damper pedal:** With the pedal pushed all the way down, press the WRITE button.
  - Expression pedal:** With the pedal pushed all the way up with your toes (the maximum setting), press the WRITE button.
- 6 Press the WRITE button to save the settings.

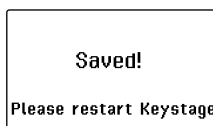

- 7 Turn off this instrument and then turn it on again.

*Note:* Wait at least five seconds when switching the power on and off again.

## Restoring the Keystage to factory-set default settings

---

Here's how to restore the settings of the Keystage to their factory-set defaults.

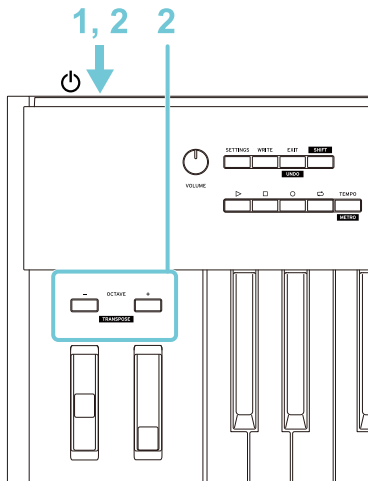

- 1 Turn off the power of the Keystage.
- 2 While holding down both the OCTAVE -/+ buttons, turn on the Keystage. This resets the instrument's settings, after which the power turns on.

## Appendices

---

- [Troubleshooting](#)
- [Preset chord sets \(chord mode\)](#)
- [Specifications](#)
- [Operating requirements \(for USB connection\)](#)



## Troubleshooting

---

### **The instrument does not turn on**

- If you connect the Keystage to your computer via a USB hub, it may not turn on due to insufficient power. In this case, connect the Keystage directly to the USB port on your computer without going through a USB hub.
- There may be a problem with the USB cable currently used. Check if the Keystage can be turned on using the USB cable that originally came with this instrument.
- When connecting to an iPad/iPhone with a Lightning to USB camera adapter, connect an AC adapter (sold separately).

### **No audio is output**

- Check whether the Keystage is correctly selected in the audio settings of your application as the output destination.
- When using a Windows PC, an audio driver must be installed. Before connecting via USB, download the driver from the Korg website ([www.korg.com](http://www.korg.com)), and install the driver on your computer.

### **The software doesn't respond.**

- Check whether the Keystage is correctly specified in the MIDI port settings of your application.
- To use the Keystage with your DAW or software sound generator, you need to make the proper settings in your application. Follow the directions in the application's owner's manual to configure these settings.
- Your application may not support some functions. Check the instruction manual for your application.
- Make sure that the MIDI channel for messages transmitted by the Keystage is the same as the MIDI reception channel in the application.

### **The buttons or controllers aren't working correctly**

- Your application may not support some functions, or it may operate differently (or not at all) in some cases. Check the instruction manual for your application to see whether the functions you want to use are supported.

## Preset chord sets (chord mode)

The most commonly used chords are preregistered to the white keys for the preset chord sets. You can create easy chord progression ideas by combining the chords assigned to the white keys. Most of the preset chords sets are based around C as their tonal center. To play the chords in a different key, use the keyboard transpose function.

No.	Chord set	Note slot											Example of notes played	
		C	C#	D	D#	E	F	F#	G	G#	A	A#		B
1	Major 1	Cm7	C#dim7	Dm7	D#dim7	Em7	Fm7	F#m7b5	G7	G#dim7	Am7	A#dim7	Bm7b5	C A D G, D G E A, F E D A
		G4	G4	A4	A4	B4	C5	C5	D5	D5	E5	E5	F5	
		E4	E4	F4	F#4	G4	A4	A4	B4	B4	C5	C#5	D5	
		B3	A#3	C4	C4	D4	E4	E4	F4	F4	G4	G4	A4	
		C3	C#3	D3	D#3	E3	F3	F#3	G3	G#3	A3	A#3	B3	
Basic chords that match the Ionian scale (melodies that use only white notes), known as "diatonic chords"														
2	Major 2	Cm7	C#dim7	D7	D#dim7	Em7	F#m7b5	F#7	Gm7	G#dim7	Am7	A#dim7	Bm7	C B A B
		G4	G4	A4	A4	B4	C5	C#5	D5	D5	E5	E5	F#5	
		E4	E4	F#4	F#4	G4	A4	A#4	B4	B4	C5	C#5	D5	
		B3	A#3	C4	C4	D4	E4	E4	F#4	F4	G4	G4	A4	
		C3	C#3	D3	D#3	E3	F#3	F#3	G3	G#3	A3	A#3	B3	
Major key chords that match the Lydian scale														
3	Major 3	C7	C#7	Dm7	D#7	Em7b5	Fm7	F#7	Gm7	G#7	Am7	A#7	A#M7	D F G A
		G4	G#4	A4	A#4	A#4	C5	C#5	D5	D#5	E5	F5	F5	
		E4	F4	F4	G4	G4	A4	A#4	A#4	C5	C5	D5	D5	
		A#3	B3	C4	C#4	D4	E4	E4	F4	F#4	G4	G#4	A4	
		C3	C#3	D3	D#3	E3	F3	F#3	G3	G#3	A3	A#3	A#3	
Major key chords that match the Mixolydian scale														
4	minor 1	Cm7	C#M7	Dm7b5	D#m7	D#M7	Fm7	F#m7	Gm7	G#m7	G#M7	Am7b5	A#7	C F G A
		G4	G#4	G#4	A#4	A#4	C5	C#5	D5	D#5	D#5	D#5	F5	
		D#4	F4	F4	F#4	G4	G#4	A4	A#4	B4	C5	C5	D5	
		A#3	C4	C4	C#4	D4	D#4	E4	F4	F#4	G4	G4	G#4	
		C3	C#3	D3	D#3	D#3	F3	F#3	G3	G#3	G#3	A3	A#3	
Basic minor key chords that match the Aeolian scale														
5	minor 2	Cm7	C#m7	Dm7	D#m7	D#M7	F7	F#7	Gm7	G#m7	Am7b5	A#m7	A#M7	C F C F
		G4	G#4	A4	A#4	A#4	C5	C#5	D5	D#5	D#5	F5	F5	
		D#4	E4	F4	F#4	G4	A4	A#4	A#4	B4	C5	C#5	D5	
		A#3	B3	C4	C#4	D4	D#4	E4	F4	F#4	G4	G#4	A4	
		C3	C#3	D3	D#3	D#3	F3	F#3	G3	G#3	A3	A#3	A#3	
Minor key chords that match the Dorian scale														
6	minor 3	Cm7	C#7b5	Dm7b5	D#m7	D#M7	Fm7	F#dim7	G7	G#dim7	G#M7	A#7	Bdim7	F G C C A B C E
		G4	G4	G#4	A#4	A#4	C5	C5	D5	D5	D#5	F5	F5	
		D#4	F4	F4	F#4	G4	G#4	A4	B4	B4	C5	D5	D5	
		A#3	B3	C4	C#4	D4	D#4	D#4	F4	F4	G4	G#4	G#4	
		C3	C#3	D3	D#3	D#3	F3	F#3	G3	G#3	G#3	A#3	B3	
Minor key chords that match the harmonic minor scale														

No.	Chord set	Note slot											Example of notes played	
		C	C#	D	D#	E	F	F#	G	G#	A	A#		B
7	Kanon 1	C	C#	Dm	D#dim	Em	F	F#dim	G	G#	Am	A#	G/B	C G A E F C D G
		G4	G#4	A4	A4	B4	C5	C5	D5	D#5	E5	F5	G5	
		E4	F4	F4	F#4	G4	A4	A4	B4	C5	C5	D5	D5	
		C4	C#4	D4	D#4	E4	F4	F#4	G4	G#4	A4	A#4	B4	
		C3	C#3	D3	D#3	E3	F3	F#3	G3	G#3	A3	A#3	B3	
Canon chord progression, used by many hit songs														
8	Kanon 2	Cm9	C#9	D7b9	D#dim7	D#M9	Fm9	F#dim7	Gm9	G7b9b13	G#M9	Am7b5	Gm7/A#	C B A G F E D G#
		G4	G#4	A4	A4	A#4	C5	C5	D5	D#5	D#5	D#5	F5	
		D#4	F4	F#4	F#4	G4	G#4	A4	A#4	B4	C5	C5	D5	
		D4	D#4	D#4	D#4	F4	G4	F#4	A4	G#4	A#4	A4	A#4	
		A#3	B3	C4	C4	D4	D#4	D#4	F4	F4	G4	G4	G4	
C3	C#3	D3	D#3	D#3	F3	F#3	G3	G3	G#3	A3	A#3			
Dramatic canon chord progression in a minor key														
9	Cliche 1	C	C#7b5	Dm7	D#dim7	Em7	Fm6/C	F#m7b5/C	C	Fm/C	F/C	C7	CM7	C B A# A G# G F# F
		G4	G4	F4	F#4	G4	F4	E4	E4	F4	F4	G4	G4	
		E4	F4	C4	C4	D4	D4	A3	C4	C4	C4	E4	E4	
		C4	B3	A3	A3	B3	G#3	F#3	G3	G#3	A3	A#3	B3	
		C3	C#3	D3	D#3	E3	C3	C3	C3	C3	C3	C3	C3	
Major version of cliché chord progression that changes in semitone steps														
10	Cliche 2	Cm	Fm/C	D/C	CmM7	Cm	Fm6/C	Cdim7	Cm	G#/C	Cm6	Cm7	CmM7	C B A# A G# G F# F
		G4	F4	F#4	G4	D#4	F4	D#4	D#4	D#4	G4	G4	G4	
		D#4	C4	D4	D#4	C4	D4	A3	C4	C4	D#4	D#4	D#4	
		C4	G#3	A3	B3	G3	G#3	F#3	G3	G#3	A3	A#3	B3	
		C3	C3	C3	C3	C3	C3	C3	C3	C3	C3	C3	C3	
Minor version of cliché chord progression that changes in semitone steps														
11	Pop 1	C	A/C#	Dm	B/D#	Em	F	D/F#	G	E/G#	Am	A#	G/B	C G A A F C G G
		G4	A4	A4	B4	B4	C5	D5	D5	E5	E5	F5	G5	
		E4	E4	F4	F#4	G4	A4	A4	B4	B4	C5	D5	D5	
		C4	C#3	D3	D#3	E3	F3	F#3	G3	G#3	A3	A#3	B3	
		C3	C#3	D3	D#3	E3	F3	F#3	G3	G#3	A3	A#3	B3	
Diatonic triad chords, suitable for simple pop music														
12	Pop 2	C	C#7	Dm7	D#m	D#	F	F#7	Gm7	G#m	G#	A	A#	C D E E E D C C
		G4	G#4	A4	A#4	A#4	C5	C#5	D5	D#5	D#5	E5	F5	
		E4	F4	F4	F#4	G4	A4	A#4	A#4	B4	C5	C#5	D5	
		C4	B3	C4	D#4	D#4	F4	E4	F4	G#4	G#4	A4	A#4	
		C3	C#3	D3	D#3	D#3	F3	F#3	G3	G#3	G#3	A3	A#3	
Chords based on 90s rock music														
13	Pop 3	CM7	C#7	Dm7b5	D#m7	D#M7	Fm7	F#m7b5	Gm7	G7	G#M7	Am7b5	A#6	C C A A B B G G#
		G4	G#4	G#4	A#4	A#4	C5	C5	D5	D5	D#5	D#5	F5	
		E4	F4	F4	F#4	G4	G#4	A4	A#4	B4	C5	C5	D5	
		B3	B3	C4	C#4	D4	D#4	E4	F4	F4	G4	G4	G4	
		C3	C#3	D3	D#3	D#3	F3	F#3	G3	G3	G#3	A3	A#3	
Chords based on techno-pop and rock music														

No.	Chord set	Note slot											Example of notes played	
		C	C#	D	D#	E	F	F#	G	G#	A	A#		B
14	R&B 1	<b>Cm7</b>	<b>C#7</b>	<b>Dm7b5</b>	<b>D#m7</b>	<b>D#7</b>	<b>Fm7</b>	<b>F#dim7</b>	<b>G7</b>	<b>G#dim7</b>	<b>G#M7</b>	<b>A7</b>	<b>A#m7</b>	A A G G C C B E
		G4	G#4	G#4	A#4	A#4	C5	C5	D5	D5	D#5	E5	F5	
		D#4	F4	F4	F#4	G4	G#4	A4	B4	B4	C5	C#5	C#5	
		A#3	B3	C4	C#4	C#4	D#4	D#4	F4	F4	G4	G4	G#4	
		Chords that evoke the feeling of mellow R&B, city pop and K-pop												
15	R&B 2	<b>CM9</b>	<b>C#79</b>	<b>Dm9</b>	<b>D#m9</b>	<b>D#M9</b>	<b>Fm9</b>	<b>F#dim7</b>	<b>Gm7</b>	<b>G#m6</b>	<b>G#M9</b>	<b>Em7/A</b>	<b>Fm7/A#</b>	F G C C A B C C
		G4	G#4	A4	A#4	A#4	C5	C5	D5	D#5	D#5	E5	F5	
		E4	F4	F4	F#4	G4	G#4	A4	A#4	B4	C5	D5	D#5	
		D4	D#4	E4	F4	F4	G4	F#4	G4	G#4	A#4	B4	C5	
		Chords based on an R&B song with a floating feeling												
16	R&B 3	<b>Gm7/C</b>	<b>G#m7/C#</b>	<b>Am7/D</b>	<b>A#m7/D#</b>	<b>D#M9</b>	<b>Cm7/F</b>	<b>C#m7/F#</b>	<b>Dm7/G</b>	<b>D#m7/G#</b>	<b>G#M9</b>	<b>A#m9</b>	<b>A#M9</b>	C E F G
		F4	F#4	G4	G#4	A#4	A#4	B4	C5	C#5	D#5	F5	F5	
		D4	D#4	E4	F4	G4	G4	G#4	A4	A#4	C5	C#5	D5	
		A#3	B3	C4	C#4	F4	D#4	E4	F4	F#4	A#4	C5	C5	
		Inverted chords suitable for a gorgeous R&B sound												
17	Jazz 1	<b>CM9</b>	<b>C#M9</b>	<b>Dm9</b>	<b>D#m9</b>	<b>Em9</b>	<b>Fm9</b>	<b>F#9b13</b>	<b>Dm7/G</b>	<b>G#M9</b>	<b>A7#9b13</b>	<b>A#7913</b>	<b>B7913</b>	D E F G C C A A
		G4	G#4	A4	A#4	B4	C5	C5	D5	D#5	F5	G5	G#5	
		E4	F4	F4	F#4	G4	A4	A#4	C5	C5	C#5	D5	D#5	
		D4	D#4	E4	F4	F#4	G4	G#4	A4	A#4	C5	C5	C#5	
		Chords based on jazz music												
18	Jazz 2	<b>C6</b>	<b>C#dim7</b>	<b>Dm7</b>	<b>D#dim7</b>	<b>C6/E</b>	<b>Fdim7</b>	<b>F#dim7</b>	<b>C6/G</b>	<b>G#dim7</b>	<b>Am7</b>	<b>A#dim7</b>	<b>Bdim7</b>	C C# D D# E
		G4	G4	A4	A4	A4	B4	C5	C5	D5	E5	E5	F5	
		E4	E4	F4	F#4	G4	G#4	A4	A4	B4	C5	C#5	D5	
		A3	A#3	C4	C4	C4	D4	D#4	E4	F4	G4	G4	G#4	
		Big-band jazz-type chords												
19	Jazz 3	<b>CM9</b>	<b>C#7913</b>	<b>Dm9</b>	<b>D#M9</b>	<b>Em9</b>	<b>Fm9</b>	<b>F#7913</b>	<b>G7#9b13</b>	<b>G#M9</b>	<b>A7913</b>	<b>A#m9</b>	<b>B7913</b>	C B A# A G# G# F# F
		A#4	A#4	C5	D5	D5	D#5	D#5	D#5	D#5	F#5	F5	G#5	
		G4	F4	A4	A#4	B4	C5	A#4	B4	C5	C#5	C#5	D#5	
		D#4	D#4	F4	G4	G4	G#4	G#4	A#4	A#4	B4	C5	C#5	
		Jazz chords with a complicated feeling of tension												

No.	Chord set	Note slot											Example of notes played	
		C	C#	D	D#	E	F	F#	G	G#	A	A#		B
20	Blues 1	C79	C#79	D79	D#79	E79	F79	F#79	G79	G#79	A79	A#79	B79	C C F F C C G F# F F C C
		G4	G#4	A4	A#4	B4	C5	C#5	D5	D#5	E5	F5	F#5	
		D4	D#4	E4	F4	F#4	G4	G#4	A4	A#4	B4	C5	C#5	
		A#3	B3	C4	C#4	D4	D#4	E4	F4	F#4	G4	G#4	A4	
		Blues chords in a blues/jazz/funk style												
21	Blues 2	Cm7	C#7	Dm7b5	D#m7	D#7	Fm7	F#7	Gm7	G#m7	G#7	A7	A#7	C C F C G F C C
		A#4	B4	C5	C#5	C#5	D#5	E5	F5	F#5	F#5	G5	G#5	
		D#4	F4	G#4	F#4	G4	G#4	A#4	A#4	B4	C5	C#5	D5	
		C3	C#3	D3	D#3	D#3	F3	F#3	G3	G#3	G#3	A3	A#3	
		Blues chords in a minor key												
22	Latin	Cm	C#7	Dm7b5	D#dim7	D#M7	F7	F#dim7	G7b9b13	G#M7	Am7b5	Cm7/A#	Baug	C B A# A D D G G
		G5	F5	F5	F#5	G5	D#5	D#5	F5	G5	G5	G5	G5	
		D#5	B4	C5	C5	D5	C5	C5	D#5	D#5	D#5	D#5	D#5	
		C5	G#4	G#4	A4	A#4	A4	A4	B4	C5	C5	C5	B4	
		Chords based on Latin and salsa music												
23	Bossa	CM7	C#79	D79	D#79	E79	F69	F#7#11	F/G	G#7	A7b13	A#7	B713	C B A# A G# G F# F E D# D C# C
		G4	D#5	E5	F5	F#5	G5	E5	F5	D#5	F5	F5	G#5	
		E4	B4	C5	C#5	D5	D5	C5	C5	C5	C#5	D5	D#5	
		B3	F4	F#4	G4	G#4	A4	A#4	A4	F#4	G4	G#4	A4	
		Chords that impart a bossa nova feel												
24	Motion 1	CM9	C#m9	DM9	D#m9	EM9	Fm9	F#M9	Gm9	G#M9	Am9	A#M9	Bm9	C B A# A G# G F# F
		G4	G#4	A4	A#4	B4	C5	C#5	D5	D#5	E5	F5	F#5	
		E4	E4	F#4	F#4	G#4	G#4	A#4	A#4	C5	C5	D5	D5	
		D4	D#4	E4	F4	F#4	G4	G#4	A4	A#4	B4	C5	C#5	
		Chords that descend in semitones, used in the bridge section of songs												
25	Motion 2	CM7	C#7sus4	DM7	D#7sus4	EM7	F7sus4	F#M7	G7sus4	G#M7	A7sus4	A#M7	B7sus4	C B A# A G# G F# F
		B4	B4	C#5	C#5	D#5	D#5	F5	F5	G5	G5	A5	A5	
		G4	G#4	A4	A#4	B4	C5	C#5	D5	D#5	E5	F5	F#5	
		E4	F#4	F#4	G#4	G#4	A#4	A#4	C5	C5	D5	D5	E5	
		Chords that descend in semitones, in French pop music style												

No.	Chord set	Note slot											Example of notes played	
		C	C#	D	D#	E	F	F#	G	G#	A	A#		B
26	Hit 1	<b>CM9</b>	<b>C#M9</b>	<b>DM9</b>	<b>D#M9</b>	<b>EM9</b>	<b>FM9</b>	<b>F#M9</b>	<b>GM9</b>	<b>G#M9</b>	<b>AM9</b>	<b>A#M9</b>	<b>BM9</b>	----
		D5	D#5	E5	F5	F#5	G5	G#5	A5	A#5	B5	C6	C#6	
		B4	C5	C#5	D5	D#5	E5	F5	F#5	G5	G#5	A5	A#5	
		G4	G#4	A4	A#4	B4	C5	C#5	D5	D#5	E5	F5	F#5	
		E4	F4	F#4	G4	G#4	A4	A#4	B4	C5	C#5	D5	D#5	
		C3	C#3	D3	D#3	E3	F3	F#3	G3	G#3	A3	A#3	B3	
Major 7th/9th chords moving in parallel														
27	Hit 2	<b>C7#9</b>	<b>C#7#9</b>	<b>D7#9</b>	<b>D#7#9</b>	<b>E7#9</b>	<b>F7#9</b>	<b>F#7#9</b>	<b>G7#9</b>	<b>G#7#9</b>	<b>A7#9</b>	<b>A#7#9</b>	<b>B7#9</b>	----
		D#5	E5	F5	F#5	G5	G#5	A5	A#5	B5	C6	C#6	D6	
		A#4	B4	C5	C#5	D5	D#5	E5	F5	F#5	G5	G#5	A5	
		E4	F4	F#4	G4	G#4	A4	A#4	B4	C5	C#5	D5	D#5	
		C3	C#3	D3	D#3	E3	F3	F#3	G3	G#3	A3	A#3	B3	
7th/#9 parallel chord progressions, also used in breaks and hits														
28	Hit 3	<b>Cm9</b>	<b>C#m9</b>	<b>Dm9</b>	<b>D#m9</b>	<b>Em9</b>	<b>Fm9</b>	<b>F#m9</b>	<b>Gm9</b>	<b>G#m9</b>	<b>Am9</b>	<b>A#m9</b>	<b>Bm9</b>	----
		G4	G#4	A4	A#4	B4	C5	C#5	D5	D#5	E5	F5	F#5	
		D#4	E4	F4	F#4	G4	G#4	A4	A#4	B4	C5	C#5	D5	
		D4	D#4	E4	F4	F#4	G4	G#4	A4	A#4	B4	C5	C#5	
		A#3	B3	C4	C#4	D4	D#4	E4	F4	F#4	G4	G#4	A4	
		C3	C#3	D3	D#3	E3	F3	F#3	G3	G#3	A3	A#3	B3	
Minor 7th/9th chords moving in parallel														
29	Hit 4	<b>Gm7/C</b>	<b>C#m7/C#</b>	<b>Am7/D</b>	<b>A#m7/D#</b>	<b>Bm7/E</b>	<b>Cm7/F</b>	<b>C#m7/F#</b>	<b>Dm7/G</b>	<b>D#m7/G#</b>	<b>Em7/A</b>	<b>Fm7/A#</b>	<b>F#m7/B</b>	----
		F4	F#4	G4	G#4	A4	A#4	B4	C5	C#5	D5	D#5	E5	
		D4	D#4	E4	F4	F#4	G4	G#4	A4	A#4	B5	C5	C#5	
		A#3	B3	C4	C#4	D4	D#4	E4	F4	F#4	G4	G#4	A4	
		G3	G#3	A3	A#3	B3	C4	C#4	D4	D#4	E4	F4	F#4	
		C3	C#3	D3	D#3	E3	F3	F#3	G3	G#3	A3	A#3	B3	
Inverted chords moving in parallel														
30	Hit 5	<b>C7sus4</b>	<b>C#7sus4</b>	<b>D7sus4</b>	<b>D#7sus4</b>	<b>E7sus4</b>	<b>F7sus4</b>	<b>F#7sus4</b>	<b>G7sus4</b>	<b>G#7sus4</b>	<b>A7sus4</b>	<b>A#7sus4</b>	<b>B7sus4</b>	----
		A#3	B3	C4	C#4	D4	D#4	E4	F4	F#4	G4	G#4	A4	
		F3	F#3	G3	G#3	A3	A#3	B3	C4	C#4	D4	D#4	E4	
		C3	C#3	D3	D#3	E3	F3	F#3	G3	G#3	A3	A#3	B3	
Chords called "quartal triads" with 4ths/7ths, moving in parallel														
31	Hit 6	<b>C 5th</b>	<b>C# 5th</b>	<b>D 5th</b>	<b>D# 5th</b>	<b>E 5th</b>	<b>F 5th</b>	<b>F# 5th</b>	<b>G 5th</b>	<b>G# 5th</b>	<b>A 5th</b>	<b>A# 5th</b>	<b>B 5th</b>	----
		C4	C#4	D4	D#4	E4	F4	F#4	G4	G#4	A4	A#4	B4	
		G3	G#3	A3	A#3	B3	C4	C#4	D4	D#4	E4	F4	F#4	
		C3	C#3	D3	D#3	E3	F3	F#3	G3	G#4	A3	A#3	B3	
Chords called "power chords" with 5ths, moving in parallel														
32	Hit Oct	<b>C Oct</b>	<b>C# Oct</b>	<b>D Oct</b>	<b>D# Oct</b>	<b>E Oct</b>	<b>F Oct</b>	<b>F# Oct</b>	<b>G Oct</b>	<b>G# Oct</b>	<b>A Oct</b>	<b>A# Oct</b>	<b>B Oct</b>	----
		C5	C#5	D5	D#5	E5	F5	F#5	G5	G#5	A5	A#5	B5	
		C4	C#4	D4	D#4	E4	F4	F#4	G4	G#4	A4	A#4	B4	
		C3	C#3	D3	D#3	E3	F3	F#3	G3	G#3	A3	A#3	B3	
		C2	C#2	D2	D#2	E2	F2	F#2	G2	G#2	A2	A#2	B2	
Chords playing over four octaves in unison, moving in parallel														

# Specifications

---

## Keyboard

Keystage-49: Polytouch keyboard\*, 49 keys

Keystage-61: Polytouch keyboard\*, 61 keys

Features velocity sensitivity, aftertouch and polyphonic aftertouch

Velocity curves: 21 (-10-0-+10)

Octave range: 7 (-3-0-+3)

## Controllers

Pitch bend wheel, modulation wheel, parameter control knobs × 8

VOLUME knob, SETTINGS button, WRITE button, EXIT button, SHIFT button, ARP button, CHORD button, VALUE ^/∨ buttons, VALUE dial, PAGE -/+ buttons, transport buttons, TEMPO button, OCTAVE -/+ buttons

## Display

Main display: organic EL (electro-luminescence) display

Sub display: organic EL displays × 8

## Scenes

No. of scenes: 16

## Arpeggiator

Arpeggio rhythm patterns: 20

## Chord mode

Preset chord sets: 32

User chord sets: 32

## Input/output jacks

USB port, MIDI (IN, OUT connectors), EXPRESSION jack, DAMPER jack, AUDIO OUT (L/MONO, R jacks), headphone jack

## Audio output

AUDIO OUT (L/MONO, R): 6.3 mm TS phone jack (unbalanced)

Headphones: 6.3 mm stereo phone jack

## Control inputs

DAMPER (half-damper supported)

EXPRESSION

## MIDI

IN, OUT

## USB

Type B

MIDI/audio interface

MIDI: 1 in/1 out

Audio: 2 ch out

Audio format: 44.1 kHz, 16-bit

## Power supply

USB bus power or AC adapter (DC 9 V, )

**Current consumption**

5 V/500 mA or less (when powered via USB)

**Power consumption**

4 W (when using an AC adapter)

**Dimensions (W × D × H)**

Keystage-49: 814 × 234 × 82 mm/32.05" × 9.21" × 3.23"

Keystage-61: 979 × 234 × 82 mm/38.54" × 9.21" × 3.23"

**Weight**

Keystage-49: 4.2 kg/9.26 lb

Keystage-61: 5.0 kg/11.02 lb

**Included items**

USB cable (Type A-Type B), expansion plate, Quick Start Guide, Precautions

**Accessories (sold separately)**

Volume/expression pedal XVP-20

Foot controller EXP-2

Damper pedal DS-1H

Pedal switch PS-1, PS-3

AC adapter (DC 9 V, )

\*Specifications and appearance are subject to change without notice for improvement.

\* **Polytouch**<sup>®</sup> is a registered trademark of Medeli, developed with Ashun Sound Machines.

\*All product names and company names are the trademarks or registered trademarks of their respective owners.



## **Operating requirements (for USB connection)**

---

See the Korg website for the latest information on OS support.

<https://www.korg.com/support/os/>

# MIDI Implementation Chart

Function...		Transmitted	Recognized	Remarks
Basic Channel	Default	1–16	1–16	Memorized
	Changed	1–16	1–16	
Mode	Default	X	X	
	Messages	O	X	
	Altered	*****		
Note Number		0–127	X	
	True voice	*****	X	
Velocity	Note On	O 9n, V=1–127	X	
	Note Off	O 8n, V=1–64	X	
After Touch	Key's	O	X	
	Channel	O	X	
Pitch Bend		O	X	
Control Change		0–127	X	
		O		
Program Change		O 0–127	X	
	True Number	*****	*****	
System Exclusive		O	O	*1, *3
System Common	Song Position	X	X	
	Song Select	X	X	
	Tune Request	X	X	
System Real Time	Clock	O	O	
	Commands	X	X	
Aux Messages	Local On/Off	O	X	*2
	All Notes Off	O	X	
	Active Sensing	O	X	
	System Reset	X	X	
<b>Notes</b> *1: In addition to Korg exclusive messages, also responds to inquiry messages. *2: This is only transmitted via the MIDI OUT connector (USB-MIDI not supported). *3: Supports MIDI 2.0 Property Exchange.				

Mode 1: Omni On, Poly  
 Mode 3: Omni Off, Poly

Mode 2: Omni On, Mono  
 Mode 4: Omni Off, Mono

O: Yes  
 X: No

Consult your local Korg distributor for more information on MIDI implementation.