

# Instruction Manual

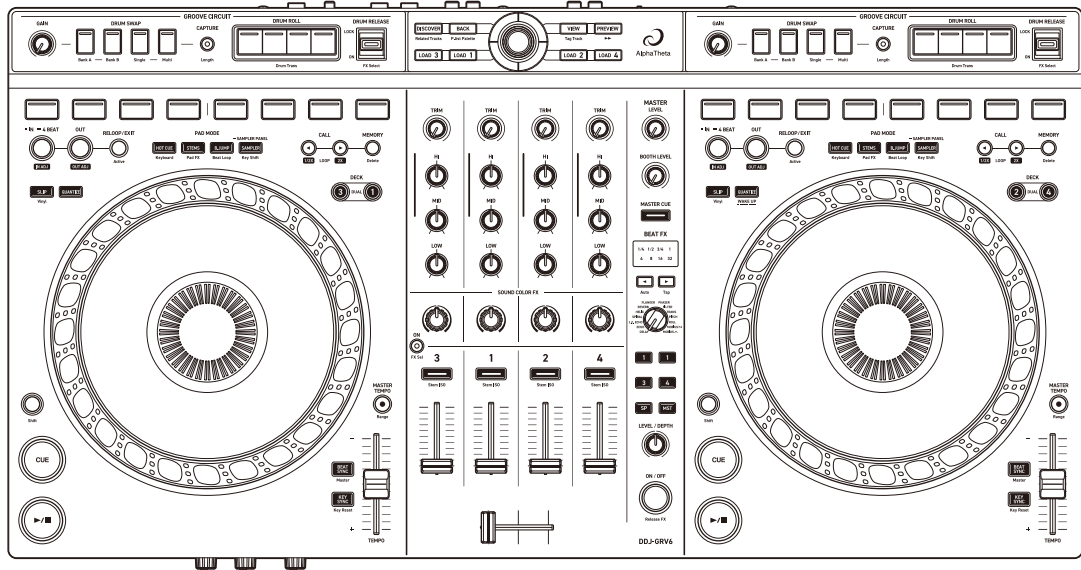

DJ Controller

# DDJ-GRV6

[alphatheta.com/support/](http://alphatheta.com/support/)

[rekordbox.com](http://rekordbox.com)

[serato.com](http://serato.com)

For FAQ and other support information for this product, visit the websites above.

---

---

## How to read this manual

Thank you for choosing this AlphaTheta product.

Be sure to read this manual, the Quick Start Guide and the Precautions for Use which are included with this product. These documents include important information that you should understand before using the unit. In particular, be sure to read the IMPORTANT SAFETY INSTRUCTIONS.

- In this manual, the names of buttons, knobs, and terminals that appear on the product, and the names of buttons, menus, etc. in the software on your PC/Mac, are indicated within square brackets ([ ]). (e.g. **[File]**, **[CUE]** button)
- Please note that the software screens and their specifications, as well as the external appearance and specifications of the hardware, are subject to change without notice.
- Please note that depending on the operating system version, web browser settings, etc. operation may differ from the ways described in this manual.
- Please note that the language on the screens of the software described in this manual may differ from the language on your screen.

---

---

# Contents

How to read this manual .....	2
<b>Before you start.....</b>	<b>5</b>
What's in the box .....	5
User guides.....	5
DJ software.....	6
<b>Part names and functions .....</b>	<b>9</b>
Top panel.....	9
Browse section .....	10
Deck section .....	16
Groove Circuit section .....	33
Mixer section.....	40
Effects section .....	45
Rear panel .....	51
Front panel.....	53
<b>Connections.....</b>	<b>54</b>
Connection examples .....	56
<b>rekordbox for Mac/Windows .....</b>	<b>59</b>
Installing rekordbox for Mac/Windows .....	59
Basic use .....	62
Advanced use .....	68
Changing the settings in rekordbox for Mac/Windows.....	92
<b>Serato DJ Pro.....</b>	<b>95</b>
Installing Serato DJ Pro .....	95
Basic use .....	98
Advanced use .....	105

<b>rekordbox for iOS/Android .....</b>	<b>126</b>
Installing rekordbox for iOS/Android .....	126
Basic use .....	128
Advanced use .....	134
Changing the settings in rekordbox for iOS/Android.....	151
<b>Changing the settings.....</b>	<b>154</b>
Launching Utilities mode.....	154
Utilities mode settings.....	155
<b>Additional information .....</b>	<b>159</b>
Troubleshooting .....	159
Specifications.....	168
Using the unit as a controller for other DJ applications .....	170
Trademarks and registered trademarks.....	171
Software license notice.....	172
Cautions on copyrights .....	174

---

---

# Before you start

---

---

## What's in the box

- USB cable
- Warranty (for some regions)<sup>1</sup>
- Quick Start Guide
- Precautions for Use
- Overlay sheet<sup>2</sup> × 2

<sup>1</sup> Only products in Europe.

Products in North America and Japan include warranty information in the Precautions for Use.

<sup>2</sup> Use for the Stems FX function.

➔ Using Stems FX (page 113)

---

---

## User guides

---

---

### rekordbox Introduction, Instruction Manual

Refer to the rekordbox Introduction to find out how to set up rekordbox for Mac/Windows, and see the rekordbox Instruction Manual to find out how to use rekordbox for Mac/Windows.

[rekordbox.com/manual](https://rekordbox.com/manual)

---

---

### Serato DJ Pro software manual

Visit the Serato DJ Pro website.

[serato.com/dj/pro/downloads](https://serato.com/dj/pro/downloads)

---

## DJ software

---

---

### rekordbox for Mac/Windows

- rekordbox for Mac/Windows is a complete DJ application you can use to manage your music and perform.
- Even if you don't have a paid subscription plan, you can use Performance mode by connecting this unit to your PC/Mac with rekordbox for Mac/Windows installed. This is called Hardware Unlock.
- You'll find details of the functions available via Hardware Unlock on **[Hardware Unlock]** under **[Support]** at [rekordbox.com](http://rekordbox.com).
- The rekordbox for Mac/Windows software is not included with the unit. Download the software from the URL below.  
[rekordbox.com](http://rekordbox.com)
- For information on the latest system requirements, compatibility, and supported operating systems of rekordbox for Mac/Windows, check **[System requirements]** under **[Support]** at [rekordbox.com](http://rekordbox.com).
- Operation isn't guaranteed on all PC/Mac models, even if the system requirements are met.
- Depending on power-saving settings and other conditions of the PC/Mac, the CPU and hard disk may not provide sufficient processing capabilities. For laptops in particular, make sure the PC/Mac is in the best condition to provide constant high-level performance when using rekordbox for Mac/Windows (for example by keeping the AC power connected).
- To use the internet, you need a separate contract with an internet service provider, which you may have to pay for.
- Operating system support always assumes you're using the latest point release for that version.

## Serato DJ Pro

Serato DJ Pro is DJ software from Serato Limited.

This unit unlocks the software, which you can download from the Serato website.

[serato.com/dj/pro/downloads](https://serato.com/dj/pro/downloads)

- For information on the latest system requirements, compatibility, and supported operating systems of Serato DJ Pro, visit the website below.

[serato.com/dj/pro/downloads](https://serato.com/dj/pro/downloads)

- Operation isn't guaranteed on all PC/Mac models, even if the system requirements are met.
- Depending on power-saving settings and other conditions of the PC/Mac, the CPU and hard disk may not provide sufficient processing capabilities. For laptops in particular, make sure the PC/Mac is in the best condition to provide constant high-level performance when using Serato DJ Pro (for example by keeping the AC power connected).

---

## rekordbox for iOS/Android

- rekordbox for iOS/Android is a mobile device application you can use to manage your music and perform.
- By connecting a mobile device running rekordbox for iOS/Android to the unit via a USB cable, you can perform with music files stored on the device or from a compatible streaming service.
- Install the latest version of rekordbox for iOS/Android from the App Store or Google Play (page 126).
- rekordbox for iOS can be used on iOS and iPad OS devices. rekordbox for Android can be used on Android devices. For information on the latest supported operating systems, check **[Mobile]** at rekordbox.com.
- Operation isn't guaranteed on all mobile devices listed on the above website.
- To power the unit, use a USB power adapter (not supplied) or mobile battery (not supplied).



---

---

# Part names and functions

---

---

## Top panel

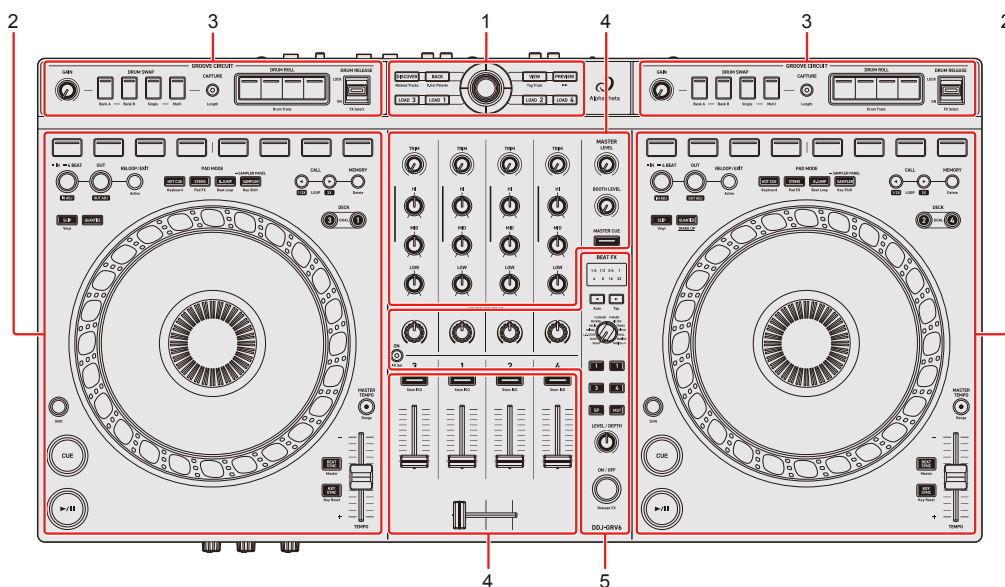

### 1 Browse section

Selects tracks and loads them to the decks.

### 2 Deck sections

Control each deck. There are knobs and buttons on the left side to control deck 1 and deck 3, and on the right side to control deck 2 and deck 4.

### 3 Groove Circuit section or Stem FX section (if the overlay is being used)

Controls the Groove Circuit (Drums Stem arrangement) function or the Stem FX function.

### 4 Mixer section

Controls the level adjustment for each channel, track mixing, etc.

### 5 Effects section

Controls the effects.

## Browse section

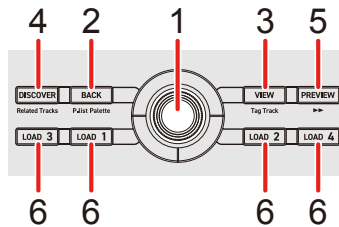

### ❖ Using rekordbox for Mac/Windows

#### 1 Smart rotary selector

Turn:

Moves the cursor in rekordbox.

**[Shift]** + turn:

Enlarges or shrinks the enlarged waveform in rekordbox.

Turn to the right to enlarge, or the left to shrink it.

Press:

If the cursor is pointed to a playlist, the cursor moves to the track list.

If the cursor is pointed to a folder, the folder opens.

- When the playlist palette is displayed, the cursor will also move to the track list when the cursor is on a playlist in the playlist palette.
- The tree view, track list, and playlist palette are displayed in the browse area of rekordbox. For details on each, read the rekordbox Instruction Manual.

Tilt forward or backward:

Moves the cursor to the up or down in the track list.

If you hold tilting the selector, the cursor moves continuously.

**[Shift]** + tilt forward or backward:

Moves the cursor to the top/bottom in the browse area.

# Part names and functions

Tilt to the right/left:

Moves the cursor to the right/left in the browse area.

If you hold tilting the selector, the cursor moves continuously.

**[Shift]** + tilt to the right/left:

Moves the cursor to the right/left end in the browse area.

## 2 BACK button

Press:

Moves the cursor between the tree view and track list each time you press the button.

- When the playlist palette is displayed, the cursor will move between the tree view, track list, and a playlist in the playlist palette.
- The tree view, track list, and playlist palette are displayed in the browse area of rekordbox. For details on each, read the rekordbox Instruction Manual.

**[Shift]** + press:

Displays/hides the playlist palette.

## 3 VIEW button

Press:

Shrinks the deck display and enlarges the browse area. Press the button again to return to the original display status.

**[Shift]** + press:

Adds or deletes the selected track to/from **[Tag List]**.

## 4 DISCOVER button

Press:

Moves the cursor into **[Track Suggestion]**.

- If the cursor is in **[Track Suggestion]**, it returns to the previous position.

**[Shift]** + press:

Moves the cursor into **[Related Tracks]** in **[Media Browser]**.

## 5 PREVIEW button

Press:

Plays/pauses the Preview Player of rekordbox.

Playback sound outputs from the **[⌂ (headphones)]** output terminal.

- To adjust the volume, set the **[Preferences]** window > **[Audio]** > **[Preview Volume]** on rekordbox.

**[Shift]** + press:

Moves the Preview Player's playback position forward 30 seconds.

## 6 LOAD buttons

Press:

Load the selected track to the respective deck.

Press twice:

Load the track from the deck that isn't playing onto the deck that is playing. If you do this while the track is playing, it plays from the same position (Instant Doubles).

## ❖ Using Serato DJ Pro

### 1 Smart rotary selector

Turn:

Moves the cursor up or down in the library or in the **[crates]** panel.

Press:

If the cursor is pointed to a library or **[crates]**, the cursor moves between the library and **[crates]** panels each time you press the button.

Tilt forward or backward:

Moves the cursor up or down in the library or in the **[crates]** panel.

# Part names and functions

Tilt to the left:

Moves the cursor between the library and **[crates]** panel each time you tilt the selector.

Tilt to the right:

If the cursor is pointed to a library or **[crates]**, the cursor moves between the library and **[crates]** panels each time you tilt the selector.

## 2 **BACK button**

Press:

Moves the cursor between the library and **[crates]** panel each time you press the button.

## 3 **VIEW button**

Press:

Changes the screen layout of Serato DJ Pro.

## 4 **DISCOVER button**

Press:

Changes the panel display each time you press the button.

## 5 **PREVIEW button**

Press:

Loads a track onto the **[PREPARE]** panel.

## 6 **LOAD buttons**

Press:

Load the selected track to the respective deck.

Press twice:

Load the track from the deck that isn't playing onto the deck that is playing. If you do this while the track is playing, it plays from the same position (Instant Doubles).

## ❖ Using rekordbox for iOS/Android

### 1 Smart rotary selector

Turn:

Moves the cursor in rekordbox.

Press:

Moves the cursor to the next level down.

Tilt forward or backward:

Up/Down pages in the browse screen.

**[Shift]** + tilt forward or upward:

Moves the cursor to the top/bottom in the browse screen.

Tilt to the left:

Moves the cursor to the next level up.

Tilt to the right:

Moves the cursor to the next level down.

### 2 BACK button

Press:

Moves the cursor to the next level up.

### 3 VIEW button

Press:

Changes the rekordbox display (Waveform/Jog).

### 4 DISCOVER button

Press:

Changes the library on the browse screen.

### 5 PREVIEW button

Press:

Changes the BPM panel on rekordbox.

## 6 LOAD buttons

Press:

Load the selected track to the respective deck.

- **[LOAD]** buttons for the deck 3 and 4 aren't be used.

Press twice:

Load the track from the deck that isn't playing onto the deck that is playing. If you do this while the track is playing, it plays from the same position (Instant Doubles).

## Deck section

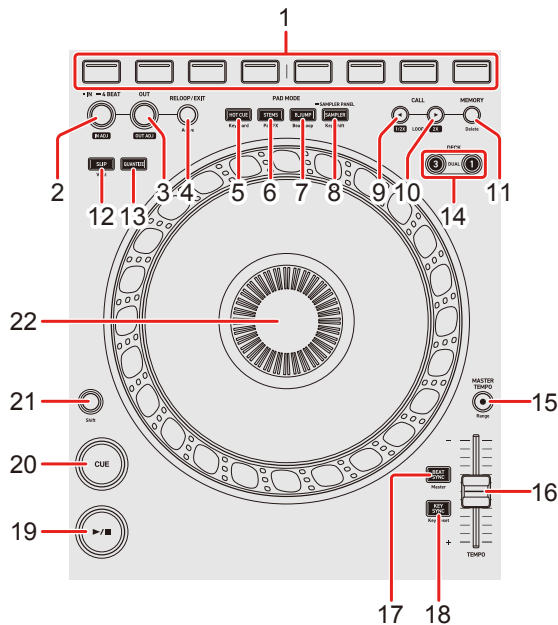

### ❖ Using rekordbox for Mac/Windows

#### 1 Performance Pads

Press:

You can use Performance Pads to trigger various features.

➔ Read more: Using the Performance Pads (page 70)

#### 2 IN button

Press:

Sets the loop in point.

Press (during loop playback):

Adjusts the loop in point using the jog wheel.

Hold:

Starts Auto Beat Loop of 4 beats.



## 3 OUT button

Press:

Sets the loop out point, and loop playback begins.

Press (during loop playback):

Adjusts the loop out point using the jog wheel.

## 4 RELOOP/EXIT button

Press:

Playback returns to the previously set loop in point and loop playback resumes.

Press (during loop playback):

Cancels loop playback.

**[Shift]** + press:

Switches the active/non-active status of the loop. (Active Loop)

- During playback, the loop nearest the playback position is set to active.
- When you call up the loop, the called-up loop is set to active or non-active.

## 5 HOT CUE mode button

Press:

Enters Hot Cue mode.

➞ Read more: Using Hot Cues (page 70)

**[Shift]** + press:

Enters Keyboard mode.

➞ Read more: Using Keyboard mode (page 75)

## 6 STEMS mode button

Press:

Enters Stems mode.

➞ Read more: Using Stems (page 72)

**[Shift]** + press:

Enters Pad FX mode.

➤ Read more: Using Pad FX (page 76)

## 7 **B.JUMP mode button**

Press:

Enters Beat Jump mode.

➤ Read more: Using Beat Jump (page 72)

**[Shift]** + press:

Enters Beat Loop mode.

➤ Read more: Using Beat Loop (page 77)

## 8 **SAMPLER mode button**

Press:

Enters Sampler mode.

➤ Read more: Using Sampler (page 73)

Hold:

Displays the SAMPLER panel.

**[Shift]** + press:

Enters Key Shift mode.

➤ Read more: Using Key Shift (page 78)

## 9 **CALL ◀ button**

Press:

Selects and calls up the cue point or loop point.

Press (during loop playback):

Halves the loop playback length.

## 10 **CALL ▶ button**

Press:

Selects and calls up the cue point or loop point.

# Part names and functions

Press (during loop playback):  
Doubles the loop playback length.

## 11 MEMORY button

Press:  
Saves the cue point or loop point.

**[Shift]** + press:  
Deletes the cue point or loop point.

## 12 SLIP button

Press:  
Turns Slip mode on/off.

**[Shift]** + press:  
Turns Vinyl mode on/off.

## 13 QUANTIZE button

Press:  
Turns the Quantize function on/off.

Press (during Power Management Off mode):  
Cancels Power Management Off mode.

- You can only do this on the right deck.

**[Shift]** + press:  
Hold the **[Shift]** button and tap the button to set the tempo of the respective deck in time with your tapping (Tap feature).

## 14 DECK button

Press:  
Switches the deck to be used.

# Part names and functions

Press the **[DECK 3]** button while holding the **[DECK 1]** button, or press the **[DECK 1]** button while holding the **[DECK 3]** button:

Turns Dual Deck mode on in the left deck.

Press the **[DECK 4]** button while holding the **[DECK 2]** button, or press the **[DECK 2]** button while holding the **[DECK 4]** button:

Turns Dual Deck mode on in the right deck.

## 15 MASTER TEMPO button

Press:

Turns the Master Tempo function on/off.

If the Master Tempo function is on, changing the playback speed with the **[TEMPO]** slider doesn't change the pitch.

**[Shift]** + press:

Switches the range of the **[TEMPO]** slider each time the button is pressed while holding the **[Shift]** button.

Switch between **[±6%]** → **[±10%]** → **[±16%]** → **[WIDE]** → **[±6%]**.

## 16 TEMPO slider

Adjusts the playing speed of the track.

## 17 BEAT SYNC button

Press:

Automatically synchronizes the tempo (BPM) and beatgrid with the deck set as the master.

Press (during Beat Sync):

Cancels Beat Sync.

**[Shift]** + press:

Sets the deck as the master.

## 18 KEY SYNC button

Press:

Changes the key of the track to match the other deck.

**[Shift]** + press:

Changes the key of the track that's playing to the original key.

## 19 ►/|| (play/pause) button

Press:

Plays/pauses a track.

## 20 CUE button

Press:

Sets, calls up, and plays from a cue point.

- Press the button when the track is paused to set the cue point.
- Press the button when the track is playing to return to the cue point and pause. (Back Cue)
- Press the button and hold it after the track returns to the cue point and playback will continue until you release the button. (Cue Point Sampler)

**[Shift]** + press:

Returns the playback position to the beginning of the track.

## 21 Shift button

Press another button while holding the **[Shift]** button to use a different feature assigned to the button.

## 22 Jog wheel

Turn the top when Vinyl mode is on:

Scratches the track.

Turn the outer section or turn the top when Vinyl mode is off:

Bends the pitch (Pitch Bend – slows down or speeds up the track).

# Part names and functions

**[Shift]** + turn the top:

Fast-forward or fast-reverse the track with extra speed in the direction the wheel is turned.

## ❖ Using Serato DJ Pro

### 1 Performance Pads

Press:

You can use Performance Pads to trigger various features.

➡ Read more: Using the Performance Pads (page 107)

### 2 IN button

Press:

Sets the loop in point.

Press (during loop playback):

Adjusts the loop in point using the jog wheel.

Hold:

Starts Auto Beat Loop of 4 beats.

### 3 OUT button

Press:

Sets the loop out point, and loop playback begins.

Press (during loop playback):

Adjusts the loop out point using the jog wheel.

### 4 RELOOP/EXIT button

Press:

Playback returns to the previously set loop in point and loop playback resumes.

Press (during loop playback):

Cancel loop playback.

**[Shift]** + press:

Switches the active/non-active status of the loop.

## 5 HOT CUE mode button

Press:

Enters Hot Cue mode.

➡ Read more: Using Hot Cues (page 107)

**[Shift]** + press:

Enters Pitch Play mode.

➡ Read more: Using Pitch Play (page 110)

## 6 STEMS mode button

Press:

Enters Stems mode.

➡ Read more: Using Stems (page 108)

**[Shift]** + press:

Enters Pad FX mode.

➡ Read more: Using Pad FX (page 110)

## 7 B.JUMP mode button

Press:

Enters Beat Jump mode.

➡ Read more: Using Beat Jump (page 108)

**[Shift]** + press:

Enters Auto Loop mode.

➡ Read more: Using Auto Loop (page 111)

## 8 SAMPLER mode button

Press:

Enters Sampler mode.

➡ Read more: Using Sampler (page 109)

Hold:

Displays the **[SAMPLER]** panel.

**[Shift]** + press:

Enters Key Shift mode.

➡ Read more: Using Key Shift (page 112)

## 9 **CALL ◀ button**

Press:

Selects the loop slot.

Press (during loop playback):

Halves the loop playback length.

## 10 **CALL ▶ button**

Press:

Selects the loop slot.

Press (during loop playback):

Doubles the loop playback length.

## 11 **MEMORY button**

Press:

Locks the loop slot.

**[Shift]** + press:

Deletes the loop slot.

## 12 **SLIP button**

Press:

Turns Slip mode on/off.

**[Shift]** + press:

Turns Vinyl mode on/off.



## 13 QUANTIZE button

Press:

Turns the Quantize function on/off.

Press (during Power Management Off mode):

Cancels Power Management Off mode.

- You can only do this on the right deck.

**[Shift]** + press:

Hold the **[Shift]** button and tap the button to set the tempo of the respective deck in time with your tapping (Tap feature).

## 14 DECK button

Press:

Switches the deck to be used.

Press the **[DECK 3]** button while holding the **[DECK 1]** button, or press the **[DECK 1]** button while holding the **[DECK 3]** button:

Turns Dual Deck mode on in the left deck.

Press the **[DECK 4]** button while holding the **[DECK 2]** button, or press the **[DECK 2]** button while holding the **[DECK 4]** button:

Turns Dual Deck mode on in the right deck.

## 15 MASTER TEMPO button

Press:

Turns the Key Lock function on/off.

If the Key Lock function is on, changing the playback speed with the **[TEMPO]** slider doesn't change the pitch.

**[Shift]** + press:

Switches the range of the **[TEMPO]** slider each time the button is pressed while holding the **[Shift]** button.

Switch between **[±8%]** → **[±16%]** → **[±50%]** → **[±100%]** → **[±8%]**.

## 16 TEMPO slider

Adjusts the playing speed of the track.

## 17 BEAT SYNC button

Press:

The tempo (BPM) and beatgrid of multiple decks are automatically synchronized.

**[Shift]** + press:

Cancel Sync mode.

## 18 KEY SYNC button

Key Sync and Key Reset are functions of Pitch 'n Time DJ.

- The Pitch 'n Time DJ expansion is not included with the Serato DJ Pro licence. To use this function, you'll need to buy and activate it first. Refer to the website below.

[serato.com/dj/pro/expansions/pitchntimedj](http://serato.com/dj/pro/expansions/pitchntimedj)

Press:

Changes the key of the track to match the other deck (Key Sync).

**[Shift]** + press:

Changes the key of the track on the deck that is playing to the original key (Key Reset).

## 19 ►/|| (play/pause) button

Press:

Plays/pauses a track.

**[Shift]** + press:

Returns to the temporary cue point and playback starts (Stutter).

## 20 CUE button

Press:

Sets, calls up, and plays from a cue point.

- Press the button when the track is paused to set the cue point.
- Press the button when the track is playing to return to the cue point and pause (Back Cue).
- Press the button and hold it after the track returns to the cue point and playback will continue until you release the button (Cue Point Sampler).

**[Shift]** + press:

Returns the playback position to the beginning of the track.

## 21 Shift button

Press another button while holding the **[Shift]** button to use a different feature assigned to the button.

## 22 Jog wheel

Turn the top when Vinyl mode is on:

Scratches the track.

Turn the outer section or turn the top when Vinyl mode is off:

Bends the pitch (Pitch Bend – slows down or speeds up the track).

**[Shift]** + turn the top:

Fast-forward or fast-reverse the track with extra speed in the direction you turn the jog wheel.

## ❖ Using rekordbox for iOS/Android

### 1 Performance Pads

Press:

You can use Performance Pads to trigger various features.

➡ Read more: Using the Performance Pads (page 136)

## 2 IN button

Press:

Sets the loop in point.

Press (during loop playback):

Adjusts the loop in point using the jog wheel.

Hold:

Starts Auto Beat Loop of 4 beats.

## 3 OUT button

Press:

Sets the loop out point, and loop playback begins.

Press (during loop playback):

Adjusts the loop out point using the jog wheel.

## 4 RELOOP/EXIT button

Press:

Playback returns to the previously set loop in point and loop playback resumes.

Press (during loop playback):

Cancels loop playback.

**[Shift]** + press:

Switches the active/non-active status of the loop. (Active Loop)

- During playback, the loop nearest the playback position is set to active.
- When you call up the loop, the called-up loop is set to active or non-active.

## 5 HOT CUE mode button

Press:

Enters Hot Cue mode.

➡ Read more: Using Hot Cues (page 136)

**[Shift]** + press:

Enters Keyboard mode.

➡ Read more: Using Keyboard mode (page 141)

## 6 **STEMS mode button**

Press:

Enters Pad FX 1 mode.

➡ Read more: Using Pad FX (page 138)

**[Shift]** + press:

Enters Pad FX 2 mode.

➡ Read more: Using Pad FX (page 138)

## 7 **B.JUMP mode button**

Press:

Enters Beat Jump mode.

➡ Read more: Using Beat Jump (page 139)

**[Shift]** + press:

Enters Beat Loop mode.

➡ Read more: Using Beat Loop (page 142)

## 8 **SAMPLER mode button**

Press:

Enters Sampler mode.

➡ Read more: Using Sampler (page 140)

**[Shift]** + press:

Enters Key Shift mode.

➡ Read more: Using Key Shift (page 143)

## 9 **CALL ◀ button**

Press:

Selects and calls up the cue point or loop point.

# Part names and functions

Press (during loop playback):  
Halves the loop playback length.

## 10 CALL ► button

Press:  
Selects and calls up the cue point or loop point.

Press (during loop playback):  
Doubles the loop playback length.

## 11 MEMORY button

Press:  
Saves the cue point or loop point.

**[Shift]** + press:  
Deletes the cue point or loop point.

## 12 SLIP button

Press:  
Turns Slip mode on/off.

**[Shift]** + press:  
Turns Vinyl mode on/off.

## 13 QUANTIZE button

Press:  
Turns the Quantize function on/off.

Press (during Power Management Off mode):  
Cancels Power Management Off mode.

- You can only do this on the right deck.

**[Shift]** + press:  
Hold the **[Shift]** button and tap the button to set the tempo of the respective deck in time with your tapping (Tap feature).

## 14 DECK button

This button isn't used when using rekordbox for iOS/Android.

## 15 MASTER TEMPO button

Press:

Turns the Master Tempo function on/off.

If the Master Tempo function is on, changing the playback speed with the **[TEMPO]** slider doesn't change the pitch.

**[Shift]** + press:

Switches the range of the **[TEMPO]** slider each time the button is pressed while holding the **[Shift]** button.

Switch between **[±6%]** → **[±10%]** → **[±16%]** → **[WIDE]** → **[±6%]**.

## 16 TEMPO slider

Adjusts the playing speed of the track.

## 17 BEAT SYNC button

Press:

Automatically synchronizes the tempo (BPM) and beatgrid with the deck set as the master.

Press (during Beat Sync):

Cancels Beat Sync.

**[Shift]** + press:

Sets the deck as the master.

## 18 KEY SYNC button

Press:

Changes the key of the track to match the other deck.

**[Shift]** + press:

Changes the key of the track that's playing to the original key.

## 19 ►/|| (play/pause) button

Press:

Plays/pauses a track.

## 20 CUE button

Press:

Sets, calls up, and plays from a cue point.

- Press the button when the track is paused to set the cue point.
- Press the button when the track is playing to return to the cue point and pause. (Back Cue)
- Press the button and hold it after the track returns to the cue point and playback will continue until you release the button. (Cue Point Sampler)

**[Shift]** + press:

Returns the playback position to the beginning of the track.

## 21 Shift button

Press another button while holding the **[Shift]** button to use a different feature assigned to the button.

## 22 Jog wheel

Turn the top when Vinyl mode is on:

Scratches the track.

Turn the outer section or turn the top when Vinyl mode is off:

Bends the pitch (Pitch Bend – slows down or speeds up the track).

**[Shift]** + turn the top:

Fast-forward or fast-reverse the track with extra speed in the direction the wheel is turned.



## Groove Circuit section

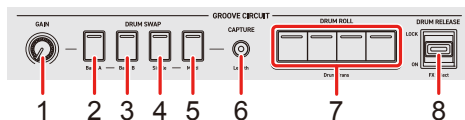

### ❖ Using rekordbox for Mac/Windows

#### 1 GAIN knob

Turn:

Adjusts the volume of Drum Swap 1 to 4.

#### 2 DRUM SWAP 1 button

Press:

Plays/pause the drum loop sound source set to this button.

Press (when Drum Capture is turned on):

Sets the drum loop sound source cut out with the **[CAPTURE]** button to this button.

**[Shift]** + press:

Switches the bank of the drum loop sound source to Drum Loop Bank A.

#### 3 DRUM SWAP 2 button

Press:

Plays/pause the drum loop sound source set to this button.

Press (when Drum Capture is turned on):

Sets the drum loop sound source cut out with the **[CAPTURE]** button to this button.

**[Shift]** + press:

Switches the bank of the drum loop sound source to Drum Loop Bank B.

## 4 DRUM SWAP 3 button

Press:

Plays/pause the drum loop sound source set to this button.

Press (when Drum Capture is turned on):

Sets the drum loop sound source cut out with the **[CAPTURE]** button to this button.

**[Shift]** + press:

Switches the playback mode of the drum loop sound source to Drum Swap Single Mode.

## 5 DRUM SWAP 4 button

Press:

Plays/pause the drum loop sound source set to this button.

Press (when Drum Capture is turned on):

Sets the drum loop sound source cut out with the **[CAPTURE]** button to this button.

**[Shift]** + press:

Switches the playback mode of the drum loop sound source to Drum Swap Multi Mode.

## 6 CAPTURE button

Press:

Selects a range of the Drums Stem sound with the specific number of beats from the position where the button is pressed.

If you press the **[DRUM SWAP]** button while Drum Capture is on, the selected Drums Stem sound will be loaded.

**[Shift]** + press:

Changes the captured range each time the button is pressed while holding the **[Shift]** button.

## 7 DRUM ROLL buttons

Hold:

Applies Roll effect to the drum loop sound source or Drums Stem.

**[Shift]** + hold:

Applies Trans effect to the drum loop sound source or Drums Stem.

## 8 DRUM RELEASE lever

Tilt forward or backward and hold it:

Applies Drum Release FX to the drum loop sound source or Drums Stem.

When you return the lever to the center position, the effect is canceled.

**[Shift]** + tilt toward you:

Switches the Drum Release FX type each time the lever is tilted while holding the **[Shift]** button.

## ❖ Using Serato DJ Pro

When the DDJ-GRV6 is used with Serato DJ Pro, only the Stem FX feature can be used for this set of control functions. Use the Overlay sheet supplied when using the DDJ-GRV6 with Serato DJ Pro.

## 1 LEVEL/DEPTH (GAIN) knob

Turn:

Adjusts the Level/Depth of the effects (Echo Out, Roll Out, Braker, and Delay) that can be applied to the selected Stem(s) via the **[FX (DRUM RELEASE)]** lever.

## 2 VOCAL (DRUM SWAP 1) button

Press:

ON to arm the Vocal Stem for Stem FX

OFF to disarm the Vocal Stem for Stem FX

**[Shift]** + press:

Selects Echo Out for the FX assigned to the **[FX (DRUM RELEASE)]** lever.

# Part names and functions

## 3 MELODY (DRUM SWAP 2) button

Press:

ON to arm the Melody Stem for Stem FX

OFF to disarm the Melody Stem for Stem FX

**[Shift]** + press:

Selects Roll Out for the FX assigned to the **[FX (DRUM RELEASE)]** lever.

## 4 BASS (DRUM SWAP 3) button

Press:

ON to arm the Bass Stem for Stem FX

OFF to disarm the Bass Stem for Stem FX

**[Shift]** + press:

Selects Braker for the FX assigned to the **[FX (DRUM RELEASE)]** lever.

## 5 DRUMS (DRUM SWAP 4) button

Press:

ON to arm the Drum Stem for Stem FX

OFF to disarm the Drum Stem for Stem FX

**[Shift]** + press:

Selects Delay for the FX assigned to the **[FX (DRUM RELEASE)]** lever.

## 6 1/2 BEAT (CAPTURE) button

Press:

ON to apply 1/2 beat value of the effect (Echo Out, Roll Out, Braker, and Delay) applied to the selected Stem(s) via the **[FX (DRUM RELEASE)]** lever

OFF to apply 1 beat value of the effect (Echo Out, Roll Out, Braker, and Delay) applied to the selected Stem(s) via the **[FX (DRUM RELEASE)]** lever

# Part names and functions

**[Shift]** + press:

Latches the **[STEMS ROLL (DRUM ROLL)]** buttons ON. Toggling **[Shift]** + **[1/2 BEAT (CAPTURE)]** button again turns off the latch function for the **[STEMS ROLL (DRUM ROLL)]** buttons. The Latch function allows you to let go of the **[STEMS ROLL (DRUM ROLL)]** buttons and the FX will still be applied to the selected Stem(s).

## 7 **STEMS ROLL (DRUM ROLL) buttons**

Press:

Applies 1/8, 1/4, 1/2 or 1 beat Roll to the selected Stem(s).

**[Shift]** + press:

Applies Trans effect of 1/8, 1/4, 1/2 or 1 beat to the selected Stem(s).

If Latch is OFF, the **[STEMS ROLL (DRUM ROLL)]** buttons must be held to apply the effect to the selected Stem(s). If Latch is ON, the button does not need to be held to apply the Roll effect.

## 8 **FX (DRUM RELEASE) lever**

Tilt toward you:

Apply the assigned effect (either Echo Out, Roll Out, Braker or Delay) to the armed Stem(s) momentarily.

Tilt away from you:

LOCK ON the assigned effect (either Echo Out, Roll Out, Braker or Delay) to the armed Stem(s).

If the **[FX (DRUM RELEASE)]** lever is in the center position, the FX assigned to the **[FX (DRUM RELEASE)]** lever is OFF.

- If the **[LEVEL/DEPTH (GAIN)]** knob is at the 0 position (all the way left) the FX assigned to the **[FX (DRUM RELEASE)]** lever will not be heard.

## ❖ Using rekordbox for iOS/Android

### 1 GAIN knob

Turn:

Adjusts the volume of the sampler sound.

### 2 DRUM SWAP 1 button

Press:

Plays the sampler slot 1 in the left deck or the sampler slot 9 in the right deck. If the sampler slot is changed with the **[CAPTURE]** button, plays the sampler slot 5 in the left deck or the sampler slot 13 in the right deck.

**[Shift]** + press:

Stops the playback of the sampler slot.

### 3 DRUM SWAP 2 button

Press:

Plays the sampler slot 2 in the left deck or the sampler slot 10 in the right deck. If the sampler slot is changed with the **[CAPTURE]** button, plays the sampler slot 6 in the left deck or the sampler slot 14 in the right deck.

**[Shift]** + press:

Stops the playback of the sampler slot.

### 4 DRUM SWAP 3 button

Press:

Plays the sampler slot 3 in the left deck or the sampler slot 11 in the right deck. If the sampler slot is changed with the **[CAPTURE]** button, plays the sampler slot 7 in the left deck or the sampler slot 15 in the right deck.

**[Shift]** + press:

Stops the playback of the sampler slot.

## 5 DRUM SWAP 4 button

Press:

Plays the sampler slot 4 in the left deck or the sampler slot 12 in the right deck.  
If the sampler slot is changed with the **[CAPTURE]** button, plays the sampler slot 8 in the left deck or the sampler slot 16 in the right deck.

**[Shift]** + press:

Stops the playback of the sampler slot.

## 6 CAPTURE button

Press:

Switches the sampler slot operated with the **[DRUM SWAP]** button.  
In the left deck, slot 1 through 4 switches to slot 5 through 8.  
In the right deck, slot 9 through 12 to slot 13 through 16.

## 7 DRUM ROLL buttons

Hold:

Applies Roll effect to the sound of the deck.

**[Shift]** + hold:

Applies Trans effect to the sound of the deck.

## 8 DRUM RELEASE lever

Tilt forward or backward and hold it:

Applies Vinyl Brake effect to the sound of the deck.

When you return the lever to the center position, the effect is canceled.

**[Shift]** + tilt forward or backward and hold it:

Applies Release Echo effect to the sound of the deck.

When you return the lever to the center position, the effect is canceled.

## Mixer section

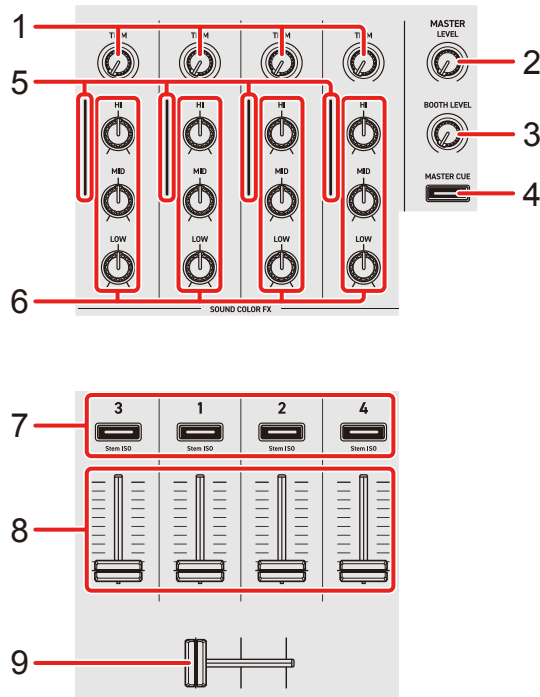

### ❖ Using rekordbox for Mac/Windows

#### 1 TRIM knobs

Adjust the volume of each channel's sound.

#### 2 MASTER LEVEL knob

Adjusts the volume of the master output sound.

#### 3 BOOTH LEVEL knob

Adjusts the volume of the sound output from the **[BOOTH]** output terminals.

#### 4 MASTER CUE button

Press:

Plays the master sound through your headphones.



## 5 Channel level indicators

Indicate the volume of the sound of the respective channels before it passes through the channel faders.

## 6 EQ (HI, MID, LOW) knobs

For EQ mode, increase or decrease the relevant frequency for each channel. For Stem ISO mode, adjust the volume of each Stem.

Adjusts the volume of the Vocal Stem with the EQ **[HI]** knob, the Inst Stem with the EQ **[MID]** knob, and the Drums Stem with the EQ **[LOW]** knob.

- You can change the Stem to be adjusted by setting the **[Preferences]** > **[Extensions]** > **[STEMS]** > **[Layout]** in rekordbox.
- ➡ For information on changing the mode, see: 7 Headphones CUE buttons (channel)

## 7 Headphones CUE buttons (channel)

Press:

Play the sound of the relevant channel through your headphones.

**[Shift]** + press:

Switches between EQ mode and Stem ISO mode for the EQ knobs on each channel.

- ➡ See: 6 EQ (HI, MID, LOW) knobs

## 8 Channel faders

Slide:

Adjust the volume of the sound for each channel.

**[Shift]** + slide:

Triggers Fader Start.

## 9 Crossfader

Slide:

Adjusts the sound balance between the left and right channels depending on the crossfader curve setting.

# Part names and functions

**[Shift]** + slide:

Triggers Fader Start.

## ❖ Using Serato DJ Pro

### 1 TRIM knobs

Adjust the volume of each channel's sound.

### 2 MASTER LEVEL knob

Adjusts the volume of the master output sound.

### 3 BOOTH LEVEL knob

Adjusts the volume of the sound output from the **[BOOTH]** output terminals.

### 4 MASTER CUE button

Press:

Plays the master sound through your headphones.

### 5 Channel level indicators

Indicate the volume of the sound of the respective channels before it passes through the channel faders.

### 6 EQ (HI, MID, LOW) knobs

For EQ mode, increase or decrease the relevant frequency for each channel.

For Stems Level mode, adjust the volume of each Stem.

Adjusts the volume of the Vocal Stem with the EQ **[HI]** knob, the Bass and Melody Stems with the EQ **[MID]** knob, and the Drums Stem with the EQ **[LOW]** knob.

➡ For information on changing the mode, see: 7 Headphones CUE buttons (channel)

### 7 Headphones CUE buttons (channel)

Press:

Play the sound of the relevant channel through your headphones.

# Part names and functions

**[Shift]** + press:

Switches between EQ mode and Stems Level mode for the EQ knobs on each channel.

➡ See: 6 EQ (HI, MID, LOW) knobs

## 8 Channel faders

Slide:

Adjust the volume of the sound for each channel.

**[Shift]** + slide:

Triggers Fader Start.

## 9 Crossfader

Slide:

Adjusts the sound balance between the left and right channels depending on the crossfader curve setting.

**[Shift]** + slide:

Triggers Fader Start.

### ❖ Using rekordbox for iOS/Android

- For rekordbox for iOS/Android, only controls for channel 1 and 2 can be used.

Controls for channel 3 and 4 cannot be used.

### 1 TRIM knobs

Adjust the volume of each channel's sound.

### 2 MASTER LEVEL knob

Adjusts the volume of the master output sound.

### 3 BOOTH LEVEL knob

Adjusts the volume of the sound output from the **[BOOTH]** output terminals.

# Part names and functions

## 4 MASTER CUE button

Press:

Plays the master sound through your headphones.

## 5 Channel level indicators

Indicate the volume of the sound of the respective channels before it passes through the channel faders.

## 6 EQ (HI, MID, LOW) knobs

Boost or reduce the relevant frequency for the selected channel.

## 7 Headphones CUE buttons (channel)

Press:

Play the sound of the relevant channel through your headphones.

## 8 Channel faders

Slide:

Adjust the volume of the sound for each channel.

**[Shift]** + slide:

Triggers Fader Start.

## 9 Crossfader

Slide:

Adjusts the sound balance between the left and right channels depending on the crossfader curve setting.

**[Shift]** + slide:

Triggers Fader Start.

## Effects section

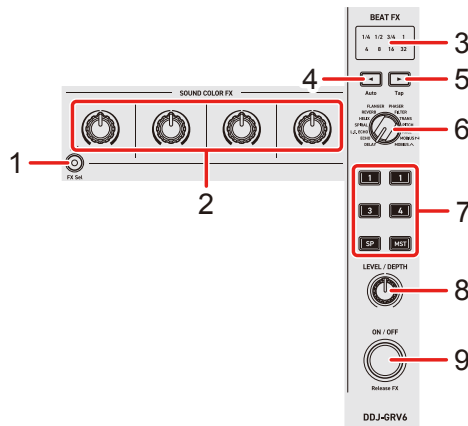

### ❖ Using rekordbox for Mac/Windows

#### 1 SOUND COLOR FX ON/OFF button

Press:

Turn Sound Color FX on/off.

**[Shift]** + press:

Switches the Sound Color FX type each time the button is pressed while holding the **[Shift]** button.

#### 2 SOUND COLOR FX knobs

When the **[SOUND COLOR FX ON/OFF]** button is off:

The sound is unchanged.

When the **[SOUND COLOR FX ON/OFF]** button is on:

Apply Sound Color FX to each channel.

When a knob is set to the center position, the sound is unchanged.

#### 3 BEAT FX beat indicators

Lights up for the selected beat.

When the beat outside the range is selected, the indicator flashes.

## 4 **BEAT ◀ button**

Press:

Decreases the number of beats for synchronizing the Beat FX sound each time the button is pressed.

**[Shift]** + press:

Sets the Beat FX Tempo mode to BPM Auto mode. The track's BPM is used as the basis for the Beat FX tempo.

## 5 **BEAT ▶ button**

Press:

Increases the number of beats for synchronizing the Beat FX sound each time the button is pressed.

**[Shift]** + press:

Sets the Beat FX Tempo mode to BPM Tap mode. The BPM used as the basis for Beat FX is set in time with your tapping of the button.

## 6 **BEAT FX SELECT knob**

Changes the Beat FX.

## 7 **BEAT FX CH SELECT button**

Press:

Changes the channel that Beat FX will be applied to.

## 8 **BEAT FX LEVEL/DEPTH knob**

Adjusts the parameter of Beat FX.

## 9 **BEAT FX ON/OFF button**

Press:

Turns Beat FX on/off.

**[Shift]** + press:

Turns Release FX on.

## ❖ Using Serato DJ Pro

### 1 **SOUND COLOR FX ON/OFF button**

Press:

Turn the selected channel effect on/off.

**[Shift]** + press:

Changes the selected channel effect (FILTER, DUB ECHO, REVERB, NOISE) assigned to the **[SOUND COLOR FX]** knobs.

### 2 **SOUND COLOR FX knobs**

When the **[SOUND COLOR FX ON/OFF]** button is off:

The sound is unchanged.

When the **[SOUND COLOR FX ON/OFF]** button is on:

Apply the selected channel effect to each channel.

When a knob is set to the center position, the sound is unchanged.

### 3 **BEAT FX beat indicators**

Lights up for the selected beat.

When the beat outside the range is selected, the indicator flashes.

### 4 **BEAT ◀ button**

Press:

Decreases the number of beats for synchronizing the effect sound each time the button is pressed.

**[Shift]** + press:

Sets the effect Tempo mode to BPM Auto mode. The track's BPM is used as the basis for the effect tempo.

### 5 **BEAT ▶ button**

Press:

Increases the number of beats for synchronizing the effect sound each time the button is pressed.

# Part names and functions

**[Shift]** + press:

Sets the effect Tempo mode to BPM Tap mode. The BPM used as the basis for effect is set in time with your tapping of the button.

## 6 **BEAT FX SELECT knob**

Changes the effect.

## 7 **BEAT FX CH SELECT button**

Press:

Changes the channel that the effect will be applied to.

## 8 **BEAT FX LEVEL/DEPTH knob**

Adjusts the depth parameter of effect.

## 9 **BEAT FX ON/OFF button**

Press:

Turns the effect on/off.

## ❖ **Using rekordbox for iOS/Android**

### 1 **SOUND COLOR FX ON/OFF button**

Press:

Turn Sound Color FX on/off.

**[Shift]** + press:

Switches the Sound Color FX type each time the button is pressed while holding the **[Shift]** button.

### 2 **SOUND COLOR FX knobs**

When the **[SOUND COLOR FX ON/OFF]** button is off:

The sound is unchanged.

When the **[SOUND COLOR FX ON/OFF]** button is on:

Apply Sound Color FX to each channel.

When a knob is set to the center position, the sound is unchanged.



## 3 BEAT FX beat indicators

Lights up for the selected beat.

When the beat outside the range is selected, the indicator flashes.

## 4 BEAT ◀ button

Press:

Decreases the number of beats for synchronizing the Beat FX sound each time the button is pressed.

[Shift] + press:

Sets the Beat FX Tempo mode to BPM Auto mode. The track's BPM is used as the basis for the Beat FX tempo.

## 5 BEAT ▶ button

Press:

Increases the number of beats for synchronizing the Beat FX sound each time the button is pressed.

[Shift] + press:

Sets the Beat FX Tempo mode to BPM Tap mode. The BPM used as the basis for Beat FX is set in time with your tapping of the button.

## 6 BEAT FX SELECT knob

Changes the Beat FX.

## 7 BEAT FX CH SELECT button

Press:

Changes the channel that the Beat FX will be applied to.

- The channel 3, channel 4, and SP cannot be selected.

## 8 BEAT FX LEVEL/DEPTH knob

Adjusts the parameter of Beat FX.

## 9 BEAT FX ON/OFF button

Press:

Turns Beat FX on/off.

**[Shift]** + press:

Turns Release FX on.

## Rear panel

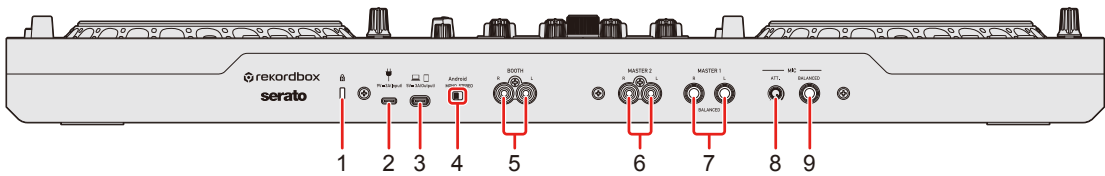

### 1 Kensington security slot

Connection for a cable lock for security.

### 2 USB port (for power supply)

Connection for a USB power adapter (not supplied) or mobile battery (not supplied).

- Use a product supported with USB Power Delivery.
- Use a USB Type-C cable.
- Use a USB cable certified to the appropriate standard.
- A USB hub cannot be used.

### 3 USB port (for device connection)

Connection for a PC/Mac/iOS/Android device.

- Be sure to use the USB cable specified below.
  - To connect to a USB Type-C port: use the USB cable supplied with the unit
  - To connect to a USB Type-A port: use a USB cable certified to the appropriate standard with a length of 3 m or less
  - To connect to a device with a Lightning terminal: use an Apple certified cable with a length of 3 m or less
- When using a USB hub, be sure it's a product recommended by the manufacturer of your PC/Mac. We don't guarantee the operation of all USB hubs.

### 4 Android MONO/STEREO switch

When connecting to an Android device, select the audio output format.

- After selecting [**STEREO**], the output sound may not be normal. In that case, select [**MONO**].
- [**MONO**]: Sound plays in mono (Default).
- [**STEREO**]: Sound plays in stereo.

## 5 **BOOTH output terminals (RCA pin jack type)**

Outputs for a booth monitor.

- Compatible with RCA pin jack-type unbalanced outputs.

## 6 **MASTER 2 output terminals (RCA pin jack type)**

Connection for analog input terminals of a power amplifier, etc.

- Compatible with RCA pin jack-type unbalanced outputs.

## 7 **MASTER 1 output terminals (1/4" / 6.35 mm, TRS)**

Connection for analog input terminals of a power amplifier, etc.

- Be sure to use these terminals as balanced outputs. If you connect them to an unbalanced input, sound quality may be lowered or unwanted noise may occur.

## 8 **MIC ATT. (Attenuator) knob**

Adjusts the volume of input sound from the **[MIC]** input terminal.

- Depending on the microphone, the gain of microphone sound differs. Use this knob to adjust the volume for your microphone before using it. While DJing, use the **[MIC LEVEL]** knob on the front panel to adjust the microphone volume.

## 9 **MIC input terminal (1/4" / 6.35 mm, TRS)**

Connection for a microphone.

- Only a phone plug (1/4") can be used.

## Front panel

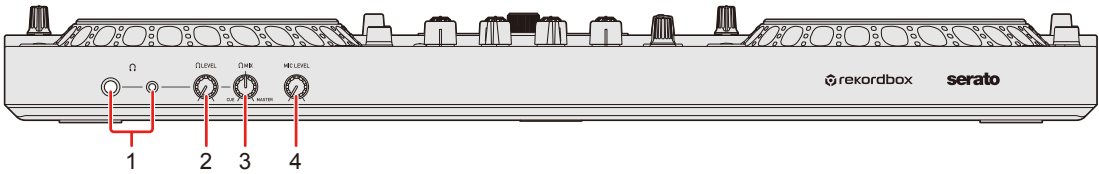

### 1 (headphones) output terminals

Connection for your headphones.

1/4" stereo jack and 3.5-mm stereo mini jack can be used with the unit.

- Only use headphones with 32  $\Omega$  or more impedance. Headphones with impedance lower than 32  $\Omega$  won't work with the unit.

### 2 (headphones) LEVEL knob

Adjusts the volume of the headphones sound.

### 3 (headphones) MIX knob

Adjusts the monitor volume balance between sounds from the channels which have the headphones **[CUE]** button pressed, and the master channel.

### 4 MIC LEVEL knob

Adjusts the volume of input sound from the **[MIC]** input terminal.

---

---

# Connections

- Be sure to disconnect the USB cable before connecting different devices or changing connections.  
Refer to the instruction manuals for devices to be connected.
- For connection to PC/Mac or a mobile device, be sure to use the USB cable specified below.
  - To connect to a device with a USB Type-C port: use the USB cable supplied with the unit
  - To connect to a device with a USB Type-A port: use a USB cable certified to the appropriate standard with a length of 3 m or less
  - To connect to a device with a Lightning terminal: use an Apple certified cable with a length of 3 m or less
- When using a USB hub, be sure it's a product recommended by the manufacturer of your PC/Mac. We don't guarantee the operation of all USB hubs.
- When connecting to a PC/Mac with a USB Type-C port, you can use the unit with a single connection to your computer (USB bus power). This unit can't be used with USB bus power in the following situations:
  - The power supply capacity of the USB port on your PC/Mac is too low.
  - Your PC/Mac is connected with other USB devices.
  - The impedance of the connected headphones is lower than 32  $\Omega$ .
  - A mono-jack plug is connected to the headphones output terminal.
- When connecting to a PC/Mac with a USB Type-A port, connect a USB power adapter or mobile battery to the USB port (for power supply) of the unit.
- When using the unit with a mobile device, use a USB power adapter or mobile battery to power the unit.

- When using the unit with a USB power adapter or mobile battery connected to the USB port (for power supply), make sure it has a maximum voltage of 24V or less and DC 9V 3A.  
Use a USB cable certified to the appropriate standard.  
Use a mobile battery without a power-saving function.
- When not using the microphone, turn the **[MIC LEVEL]** knob to the minimum level.

## Connection examples

### Connecting input / output terminals

#### Rear panel

##### ❖ For PC/Mac

- (1) PC/Mac
- (2) Powered speakers, power amplifier, etc.
- (3) Powered speakers, power amplifier (for booth monitor), etc.
- (4) Microphone

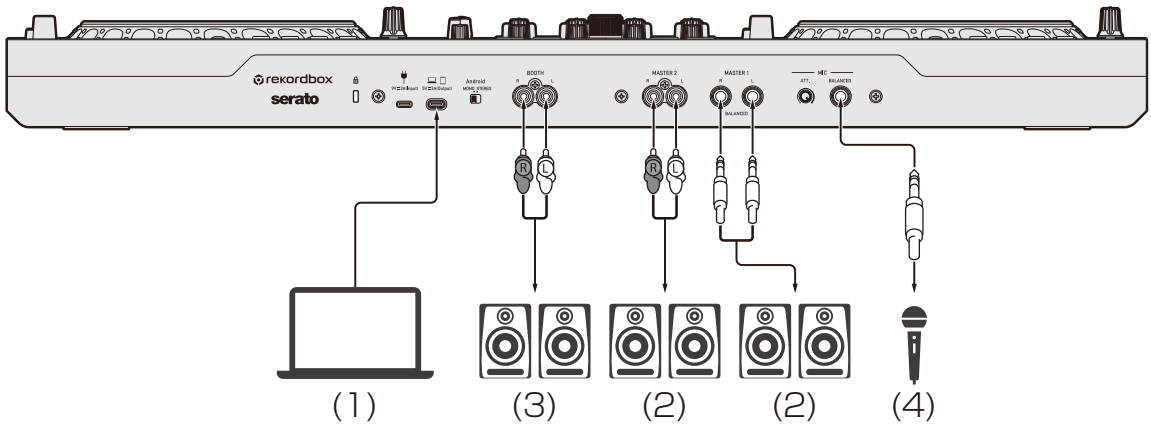

When connecting to a device with the USB-A port, connect a USB power adapter or mobile battery to the USB port (for power supply) of the unit.

- (5) USB power adapter or mobile battery

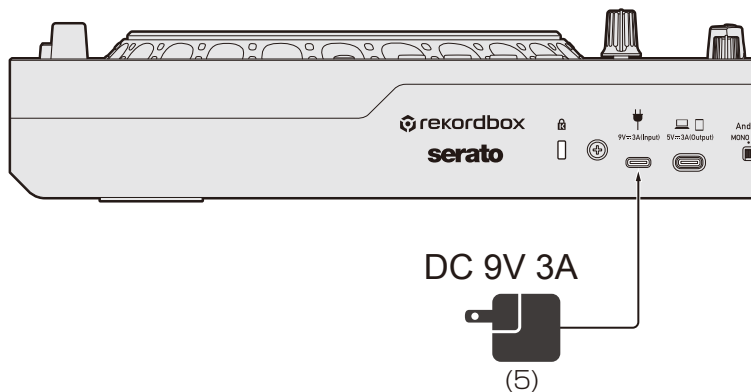



## ❖ For a mobile device

- (1) USB power adapter, mobile battery
- (2) Mobile device
- (3) Powered speakers, power amplifier, etc.
- (4) Powered speakers, power amplifier (for booth monitor), etc.
- (5) Microphone

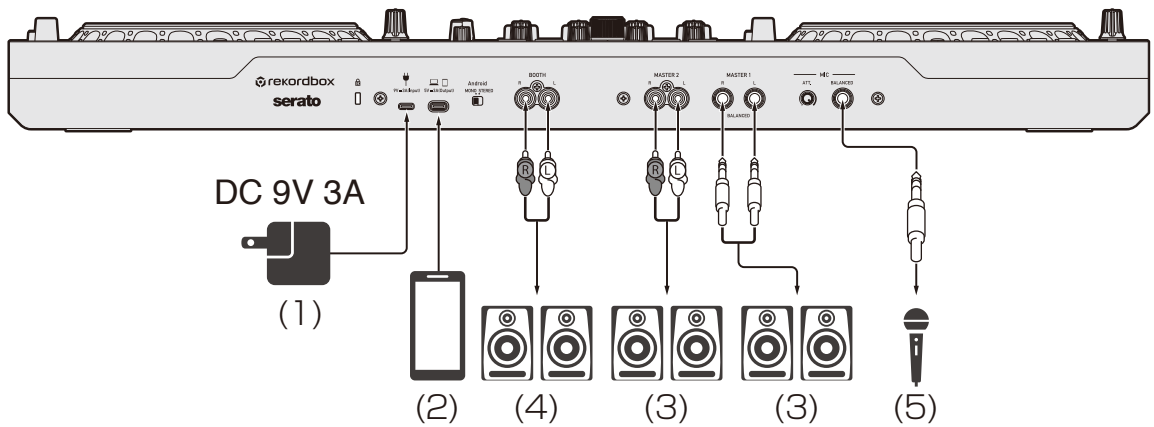

## Front panel

- (1) Headphones

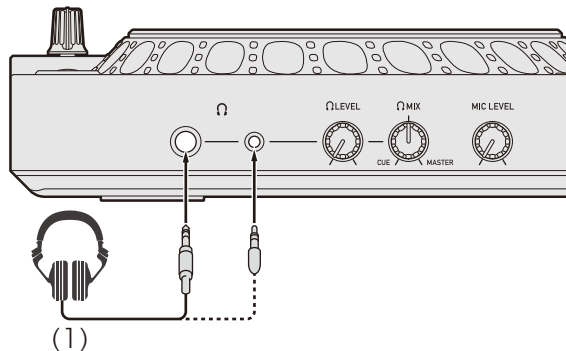

---

## Connecting

- 1 Connect your headphones to one of the [ (headphones)] output terminals on the unit's front panel.
- 2 Connect an output device such as a power amplifier to the **[MASTER 1]** output terminals or **[MASTER 2]** output terminals.
  - To output the sound from the **[BOOTH]** output terminals, connect a device to use as a booth monitor.
- 3 Connect your PC/Mac or mobile device to the USB port (for device connection) via a USB cable.
- 4 Turn on your PC/Mac or mobile device.
- 5 When using with a mobile device, connect a USB power adapter or mobile battery to the USB port (for power supply).
- 6 Turn on the devices connected to the terminals (powered speakers, microphone, etc.).

---

---

# rekordbox for Mac/Windows

---

---

## Installing rekordbox for Mac/Windows

---

### Getting started with rekordbox for Mac/Windows

If you're using rekordbox for Mac/Windows for the first time, download the latest version from rekordbox.com and install it in the following way. If you already have rekordbox for Mac/Windows installed, update to the latest version using the Update Manager which you'll see when you start rekordbox for Mac/Windows.

- You are responsible for preparing your PC/Mac, network devices, and other elements needed to connect to the internet.

---

### Installing rekordbox for Mac/Windows

Procedures may differ depending on the operating system (OS) of your PC/Mac.

#### ❖ Installing (Mac)

**Do not connect the unit to your Mac until installation is complete.**

- Close all programs on your Mac.
  - 1 Unzip the downloaded rekordbox for Mac/Windows software file.
  - 2 Double-click the unzipped software file to launch the installer.

# rekordbox for Mac/Windows

- 3 Read the terms of the License Agreement carefully and if you agree to them, click **[Agree]**.

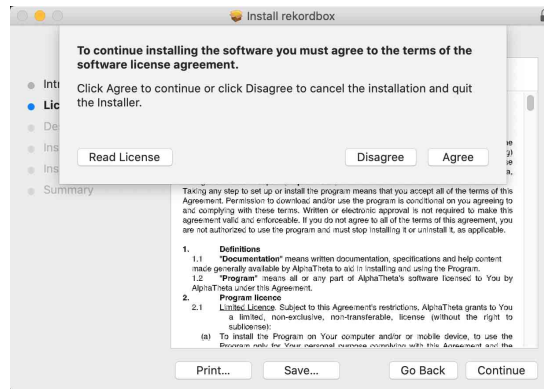

- If you do not agree to the contents of the License Agreement, click **[Disagree]** to cancel the installation.

- 4 When the screen for completing the installation appears, click **[Close]** to end the installation.

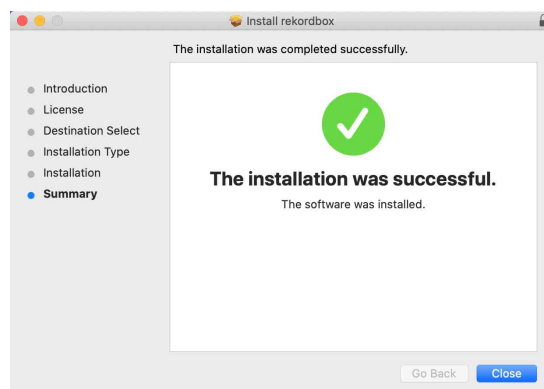

## ❖ Installing (Windows)

**Do not connect the unit to your PC until installation is complete.**

- Log into your PC as an administrator before starting the installation.
- Close all programs on your PC.

- 1 Unzip the downloaded rekordbox for Mac/Windows software file.
- 2 Double-click the unzipped software file to launch the installer.

# rekordbox for Mac/Windows

- 3 Read the terms of the License Agreement carefully and if you agree to them, select **[Agree]**, then click **[Next]**.

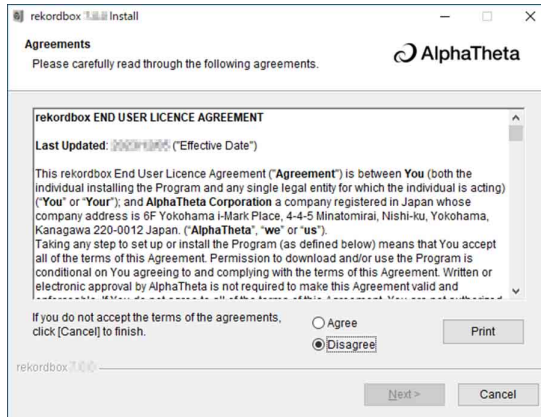

- If you do not agree to the contents of the license agreement, click **[Cancel]** to cancel the installation.
- After specifying the destination, the installation will start. When the installation is finished, a completion message will be displayed.

- 4 Click **[Finish]** to complete the installation.

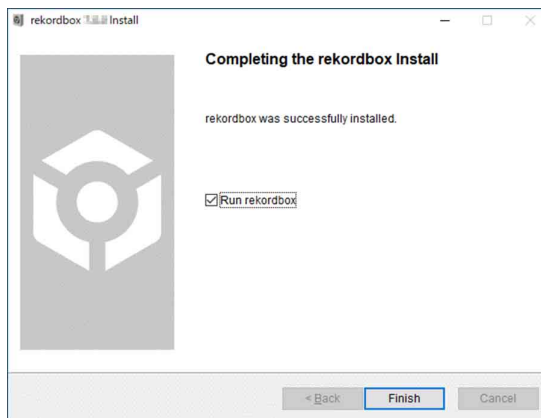

Installation is complete.

## Basic use

---

### Starting rekordbox for Mac/Windows

You need to register an AlphaTheta account to use rekordbox for Mac/Windows.

For details, refer to the rekordbox Introduction.

#### For Mac

In Finder, open the **[Applications]** folder, then double-click the **[rekordbox 7] > [rekordbox.app]** icon.

#### For Windows 11

In the **[Start]** menu, open the **[All apps]** screen, then click the **[rekordbox 7]** icon under **[rekordbox]**.

#### For Windows 10

In the **[Start]** menu, click the **[rekordbox 7]** icon under **[rekordbox]**.

## Checking audio setup

Check that the **[Audio]** settings in **[Preferences]** in rekordbox for Mac/Windows are set as follows:

### For Mac

**[Audio]: [DDJ-GRV6]**

**[Output channels]:**

**[Master Output]: [DDJ-GRV6 : MASTER + audio device name on Mac]**

**[Headphones Output]: [DDJ-GRV6 : PHONES]**

- When PC MASTER OUT is off, **[Master Output]** in the **[Audio]** setting is **[DDJ-GRV6 : MASTER]**.

### For Windows

**[Audio]: [DDJ-GRV6 WASAPI]**

**[Output channels]:**

**[Master Output]: [DDJ-GRV6 WASAPI : MASTER + audio device name on PC]**

**[Headphones Output]: [DDJ-GRV6 WASAPI : PHONES]**

- When PC MASTER OUT is off, **[Master Output]** in the **[Audio]** setting is **[DDJ-GRV6 WASAPI : MASTER]**.
- PC Master Out is a function that can output the master sound of rekordbox for Mac/Windows from the speaker(s) of the connected PC/Mac. By default, PC Master Out is set to on.
- To cancel outputting the master sound of rekordbox for Mac/Windows from the speaker(s) of the connected PC/Mac, click  in the top-right area of the rekordbox for Mac/Windows screen so its light switches off.

---

## Adding music files into your Collection

The **[Collection]** screen contains a list of music files managed by rekordbox for Mac/Windows.

Add music files on your PC/Mac to your Collection so the software can analyze them and they can be used in rekordbox for Mac/Windows.

- 1 Click **[Collection]** in **[Media Browser]**.  
A list of tracks in your **[Collection]** is displayed.
- 2 Open Finder (Mac) or Explorer (Windows) and drag and drop music files, or folders containing music files, into the track list.  
Music files are added into the **[Collection]** and analysis for the music files begins. Wait until analysis of all music files is complete.

---

## Loading an audio track onto a deck

The following explains how to load a track onto deck 1 as an example.

Turn the smart rotary selector to select a track in your **[Collection]** and press the **[LOAD 1]** button.

The track loads onto deck 1.

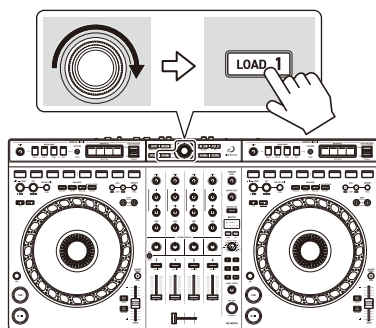



---

## Playing a track

This section explains how to play sound from deck 1 (left) as an example.

- 1 Set the positions of the knobs, etc. as follows:
  - **[TRIM]** knob: turned fully counterclockwise
  - EQ **[HI/MID/LOW]** knobs: center position (12 o'clock)
  - **[SOUND COLOR FX]** knob: center position
  - Channel fader: bottom position
  - **[MASTER LEVEL]** knob: turned fully counterclockwise
  - Crossfader: center position
- 2 Press the **[▶/|| (play/pause)]** button to play the track.

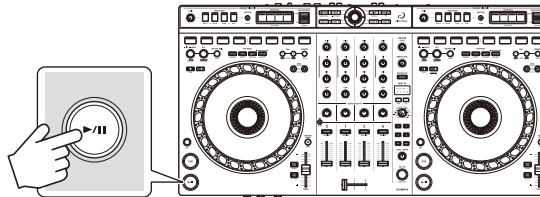

- 3 Turn the **[TRIM]** knob.

Adjust the **[TRIM]** knob so the channel level indicator lights up orange at the loudest part of the track.

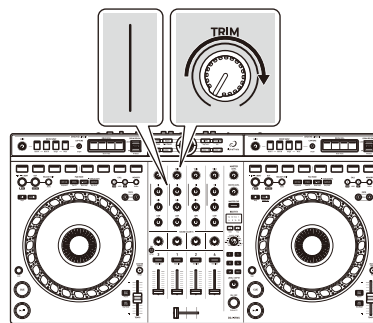

# rekordbox for Mac/Windows

4 Move the channel fader to the top.

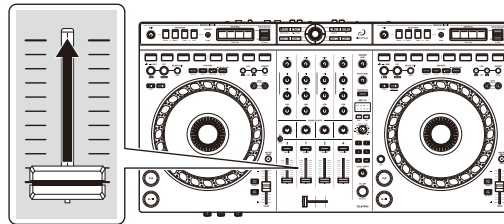

5 Turn the **[MASTER LEVEL]** knob to adjust the volume of the speakers to a level you're happy with.

Adjust the volume of sound output from the **[MASTER 1]** output terminals or **[MASTER 2]** output terminals.

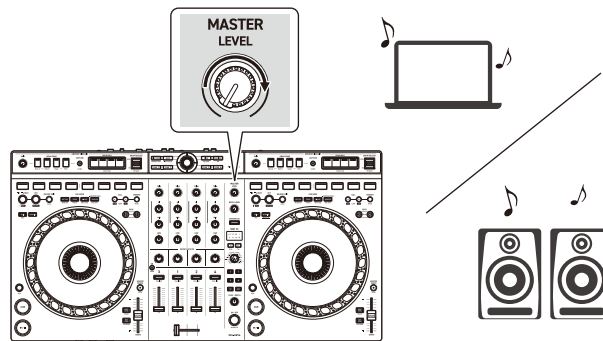



- If you're outputting sound from the speaker of your PC/Mac, adjust the speaker volume on the PC/Mac instead of using the **[MASTER LEVEL]** knob.
- If you can't output sound from the **[MASTER 1]** output terminals or **[MASTER 2]** output terminals or the unit isn't recognized by your PC/Mac, refer to the **[FAQ]** on the AlphaTheta support website.

[alphatheta.com/support/](http://alphatheta.com/support/)

## Monitoring with headphones

This section explains how to play sound from deck 1 (left) as an example.

- 1 Set the positions of knobs, etc. as shown below.
  -  **(headphones) MIX** knob: Center
  -  **(headphones) LEVEL** knob: Turned fully counterclockwise
- 2 Press the headphones **[CUE]** button for channel 1.
- 3 Turn the  **(headphones) LEVEL** knob.  
Adjust the headphones volume to a level you're happy with.

---

## Quitting rekordbox

Click the **[x]** button or select **[Exit]** from the **[File]** menu.

---

## Turning off the unit

Disconnect the USB cable to turn the unit off.

---

---

## Advanced use

---

### Using 4 Beat Loop

While a track is playing, press and hold the **[IN]** button.

Loop playback starts with 4 beats from the point where you press the button.

- When the Quantize function is turned on, you might notice a slight delay as the loop synchronizes to the beat.

#### ❖ Canceling loop playback

Press the **[RELOOP/EXIT]** button.

When the loop out point is reached, the rest of the track continues to play without returning to the loop in point.

---

### Using Manual Loop

You can use Manual Loop to choose the section you want to loop in a track.

- When the Quantize function is turned on, you might notice a slight delay as the loop synchronizes to the beat.
- 1 During playback, press the **[IN]** button at the point you want to start looping (the loop in point).
  - 2 Press the **[OUT]** button at the point you want the loop to end (the loop out point).  
Loop playback starts.

## ❖ Cutting the loop

Press the **[CALL ◀]** button during loop playback.

Each time you press the button, the loop cuts in half.

- You can cut the loop length in half even during 4 Beat Loop playback.

## ❖ Extending the loop

Press the **[CALL ▶]** button during loop playback.

Each time you press the button, the loop doubles in length.

- You can double the loop length even during 4 Beat Loop playback.

## ❖ Canceling a loop

Press the **[RELOOP/EXIT]** button.

The rest of the track continues to play without returning to the loop in point.

## ❖ Changing the loop in point

Press the **[IN]** button and turn the jog wheel during loop playback.

The loop in point changes.

## ❖ Changing the loop out point

Press the **[OUT]** button and turn the jog wheel during loop playback.

The loop out point changes.

---

## Using the Performance Pads

### ❖ Using Hot Cues

You can start playback instantly from the position where a Hot Cue is set. Loops can also be set and called up instantly.

- Up to 16 Hot Cues can be set and saved for each track in rekordbox for Mac/Windows. On the unit, up to 8 Hot Cues can be set and saved per track.

### Setting and calling up a Hot Cue

- 1 Press the **[HOT CUE]** mode button.

The unit enters Hot Cue mode.

- 2 When the track is playing or paused, press a Performance Pad to set a Hot Cue.

Hot Cues are set to Performance Pads as follows:



1: Hot Cue A, 2: Hot Cue B, 3: Hot Cue C, 4: Hot Cue D,  
5: Hot Cue E, 6: Hot Cue F, 7: Hot Cue G, 8: Hot Cue H

- 3 Press a Performance Pad you've set a Hot Cue for.

Playback starts from the Hot Cue point.

- You can clear Hot Cues by pressing a Performance Pad while holding the **[Shift]** button.

## Setting and calling up 4 Beat Loop

- 1 Press the **[HOT CUE]** mode button.  
The unit enters Hot Cue mode.
- 2 Press and hold down the **[IN]** button during playback.  
A loop with 4 beats is set at the position where you pressed the button, and loop playback starts.
- 3 Press a Performance Pad to set a loop during loop playback.
- 4 Press the Performance Pad.  
Loop playback starts from the loop in point.
  - You can clear the loop by pressing the Performance Pad while holding the **[Shift]** button.

## Setting and calling up Manual Loop

- 1 Press the **[HOT CUE]** mode button.  
The unit enters Hot Cue mode.
- 2 Press the **[IN]** button during playback, and press the **[OUT]** button.  
Loop playback starts.
- 3 Press a Performance Pad to set a loop during the loop playback.
- 4 Press the Performance Pad.  
Loop playback starts from the loop in point.
  - You can clear the loop by pressing the Performance Pad while holding the **[Shift]** button.

## ❖ Using Stems

You can switch the output for each Stem (Vocal/Inst/Drums) of the track and select a Stem you want to apply an effect to.

- 1 Press the **[STEMS]** mode button.

The unit enters Stems mode.

Each Stem is set to the Performance Pads as follows:



1: Vocal Stem, 2: Inst Stem, 3: Drums Stem, 4: Not assigned,  
5: Selecting the effect for Vocal Stem, 6: Selecting the effect for Inst Stem,  
7: Selecting the effect for Drums Stem, 8: Not assigned

- 2 Press one of Performance Pad 1 through 3.

Output setting of each Stem is changed.

Only stems set to lit pads are output.

- 3 Press one of Performance Pad 5 through 7.

Select a Stem you want to apply an effect to.

Only stems set to lit pads are applied with an effect.

## ❖ Using Beat Jump

You can move the playback position instantly, without breaking the rhythm of the track that's playing.

- 1 Press the **[B.JUMP]** mode button.

The unit enters Beat Jump mode.

The number of beats set to the Performance Pads are as follows (Default):



1: 1 beat (left direction), 2: 1 beat (right direction), 3: 2 beats (left direction),  
4: 2 beats (right direction), 5: 4 beats (left direction), 6: 4 beats (right direction),  
7: 8 beats (left direction), 8: 8 beats (right direction)



# rekordbox for Mac/Windows

- 2 Press Performance Pad 7 or 8 while holding the **[Shift]** button to change the number of beats set to the Performance Pad.

When pressing Performance Pad 7 while holding the **[Shift]** button, the number of beats decreases.

When pressing Performance Pad 8 while holding the **[Shift]** button, the number of beats increases.



7: Number of beats goes down, 8: Number of beats goes up

- 3 Press a Performance Pad.
  - Pad 1, 3, 5 or 7: The playback position is moved to the left by the number of beats set on the pad.
  - Pad 2, 4, 6 or 8: The playback position is moved to the right by the number of beats set on the pad.

## ❖ Using Sampler

You can use the Performance Pads to play tracks or sounds assigned to the Sampler slots.

### Preparing to use Sampler

Press and hold down the **[SAMPLER]** mode button to display the **[SAMPLER]** panel.

### Loading a track into a Sampler slot

- 1 Press the **[SAMPLER]** mode button.  
The unit enters Sampler mode.
- 2 Click the button at the right of **[BANK]** on the **[SAMPLER]** panel in rekordbox for Mac/Windows to change the Sampler bank.



# rekordbox for Mac/Windows

In rekordbox for Mac/Windows, the sampler has 4 banks, and each bank has 16 slots.

- 3 Press the smart rotary selector to move the cursor to the track list.
- 4 Turn the smart rotary selector.  
Select a track you want to load into a Sampler slot.
- 5 Press a Performance Pad while holding the **[Shift]** button.  
The selected track is loaded into the Sampler slot.
  - Loading a sound into a slot that already has a sound loaded may not be possible depending on the **[Preferences]** settings in rekordbox. You may need to clear the slot before loading the new sound.

## Playing Sampler sounds with Performance Pads

- 1 Press the **[SAMPLER]** mode button.  
The unit enters Sampler mode.
- 2 Click the button to the right of **[BANK]** on the **[SAMPLER]** panel in rekordbox for Mac/Windows to change the Sampler bank.
- 3 Turn the  **[GAIN]** on the **[SAMPLER]** panel to adjust the Sampler volume.
- 4 Press a Performance Pad.  
The track or sound assigned to the relevant slot is played.
  - Sampler slots are set to Performance Pads as follows. (The slots outside brackets are for when the Pad mode of deck 1 or deck 3 is set to Sampler mode. The slots in brackets are for when the Pad mode of deck 2 or deck 4 is set to Sampler mode.)



1: Slot 1 (slot 9), 2: Slot 2 (slot 10), 3: Slot 3 (slot 11), 4: Slot 4 (slot 12),  
5: Slot 5 (slot 13), 6: Slot 6 (slot 14), 7: Slot 7 (slot 15), 8: Slot 8 (slot 16)

- 5 During Sampler playback, press the Performance Pad again.  
The sound plays from the beginning again.
- 6 Press a Performance Pad while holding the **[Shift]** button during Sampler playback.  
The sound of the slot that is currently playing stops.

## ❖ Using Keyboard mode

Use Performance Pads to play a Hot Cue in different pitches, as if you're using a keyboard.

- 1 Press the **[HOT CUE]** mode button while holding the **[Shift]** button.  
The unit enters Keyboard mode.
- 2 Press a Performance Pad.

Select the Hot Cue you want to use with Keyboard mode.

- If no Hot Cue is set, the current playback position is set as a Hot Cue. After selecting the Hot Cue which you set, the Hot Cue is used with Keyboard mode.
- To reselect a Hot Cue, press the **[HOT CUE]** mode button while holding the **[Shift]** button.

When the Hot Cue is selected, the various pitches are set to the Performance Pads as follows (Default):



1:  $\pm 0$  Semitones, 2: +1 Semitones, 3: +2 Semitones, 4: +3 Semitones,  
5: +4 Semitones, 6: +5 Semitones, 7: +6 Semitones, 8: +7 Semitones

A semitone is a unit used to determine the pitch of a sound. +1 semitone means the sound is higher in pitch than the original sound by half.

- 3 Press Performance Pad 7 or 8 while holding the **[Shift]** button to change the pitch set to the Performance Pad.
  - Pad 7: The page changes and the pitch of the sound falls.
  - Pad 8: The page changes and the pitch of the sound rises.

# rekordbox for Mac/Windows



1 through 6: Deleting Hot Cue, 7: Changing pages, 8: Changing pages

## 4 Press a Performance Pad.

Playback starts from the Hot Cue point, with the sound pitch assigned to that pad.

- To delete the Hot Cue, press one of the Performance Pad 1 through 6 while holding the **[Shift]** button.

## ❖ Using Pad FX

You can add a wide range of effects to your performances simply by pressing and releasing the Performance Pads.

### 1 Press the **[STEMS]** mode button while holding the **[Shift]** button.

The unit enters Pad FX mode.

Effects are set to the Performance Pads as follows:



Without holding the **[Shift]** button

- 1: Effect A, 2: Effect B, 3: Effect C, 4: Effect D,  
5: Effect E, 6: Effect F, 7: Effect G, 8: Effect H

While holding the **[Shift]** button

- 1: Effect I, 2: Effect J, 3: Effect K, 4: Effect L,  
5: Effect M, 6: Effect N, 7: Effect O, 8: Effect P

### 2 Press and hold down a Performance Pad, or press and hold down a Performance Pad while holding the **[Shift]** button.

The effect turns on. The sound changes according to the type of effect and the number of beats in the settings assigned to that pad.

### 3 Release the Performance Pad.

The effect turns off.

## Using Release FX of Pad FX

You need to assign a Release FX to a Performance Pad in advance.

- 1 Press and hold down a Performance Pad that has an effect other than a Release FX assigned to it, or press and hold down a Performance Pad while holding the **[Shift]** button.  
The effect turns on. The sound changes according to the type of effect and the number of beats in the settings assigned to that pad.
- 2 Press the Performance Pad that has a Release FX assigned to it, and release it.  
Or press a Performance Pad while holding the **[Shift]** button, and release it.  
The effect turns off, and the Release FX is added.

## ❖ Using Beat Loop

If you press a Performance Pad, a loop with the number of beats assigned to the pad is set. The loop keeps playing after you remove your finger from the pad.

- 1 Press the **[B.JUMP]** mode button while holding the **[Shift]** button.  
The unit enters Beat Loop mode.  
The number of beats set to the Performance Pads are as follows:



1: Beat Loop 1/4 beat, 2: Beat Loop 1/2 beat, 3: Beat Loop 1 beat,  
4: Beat Loop 2 beats, 5: Beat Loop 4 beats, 6: Beat Loop 8 beats,  
7: Beat Loop 16 beats, 8: Beat Loop 32 beats

- 2 Press a Performance Pad.  
The loop plays with the number of beats set on that pad.
- 3 Press the same Performance Pad again.  
The loop is canceled and the rest of the track continues to play.

## ❖ Using Key Shift

When you press a Performance Pad in Key Shift mode, the key of the track that's currently playing is changed to the pitch set to the pressed pad.

- 1 Press the **[SAMPLER]** mode button while holding the **[Shift]** button.

The unit enters Key Shift mode.

The various pitches are set to the Performance Pads as follows (Default):



1:  $\pm 0$  Semitones, 2: +1 Semitones, 3: +2 Semitones, 4: +3 Semitones, 5: +4 Semitones, 6: +5 Semitones, 7: +6 Semitones, 8: +7 Semitones  
A semitone is a unit used to determine the pitch of a sound. +1 semitone means the sound is higher in pitch than the original sound by half.

- 2 Press Performance Pad 7 or 8 while holding the **[Shift]** button to change the pitch set to the Performance Pad.
  - Pad 7: The page changes and the pitch of the sound falls.
  - Pad 8: The page changes and the pitch of the sound rises.



7: Changing pages, 8: Changing pages

- 3 Press a Performance Pad.

The track's key is changed to the pitch assigned to the pad.

## Setting and calling up a cue point or loop point

### ❖ Setting a cue point or loop point

- 1 Pause the track and move the playback position to where you want to set a cue point or loop point.
- 2 Press the **[CUE]** button while the track is paused.
- 3 Press the **[MEMORY]** button.  
The cue point or loop point is saved.

### ❖ Calling up the cue point or loop point

Press the **[CALL ►]** button or **[CALL ◀]** button.  
The cue point or loop point is called up.

### ❖ Deleting the cue point or loop point

- 1 Press the **[CALL ►]** button or **[CALL ◀]** button.  
The cue point or loop point is called up.
- 2 Press the **[MEMORY]** button while holding the **[Shift]** button.  
The cue point or loop point is deleted.

## Using Slip

If you turn Slip mode on, normal playback continues in the background while you scratch, play a loop, or play a Hot Cue. When you stop scratching or playing the loop or Hot Cue, normal playback resumes from the position reached in the background.

- The **[SLIP]** button lights up when Slip mode is on, and flashes during playback in the background.

### ❖ Slip Scratch Play

- 1 Make sure Vinyl mode is turned on.  
Check that the **[SLIP]** button lights up while holding the **[Shift]** button.
  - For the default setting, Vinyl mode is on.
- 2 Press the **[SLIP]** button.  
The unit enters Slip mode.
- 3 To scratch the track, turn the top of the jog wheel during playback.  
Normal playback continues in the background while you're scratching.
- 4 Release the top of the jog wheel.  
Playback starts from the position reached in the background.
  - To cancel Slip mode, press the **[SLIP]** button again.

### ❖ Slip Hot Cue

- 1 Press the **[HOT CUE]** mode button.  
The unit enters Hot Cue mode.
- 2 Press the Performance Pad to set the Hot Cue.
- 3 Press the **[SLIP]** button.  
The unit enters Slip mode.



- 4 Press and hold a Performance Pad during playback.  
Playback starts from the Hot Cue point. While holding the pad, playback continues.  
Normal playback continues in the background during Hot Cue playback.

- 5 Release the Performance Pad.  
Playback starts from the position reached in the background.
  - To cancel Slip mode, press the **[SLIP]** button again.

## ❖ Slip Braking

- 1 Adjust the **[Vinyl Speed Adjust] - [Touch/Brake]** setting in the **[Preferences] > [Controller] > [Deck]** in rekordbox.  
With the **[Vinyl Speed Adjust]** setting, you can adjust the speed at which a track slows down until it stops.  
When using Slip Braking, adjust **[Touch/Brake]** in **[Vinyl Speed Adjust]** to stop slowly.
- 2 Press the **[SLIP]** button.  
The unit enters Slip mode.
- 3 Press the **[▶/|| (play/pause)]** button during playback.  
Playback slows down gradually and stops. Normal playback continues in the background.
- 4 Press the **[▶/|| (play/pause)]** button again.  
Playback starts from the position reached in the background.
  - To cancel Slip mode, press the **[SLIP]** button again.

## ❖ Slip Auto Beat Loop

- 1 Press the **[SLIP]** button.  
The unit enters Slip mode.
- 2 Press the **[IN]** button.  
A 4-beat loop is set, and loop playback starts.  
Normal playback continues in the background during loop playback.
- 3 Press the **[RELOOP/EXIT]** button.  
The loop is canceled and playback starts from the position reached in the background.
  - To cancel Slip mode, press the **[SLIP]** button again.

## ❖ Slip Manual Loop

- 1 Press the **[SLIP]** button.  
The unit enters Slip mode.
- 2 Press the **[IN]** button, then press the **[OUT]** button.  
Loop playback starts.  
Normal playback continues in the background during loop playback.
- 3 Press the **[RELOOP/EXIT]** button.  
The loop is canceled and playback resumes from the position reached in the background.
  - To cancel Slip mode, press the **[SLIP]** button again.

---

## Using Fader Start

### ❖ Using Channel Fader Start

- 1 Set the cue point.  
Pause the track at the position you want to start playback from, then press the **[CUE]** button on that deck.

- 2 While holding the **[Shift]** button, move the channel fader from the bottom to the top.

Playback starts from the cue point.

- If you move the channel fader back to the bottom while holding the **[Shift]** button during playback, the track instantly jumps back to the cue point and playback pauses. (Back Cue)

When no cue point is set, playback starts from the beginning of the track.

## ❖ Using Crossfader Start

- 1 Set the cue point.

Pause the track at the position you want to start playback from, then press the **[CUE]** button on that deck.

- 2 Move the crossfader all the way to the left or right side.

If you want to use Crossfader Start to trigger playback on channel 2, set the crossfader to the left side, and vice versa.

- 3 While holding the **[Shift]** button, move the crossfader towards the opposite side from where it's set.

Playback starts from the cue point.

- If you move the crossfader back while holding the **[Shift]** button during playback, the playback position instantly jumps back to the cue point and pauses. (Back Cue)

When no cue point is set, playback starts from the beginning of the track.

## Using Dual Deck mode

You can simultaneously control Deck 1 and 3 (or Deck 2 and 4) in Dual Deck mode.

You can scratch or play a loop/Hot Cue, etc., as if the two different tracks of the two different decks are combined as one track.

- 1 Press the **[DECK 3]** button while holding the **[DECK 1]** button, or press the **[DECK 1]** button while holding the **[DECK 3]** button. The unit enters Dual Deck mode. The **[DECK]** button pressed first will flash, and the **[DECK]** button pressed next will light up.
  - When the unit enters Dual Deck mode, the deck status of the **[DECK]** button pressed first is displayed.
  - To cancel Dual Deck mode, press the **[DECK 1]** button or **[DECK 3]** button. The operating deck switches to the deck whose **[DECK]** button was pressed.

You can simultaneously control the following functions in Dual Deck mode with the relevant buttons and knobs in both decks.

Buttons/knobs	Functions
Jog wheel	Scratch, Pitch Bend
SLIP button	Slip mode, Vinyl mode
QUANTIZE button	Quantize function
MASTER TEMPO button	Master Tempo
IN button	Loop in, Loop in adjust, 4 Beet Loop
OUT button	Loop out, Loop out adjust
RELOOP/EXIT button	Reloop/exit
CALL ◀ button	Loop half
CALL ▶ button	Loop double
HOT CUE mode button	Hot Cue mode, Keyboard mode
STEMS mode button	Pad FX mode

# rekordbox for Mac/Windows

Buttons/knobs	Functions
B.JUMP mode button	Beat Jump mode, Beat Loop mode
SAMPLER mode button	Key Shift mode
Performance Pads	Pad modes of each pad (except for Stems mode and Sampler mode)
▶/   (play/pause) button	Playback/pause
CUE button	Cue settings, Back Cue, Cue Point Sampler
BEAT SYNC button	Sync mode
KEY SYNC button	Key Sync, Key Reset

You can control the following functions in Dual Deck mode with the relevant buttons and knobs on the deck with the flashing **[DECK]** button.

Buttons/knobs	Functions
TEMPO slider	Tempo adjustment
MASTER TEMPO button	Tempo range
CALL ◀ button	Calling up a Hot Cue or Loop point saved on the track
CALL ▶ button	Calling up a Hot Cue or Loop point saved on the track
MEMORY button	Saving/deleting a Cue point or Loop point
RELOOP/EXIT button	Active Loop

- If the following modes are differently set in each deck, modes on the deck with the flashing **[DECK]** button will be used.
  - Vinyl mode
  - Pad mode
  - Slip mode

- The Groove Circuit section is not applicable to Dural Deck mode.

---

## Using Groove Circuit

You can easily arrange a track by replacing with the other beat or adding a new beat for the Drums Stem of the track loaded on the deck.

### ❖ Loading a Drum Loop sound source into the Drum Swap Slot

Drag the Drum Loop sound source from the track list of rekordbox for Mac/Windows and drop it into the Drum Swap Slot.

- You can also load Drum Loop sound sources all at once to Drum Swap 1 to 4 with using the **[Load Drum Preset]** button on rekordbox for Mac/Windows. For details, see the rekordbox Instruction Manual.

### ❖ Playing the Drum Loop sound source

Press one of the **[DRUM SWAP 1-4]** buttons.

Starts playback of the Drum Loop sound source assigned to the pressed button.

To stop playback, press the same button again.

- The Drum Loop sound source being played by Drum Swap will be played in a loop (with 32 beats or less).
- The Drum Loop sound source being played by Drum Swap will be synchronized to the beat position and BPM of the track loaded on the deck.
- To synchronize to the beat position and BPM of the track loaded on the deck, analysis or BPM settings in the Grid panel is required in advance. For details, see the rekordbox Instruction Manual.
- Turn the **[GAIN]** knob to adjust the overall volume of Drum Swap 1 to 4.

## ❖ Switching the bank of the Drum Loop sound source

The Drum Loop sound source has two banks for each deck.

Press the **[DRUM SWAP 1]** button while holding the **[Shift]** button.

Switch the Drum Loop sound source of the **[DRUM SWAP 1-4]** button to the Sample sound source of Drum Loop Bank A.

Press the **[DRUM SWAP 2]** button while holding the **[Shift]** button.

Switch the Drum Loop sound source of the **[DRUM SWAP 1-4]** button to the Sample sound source of Drum Loop Bank B.

- For Drum Swap Multi mode, you can play four sound sources of Bank A and B at the same time.

## ❖ Selecting playback mode for the Drum Loop sound source

You can select playback mode for the Drum Loop sound source from Drum Swap Single mode and Drum Swap Multi mode.

Press the **[DRUM SWAP 3]** button while holding the **[Shift]** button.

Playback mode for the Drum Loop sound source is set to Drum Swap Single mode.

In Drum Swap Single mode, the sound for Drums Stem of the track loaded into the deck will be switched to the Drum Loop sound source.

- When playing Drum Swap, Stem Mute (Drums) on the deck will be turned off (muted).
- When stopping Drum Swap, Stem Mute (Drums) on the deck will be turned on.

Press the **[DRUM SWAP 4]** button while holding the **[Shift]** button.

Playback mode for the Drum Loop sound source is set to Drum Swap Multi mode.

In Drum Swap Multi mode, the Drum Loop sound source that has started playback is added, and the multiple Drum Loop sound sources will be played.

## ❖ Applying the Roll effect to the Drum Loop sound source and Drums Stem

Effects and beats are set to the **[DRUM ROLL]** buttons as follows.

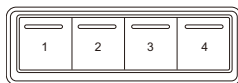

1: Roll (1/8 beat), 2: Roll (1/4 beat), 3: Roll (1/2 beat), 4: Roll (1 beat)

Press and hold down a **[DRUM ROLL]** button.

The Roll effect is applied to the Drum Loop sound source and Drums Stem on the deck.

- If the Drum Loop sound source isn't played, the effect is applied to Drums Stem.
- When releasing the button, the Roll effect will be canceled.

## ❖ Applying the Trans effect to the Drum Loop sound source and Drums Stem

While holding the **[Shift]** button, effects and beats are set to the **[DRUM ROLL]** buttons as follows.

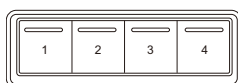

1: Trans (1/8 beat), 2: Trans (1/4 beat), 3: Trans (1/2 beat), 4: Trans (1 beat)

Press and hold down a **[DRUM ROLL]** button while holding the **[Shift]** button.

The Trans effect is applied to the Drum Loop sound source and Drums Stem on the deck.

- If the Drum Loop sound source isn't played, the effect is applied to Drums Stem.
- When releasing the button, the Trans effect will be canceled.



## ❖ Applying the Drum Release FX to the Drum Loop sound source and Drums Stem

Tilt and hold the **[DRUM RELEASE]** lever forward or backward.

The Drum Release FX is applied to the Drum Loop sound source and Drums Stem on the deck.

- The effect is applied to Drums Stem even when the Drum Loop sound source is not playing.
- When tilting the **[DRUM RELEASE]** lever back to the center position, the Drum Release FX will be canceled.

## ❖ Replacing the Drum Loop sound source

You can capture the Drums Stem of the track loaded onto the deck and load it to the **[DRUM SWAP]** button.

- 1 Load a track onto the deck.
- 2 Press the **[CAPTURE]** button at the beginning of the Drums Stem range you want to capture.

The range is set starting from the position where the button is pressed.

- To change the range, press the **[CAPTURE]** button while holding the **[Shift]** button.

**[4 beats] → [8 beats] → [16 beats] → [32 beats] → [4 beats]**

- You can't replace the Drum Loop sound source loaded to the **[DRUM SWAP]** button during playback.

- 3 Press one of the **[DRUM SWAP 1-4]** buttons.

The Drums Stem sound within the range set in step 2 will be load to the **[DRUM SWAP]** button you pressed.

- Press the **[DRUM SWAP]** button after loading, the replaced Drum Loop sound source will be played.

---

## Analyzing tracks

Track analysis starts when you drag and drop a music file, or a folder containing music files, into the Track List in rekordbox for Mac/Windows.

- If a track is loaded to a deck before analysis is complete, it may take some time to display its BPM and waveform.
- Depending on the number of tracks, analysis may take some time.

---

## Using Beat FX

You can apply effects that match the tempo (BPM) of the track loaded on the deck.

- 1 Press the **[BEAT ◀]** button or **[BEAT ▶]** button while holding the **[Shift]** button.  
Selects the BPM measurement mode.
  - **[AUTO]**: Press the **[BEAT ◀]** button while holding the **[Shift]** button. The BPM is automatically measured from the input audio signal.
  - **[TAP]**: Press the **[BEAT ▶]** button while holding the **[Shift]** button. You can enter the BPM manually by tapping the **[TAP]** button.
- 2 Turn the **[BEAT FX SELECT]** knob.  
Selects a type of effect.  
The first effect type on the FX1 unit in rekordbox will be changed.
- 3 Press the **[BEAT FX CH SELECT]** button.  
Selects a channel to apply the effect to.
  - **[1]** to **[4]**: Applies the effect to the sound of the respective channel.
  - **[SP]**: Applies the effect to the sampler sound.
  - **[MST]**: Applies the effect to the sound of the master channel.
- 4 Press the **[BEAT ◀]** button or **[BEAT ▶]** button.  
Sets the number of beats synchronized to the effect sound.  
The effect time corresponding to the number of beats is set automatically.

- 5 Press the **[BEAT FX ON/OFF]** button.

The effect is applied to the sound.

You can adjust the effect's parameter by turning the **[BEAT FX LEVEL/DEPTH]** knob.

The **[BEAT FX ON/OFF]** button flashes when the effect is turned on.

- Press the **[BEAT FX ON/OFF]** button again to turn the effect off.

---

## Using a microphone

- 1 Connect a microphone to the **[MIC]** input terminal.

- 2 Turn the **[MIC LEVEL]** knob.

Adjust the volume of the sound output from the **[MIC]** input terminal.

- The sound comes out at a high volume if the knob is turned all the way to the right.

- 3 Talk into the microphone.

- You can't add effects to the microphone sound on this unit.

## Changing the settings in rekordbox for Mac/Windows

You can change the settings of the unit in rekordbox for Mac/Windows under **[Controller]** in **[Preferences]**.

When you connect the unit to rekordbox for Mac/Windows, you can change the following settings:

### **[Controller] > [Deck]:**

#### **[Back Spin Length]** setting

When using the Back Spin feature with the jog wheel, the length of the Back Spin is different from the length of the jog wheel rotation.

You can choose the length of the Back Spin from 3 options: short, normal, or long.

- **[short]**: Back Spin length short
- **[normal]**: Back Spin length normal
- **[long]**: Back Spin length long

#### **[Slip Mode Flashing]** setting

Set Slip Mode Flashing.

- **[Enable]**: When Slip mode is on, the buttons that can work in Slip mode will flash.
- **[Disable]**: When Slip mode is on, the buttons that can work in Slip mode won't flash.

#### **[Slip button LED while Slip mode is on]** setting

Set the lighting operation of the **[SLIP]** button when Slip mode is on.

- **[Light is On]**: When Slip mode is on, the **[SLIP]** button lights, and the button flashes during slip operation.
- **[Blink]**: When Slip mode is on, the **[SLIP]** button always flashes.

## **[Controller] > [Mixer]:**

### **[Fader Start]** setting

Change the setting of the Fader Start function.

Select **[Activate the fader start when moving a channel fader or the crossfader while pressing the SHIFT button.]** to turn the setting on.

### **[CROSSFADER] > [Cut Lag]** setting

Adjust the Cut Lag on both edges of the crossfader.

Units of 0.1 mm can be adjusted from 0.3 mm to 5.5 mm.

- The default Cut Lag amount is 1.0 mm.
- This Cut Lag setting is a guide, and may not be exact.

### **[Booth Output]** setting

Change whether or not the microphone sound comes out of the booth channel.

If you don't select **[Don't output microphone sound to the Booth output.]**, the microphone sound comes out of the booth channel. If you select the setting, microphone sound doesn't come out of the booth channel.

### **[Headphones]** setting

Change the output sound from the **[⌂ (headphones)]** output terminals.

- **[STEREO]**: Outputs the monitor sound in stereo.
- **[MONO SPLIT]**: Outputs the monitor sound other than the master sound from the left channel and the monitor sound of the master sound from the right channel.

## **[Controller] > [DDJ-GRV6]:**

### **[REC OUT]** setting

Set whether to output microphone sound to the REC output.

If you set **[Mix the MIC audio to REC OUT]**, the microphone sound can be output to the REC output.

## **[Demo mode]** setting

Set the time to pass before Demo mode starts.

The default setting is **[10 minutes]**.

To cancel Demo mode, operate any knob or button on the unit.

- **[1 minute]**: Demo mode starts when there is no operation on the unit for 1 minute.
- **[5 minutes]**: Demo mode starts when there is no operation on the unit for 5 minutes.
- **[10 minutes]**: Demo mode starts when there is no operation on the unit for 10 minutes.
- **[Off]**: Demo mode never starts.

## **[Power Management]** setting

When the Power Management function is set to **[Enable]**, the unit enters Off mode automatically after 20 minutes if the unit is not operated without audio signal input to each channel.

During Off mode, the **[QUANTIZE]** button in the right deck is lit.

To cancel Off mode, press the lit **[QUANTIZE]** button.

- The default setting of the Power management function is **[Enable]**.
- To cancel the Power Management function, set to **[Disable]**.
- If the Power Management function is set to **[Disable]**, power consumption may increase.

---

---

# Serato DJ Pro

---

---

## Installing Serato DJ Pro

### ❖ Installing (Mac)

**Do not connect the unit to your Mac until installation is complete.**

- Close all programs on your Mac.

- 1 Unzip the downloaded Serato DJ Pro software file.
- 2 Double-click the unzipped software file to launch the installer.
- 3 Read the terms of the License Agreement carefully and if you agree, click **[Agree]**.

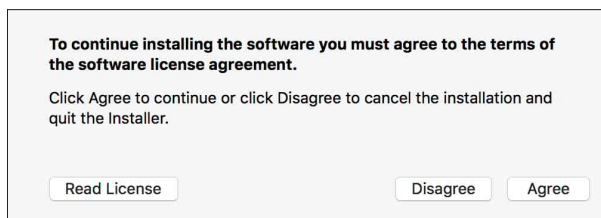

- If you don't agree to the contents of the License Agreement, click **[Disagree]** to cancel the installation.
- 4 Click **[Install]**.
  - 5 Follow the on-screen instructions to install the software.

6 Click **[Close]** to quit the installer.

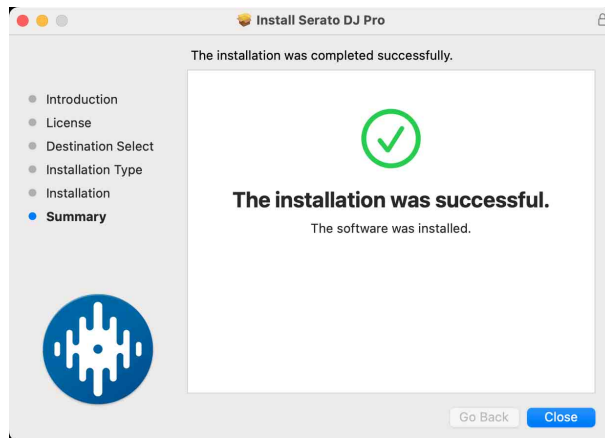

## ❖ Installing (Windows)

**Do not connect the unit to your PC until installation is complete.**

- Log into your PC as an administrator before starting the installation.
- Close all programs on your PC.

- 1 Unzip the downloaded Serato DJ Pro software file.
- 2 Double-click the unzipped software file to launch the installer.
- 3 Read the terms of the License Agreement carefully and if you agree, select **[I agree to the license terms and conditions]**, then click **[Install]**.
  - If you don't agree to the contents of the License Agreement, click **[Close]** to cancel the installation.





A message indicating successful installation appears when installation is complete.

- 4 Click **[Close]** to quit the Serato DJ Pro installer.

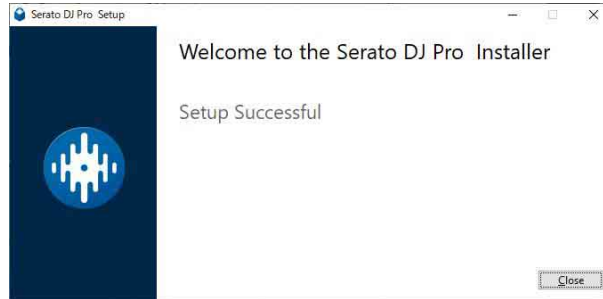

## Basic use

### Starting Serato DJ Pro

This manual mainly focuses on explaining the hardware functions of the unit. For detailed instructions on using the Serato DJ Pro software, see the Serato DJ Pro software manual.

#### For Mac

In Finder, open the **[Applications]** folder, then double-click the **[Serato DJ Pro]** icon.

#### For Windows 11

In the **[Start]** menu, open the **[All apps]** screen, then click the **[Serato DJ Pro]** icon under **[Serato]**.

#### For Windows 10

From the **[Start]** menu, click **[Serato] > [Serato DJ Pro]** icon.

The following screen shows after Serato DJ Pro launches:

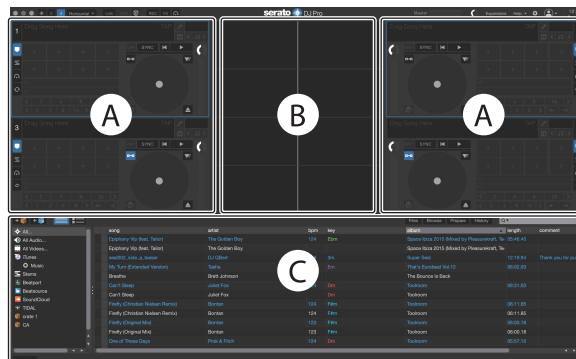

- With using the DDJ-GRV6, you don't need to activate or purchase a license to use Serato DJ Pro. But you may wish to purchase the Pitch 'n Time expansion to use Key change features.

[serato.com/dj/pro/expansions/pitchntimedj](https://serato.com/dj/pro/expansions/pitchntimedj)

When starting Serato DJ Pro with the DDJ-GRV6 for the first time, **[Login to Serato.com]** may appear on the right of the screen. In that case, login with your account to activate the expansion pack.

**The following screen shows when tracks are loaded onto decks in Serato DJ Pro:**

Click **[Library]** in the top-left corner of the screen, then select **[Vertical]** or **[Horizontal]** from the pull-down menu to change the screen layout.



## A Deck section

Track information (track name, artist name, BPM, etc.), the overall waveform, and other information about the loaded track is displayed.

## B Waveform display

The waveform of the loaded track is displayed.

## C Browse section

Tracks in the library, or crates containing multiple tracks, are displayed.

## Importing music files (tracks)

- There are various ways to import tracks into Serato DJ Pro. For details, see the Serato DJ Pro software manual.
- If you've previously used Serato Limited's DJ software (e.g. Scratch Live, ITCH, or Serato DJ Intro) and you've already created track libraries, you can use these libraries with Serato DJ Pro.
- If you've previously used Serato DJ Intro and you've already created track libraries, you may need to reanalyze tracks to use them with Serato DJ Pro.

The typical way to import music files (tracks) is as follows:

- 1 Click the **[Files]** button in the Serato DJ Pro screen to open the **[Files]** panel.  
The contents of your PC/Mac and the hard drive/device connected to the PC/Mac are displayed in the **[Files]** panel.
- 2 Click the folder containing the tracks you want to add to your library.
- 3 Drag and drop the selected folder to the crates panel.  
A crate is created and the tracks are added to your library.



A **[Files]** panel

B Crates panel

## Loading an audio track onto a deck

The following explains how to load a track onto deck 1 as an example:

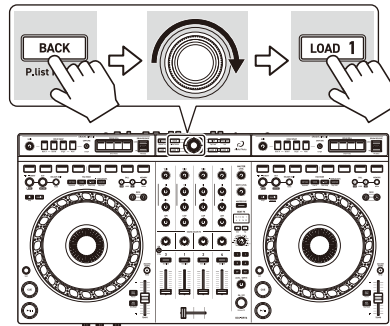

- 1 Press the **[BACK]** button on the unit to move the cursor to the crates panel on the Serato DJ Pro software screen, then turn the smart rotary selector to select a crate, etc.
- 2 Press the smart rotary selector to move the cursor to the library of the Serato DJ Pro software screen, then turn the smart rotary selector to select the track you want to load.



A Library  
B Crates panel

- 3 Press the **[LOAD 1]** button.  
The track loads onto deck 1.

---

## Playing a track

This section explains how to play sound from deck 1 (left) as an example.

- 1 Set the positions of the knobs etc. as shown below.
  - **[TRIM]** knob: turned fully counterclockwise
  - EQ **[HI/MID/LOW]** knobs: center position (12 o'clock)
  - **[SOUND COLOR]** knob: center position
  - Channel fader: bottom position
  - **[MASTER LEVEL]** knob: turned fully counterclockwise
  - Crossfader: center position
- 2 Press the **[▶/|| (play/pause)]** button to play the track.

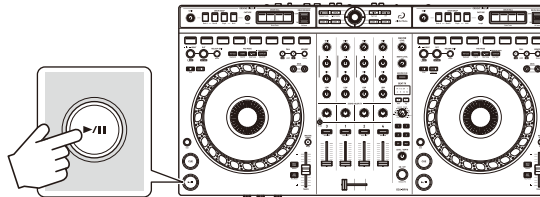

- 3 Turn the **[TRIM]** knob.

Adjust the **[TRIM]** knob so the channel level indicator lights up orange at the loudest part of the track.

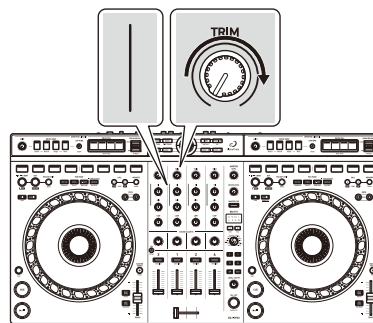

4 Move the channel fader to the top.

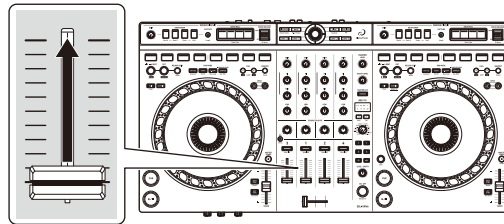

5 Turn the **[MASTER LEVEL]** knob to adjust the volume of the speakers to a level you're happy with.

Adjust the volume of sound output from the **[MASTER 1]** output terminals or **[MASTER 2]** output terminals.

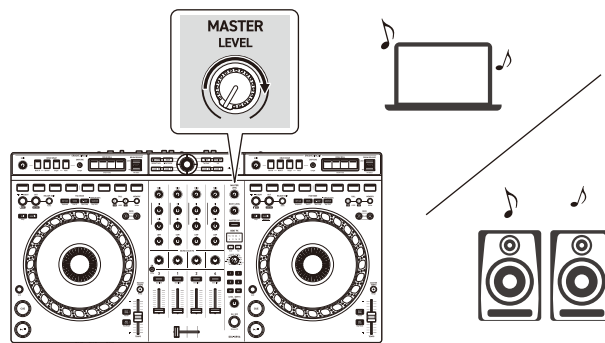

- If you can't output sound from the **[MASTER 1]** output terminals or **[MASTER 2]** output terminals or the unit isn't recognized by your PC/Mac, refer to the **[FAQ]** on the AlphaTheta support website.

[alphatheta.com/support/](http://alphatheta.com/support/)

---

## Monitoring with headphones

This section explains how to play sound from deck 1 (left) as an example.

- 1 Set the positions of knobs etc. as shown below.
  - [🎧 (headphones) MIX] knob: Center
  - [🎧 (headphones) LEVEL] knob: Turned fully counterclockwise
- 2 Press the headphones [CUE] button for channel 1.
- 3 Turn the [🎧 (headphones) LEVEL] knob.  
Adjust the headphones volume to a level you're happy with.

---

## Quitting Serato DJ Pro

Click the [x] button.

---

## Turning off the unit

Disconnect the USB cable to turn the unit off.



---

---

## Advanced use

---

---

### Using 4 Beat Loop

While a track is playing, press and hold the **[IN]** button.

Loop playback starts with 4 beats from the point where you press the button.

#### ❖ Canceling loop playback

Press the **[RELOOP/EXIT]** button.

When the loop out point is reached, the rest of the track continues to play without returning to the loop in point.

---

### Using Manual Loop

You can use Manual Loop to choose the section you want to loop in a track.

- 1 During playback, press the **[IN]** button at the point you want to start looping (the loop in point).
- 2 Press the **[OUT]** button at the point you want the loop to end (the loop out point).  
Loop playback starts.

## ❖ Cutting the loop

Press the **[CALL ◀]** button during loop playback.

Each time you press the button, the loop cuts in half.

- You can cut the loop length in half even during 4 Beat Loop playback.

## ❖ Extending the loop

Press the **[CALL ▶]** button during loop playback.

Each time you press the button, the loop doubles in length.

- You can double the loop length even during 4 Beat Loop playback.

## ❖ Canceling a loop

Press the **[RELOOP/EXIT]** button.

The rest of the track continues to play without returning to the loop in point.

---

## Using the Performance Pads

You can switch functions using the buttons for respective Pad modes: **[HOT CUE]**, **[STEMS]**, **[B.JUMP]**, and **[SAMPLER]**.

### ❖ Using Hot Cues

You can start playback instantly from the position where a Hot Cue is set.

- Up to 8 Hot Cues can be set and saved for each track in Serato DJ Pro.

- 1 Press the **[HOT CUE]** mode button.

The unit enters Hot Cue mode.

- 2 When the track is playing or paused, press a Performance Pad to set a Hot Cue.

The pad's settings are as shown below.



1: Hot Cue 1, 2: Hot Cue 2, 3: Hot Cue 3, 4: Hot Cue 4,  
5: Hot Cue 5, 6: Hot Cue 6, 7: Hot Cue 7, 8: Hot Cue 8

- 3 Press a Performance Pad you've set a Hot Cue for.

Playback starts from the Hot Cue point.

- You can clear Hot Cues by pressing a Performance Pad while holding the **[Shift]** button.

## ❖ Using Stems

You can switch the output for each Stem (Vocal/Melody/Bass/Drums) of the track and select a Stem you want to apply an effect to.

- 1 Press the **[STEMS]** mode button.

The unit enters Stems mode.

Each Stem and effect are set to the Performance Pads as follows:



1: Vocal Stem, 2: Melody Stem, 3: Bass Stem, 4: Drums Stem, 5: Vocal Echo, 6: Instrumental Echo, 7: Instrumental Braker, 8: Drums Echo

- 2 Press one of Performance Pad 1 through 4.

Output setting of each Stem is changed.

Stems set to lit pads are output.

- 3 Press one of Performance Pad 5 through 8.

Effects are applied to each Stem only.

## ❖ Using Beat Jump

You can use Beat Jump to move the playback position by different numbers of beats.

- 1 Press the **[B.JUMP]** mode button.

The unit enters Beat Jump mode.

- 2 Press a Performance Pad when the track is playing or paused.

The pad's settings are as shown below.



1: Beat Jump to the left, 2: Halve the Beat Jump length,  
 3: Double the Beat Jump length, 4: Beat Jump to the right,  
 5: Previous track, 6: Search ◀◀, 7: Search ▶▶, 8: Censor

## ❖ Using Sampler

You can use the Performance Pads to play tracks or sounds assigned to the Sampler slots.

- 1 Press and hold down the **[SAMPLER]** mode button.  
The **[SAMPLER]** panel appears in Serato DJ Pro.
- 2 Press the **[SAMPLER]** mode button on the unit.  
The unit enters Sampler mode.
- 3 Select a Sampler Bank in Serato DJ Pro.  
The Sampler bank changes.  
The sampler has 4 banks, A, B, C, and D, and each bank has 8 slots.
- 4 Drag and drop tracks or sounds from the library to load them into the **[SAMPLER]** panel's slots.  
The track is loaded into the Sampler slot.
- 5 Press a Performance Pad.  
The track or sound assigned to the relevant slot is played.
  - The playback method differs depending on the Sampler mode in Serato DJ Pro. For details, see the Serato DJ Pro software manual.



- 1: Slot 1, 2: Slot 2, 3: Slot 3, 4: Slot 4, 5: Slot 5, 6: Slot 6, 7: Slot 7, 8: Slot 8
- When you press a Performance Pad while holding the **[Shift]** button, the sound of the slot that is currently playing stops.

## ❖ Using Pitch Play

Pitch Play is a function of the Pitch 'n Time DJ expansion pack.

- To use Pitch 'n Time DJ, you'll need to buy and activate it first.

For details, visit the website below.

[serato.com/dj/pro/expansions/pitchtimedj](http://serato.com/dj/pro/expansions/pitchtimedj)

- 1 Press the **[HOT CUE]** mode button while holding the **[Shift]** button.  
The unit enters Pitch Play mode.
- 2 Press a Performance Pad while holding the **[Shift]** button.  
The Hot Cue point set on the Performance Pad is selected.
- 3 Press a Performance Pad.  
Playback starts from the selected Hot Cue point with the pitch set to the Performance Pad as follows.



1: -4 Semitones, 2: -3 Semitones, 3: -2 Semitones, 4: -1 Semitone,  
5: ±0 Semitones, 6: +1 Semitone, 7: +2 Semitones, 8: +3 Semitones

## ❖ Using Pad FX

You can add a wide range of effects to your performances simply by pressing and releasing the Performance Pads.

- 1 Press the **[STEMS]** mode button while holding the **[Shift]** button.  
The unit enters Pad FX mode.
- 2 Press and hold down a Performance Pad.  
The effect set on the Performance Pad turns on.  
The pad's settings are as shown below.



1: Effect A, 2: Effect B, 3: Effect C, 4: Effect D,  
5: Effect E, 6: Effect F, 7: Effect G, 8: Effect H

- 3 Release the Performance Pad, or press it again.  
The effect turns off.

## ❖ Using Auto Loop

When you press a Performance Pad in Auto Loop mode, a loop with the number of beats assigned to the pad is set and the loop plays until you release the pad.

- 1 Press the **[B.JUMP]** mode button while holding the **[Shift]** button.  
The unit enters Auto Loop mode.
- 2 Press a Performance Pad during playback.  
Loop playback starts with the number of beats assigned to that pad.
  - When you press the same Performance Pad again, loop playback is canceled.

The pad's settings are as shown below.



1: 1/8 beat, 2: 1/4 beat, 3: 1/2 beat, 4: 1 beat,  
5: 2 beats, 6: 4 beats, 7: 8 beats, 8: 16 beats

## ❖ Using Key Shift

Key Shift is a function of the Pitch 'n Time DJ expansion pack.

- To use Pitch 'n Time DJ, you'll need to buy and activate it first.

For details, visit the website below.

[serato.com/dj/pro/expansions/pitchntimedj](http://serato.com/dj/pro/expansions/pitchntimedj)

When you press a Performance Pad in Key Shift mode, the key of the track that's currently playing is changed to the pitch set to the pressed pad.

- 1 Press the **[SAMPLER]** mode button while holding the **[Shift]** button.

The unit enters Key Shift mode.

The pad's settings are as shown below.



1: -4 Semitones, 2: -3 Semitones, 3: -2 Semitones, 4: -1 Semitone,  
5:  $\pm 0$  Semitones, 6: +1 Semitone, 7: +2 Semitones, 8: +3 Semitones

A semitone is a unit used to determine the pitch of a sound. +1 semitone means the sound is higher in pitch than the original sound by half.

- 2 Press a Performance Pad.

The track's key is changed to the pitch assigned to the pad.



## Using Stems FX

The Stem FX feature allows you to apply FX to specific Stems so that you can perform Stem mixes more creatively.

- Use the supplied overlay sheet.

### ❖ Selecting Stems

Press the **[VOCAL (DRUM SWAP 1)]**, **[MELODY (DRUM SWAP 2)]**, **[BASS (DRUM SWAP 3)]**, or **[DRUMS (DRUM SWAP 4)]** button.

It will be set for the Stem effects.

- You can select multiple Stems.
- The selected Stem's button will be lit.

### ❖ Applying the Roll effect to the selected Stem

**[STEMS ROLL (DRUM ROLL)]** buttons are set as shown below.

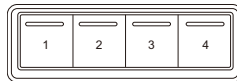

1: Roll (1/8 beat), 2: Roll (1/4 beat), 3: Roll (1/2 beat), 4: Roll (1 beat)

Press and hold down one of **[STEMS ROLL (DRUM ROLL)]** buttons. The Roll effect is applied to the selected Stem.

When you release the button, the effect will be cancelled.

### ❖ Using the Trans effect to the selected Stem

**[STEMS ROLL (DRUM ROLL)]** buttons are set as shown below.

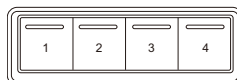

1: Trans (1/8 beat), 2: Trans (1/4 beat), 3: Trans (1/2 beat), 4: Trans (1 beat)

Press and hold down one of [**STEMS ROLL (DRUM ROLL)**] buttons while holding the [**Shift**] button.

The Trans effect is applied to the selected Stem.

When you release the button, the effect will be cancelled.

## ❖ Changing the operation mode for the Roll and Trans effects

Press the [**1/2 BEAT (CAPTURE)**] button while holding the [**Shift**] button.

The operation mode will be changed for the Roll and Trans effects.

- If the [**1/2 BEAT (CAPTURE)**] button is lit while holding the [**Shift**] button, the effect is continuously applied even after releasing the [**STEMS ROLL (DRUM ROLL)**] button.

When you press the [**STEMS ROLL (DRUM ROLL)**] button again, the effect will be cancelled.

- If the [**1/2 BEAT (CAPTURE)**] button isn't lit while holding the [**Shift**] button, the effect is applied while holding the [**STEMS ROLL (DRUM ROLL)**] button.

## ❖ Selecting an effect applied by the [**FX (DRUM RELEASE)**] lever

Set the Stems effect (Echo Out, Roll Out, Braker, or Delay) assigned to the [**FX (DRUM RELEASE)**] lever.

Press the [**VOCAL (DRUM SWAP 1)**], [**MELODY (DRUM SWAP 2)**], [**BASS (DRUM SWAP 3)**], or [**DRUMS (DRUM SWAP 4)**] button while holding the [**Shift**] button to select an effect.

The selected effect is assigned to the [**FX (DRUM RELEASE)**] lever and will affect selected Stems when triggered.

## ❖ Adjusting the Level/Depth of the effect assigned to the [**FX (DRUM RELEASE)**] lever

Turn the [**LEVEL/DEPTH (GAIN)**] knob.

You can adjust the parameters of the effect.

## ❖ **Setting the beats of the effect assigned to the [FX (DRUM RELEASE)] lever**

Press the **[1/2 BEAT (CAPTURE)]** button.

The number of beats of the effect will be changed.

- **[1/2 BEAT (CAPTURE)]** button is low lit: 1 beat is set.
- **[1/2 BEAT (CAPTURE)]** button lights up: 1/2 beat is set.

## ❖ **Applying the effect to the selected Stem using the [FX (DRUM RELEASE)] lever**

The effect is applied to Stems selected by the **[VOCAL (DRUM SWAP 1)]**, **[MELODY (DRUM SWAP 2)]**, **[BASS (DRUM SWAP 3)]**, or **[DRUMS (DRUM SWAP 4)]** button.

- 1 Tilt the **[FX (DRUM RELEASE)]** lever forward or backward.

The effect is applied to the Stem.

- To change the effect type, press the **[VOCAL (DRUM SWAP 1)]**, **[MELODY (DRUM SWAP 2)]**, **[BASS (DRUM SWAP 3)]**, or **[DRUMS (DRUM SWAP 4)]** button while holding the **[Shift]** button.
- To change the beat of the effect, press the **[1/2 BEAT (CAPTURE)]** button.
- To adjust the Level/Depth of the effect, turn the **[LEVEL/DEPTH (GAIN)]** knob.

- 2 Return the **[FX (DRUM RELEASE)]** lever to the center position to cancel the effect.

---

## Using Slip

If you turn Slip mode on, normal playback continues in the background while you're scratching or playing a loop or Hot Cue. When you stop scratching or playing the loop or Hot Cue, normal playback resumes from the position reached in the background.

- The **[SLIP]** button lights up when Slip mode is on, and flashes during playback in the background.

### ❖ Slip Scratch Play

- 1 Make sure Vinyl mode is turned on.  
Check that the **[SLIP]** button lights up while holding the **[Shift]** button.
  - For the default setting, Vinyl mode is on.
- 2 Press the **[SLIP]** button.  
The unit enters Slip mode.
- 3 To scratch the track, turn the top of the jog wheel during playback.  
Normal playback continues in the background while you're scratching.
- 4 Release the top of the jog wheel.  
Playback starts from the position reached in the background.
  - To cancel Slip mode, press the **[SLIP]** button again.

## ❖ Slip Hot Cue

- 1 Press the **[HOT CUE]** mode button.  
The unit enters Hot Cue mode.
- 2 Press a Performance Pad to set a Hot Cue.
- 3 Press the **[SLIP]** button.  
The unit enters Slip mode.
- 4 Press and hold a Performance Pad during playback.  
Playback starts from the Hot Cue point. While holding the pad, playback continues.  
Normal playback continues in the background during Hot Cue playback.
- 5 Release the Performance Pad.  
Playback starts from the position reached in the background.
  - To cancel Slip mode, press the **[SLIP]** button again.

## ❖ Slip Braking

- 1 Adjust the **[BRAKING]** - **[Stop Time]** setting in the **[DJ Preferences]** tab of the **[⚙️]** menu in Serato DJ Pro.  
With the **[BRAKING]** setting, you can adjust the speed at which a track slows down until it stops.  
When using Slip Braking, adjust the **[Stop Time]** knob of **[BRAKING]** to stop slowly.
- 2 Press the **[SLIP]** button.  
The unit enters Slip mode.
- 3 Press the **[▶/⏸ (play/pause)]** button during playback.  
Playback slows down gradually and stops. Normal playback continues in the background.

- 4 Press the **[▶/|| (play/pause)]** button again.

Playback starts from the position reached in the background.

- To cancel Slip mode, press the **[SLIP]** button again.

## ❖ Slip Auto Beat Loop

- 1 Press the **[SLIP]** button.

The unit enters Slip mode.

- 2 Press and hold down the **[IN]** button.

A 4-beat loop is set, and loop playback starts.

Normal playback continues in the background during loop playback.

- 3 Press the **[RELOOP/EXIT]** button.

The loop is canceled and playback starts from the position reached in the background.

- To cancel Slip mode, press the **[SLIP]** button again.

## ❖ Slip Manual Loop

- 1 Press the **[SLIP]** button.

The unit enters Slip mode.

- 2 Press the **[IN]** button, then press the **[OUT]** button.

Loop playback starts.

Normal playback continues in the background during loop playback.

- 3 Press the **[RELOOP/EXT]** button.

The loop is canceled and playback starts from the position reached in the background.

- To cancel Slip mode, press the **[SLIP]** button again.

---

## Using Fader Start

### ❖ Using Channel Fader Start

#### 1 Set the temporary cue point.

Pause the track at the position you want to start playback from, then press the **[CUE]** button on that deck.

#### 2 While holding the **[Shift]** button, move the channel fader from the bottom to the top.

Playback starts from the temporary cue point.

- If you move the channel fader back to the bottom while holding the **[Shift]** button during playback, the track instantly jumps back to the temporary cue point and playback pauses (Back Cue).

When no temporary cue point is set, playback starts from the beginning of the track.

### ❖ Using Crossfader Start

#### 1 Set the temporary cue point.

Pause the track at the position you want to start playback from, then press the **[CUE]** button on that deck.

#### 2 Move the crossfader all the way to the left or right side.

If you want to use Crossfader Start to trigger playback on channel 2, set the crossfader to the left side, and vice versa.

#### 3 While holding the **[Shift]** button, move the crossfader towards the opposite side from where it's set.

Playback starts from the temporary cue point.

- If you move the crossfader back while holding the **[Shift]** button during playback, the playback position instantly jumps back to the temporary cue point and pauses (Back Cue).

When no temporary cue point is set, playback starts from the beginning of the track.

## Using Dual Deck mode

You can simultaneously control Deck 1 and 3 (or Deck 2 and 4) in Dual Deck mode.

You can scratch or play a loop/Hot Cue, etc., as if the two different tracks of the two different decks are combined as one track.

- 1 Press the **[DECK 3]** button while holding the **[DECK 1]** button, or press the **[DECK 1]** button while holding the **[DECK 3]** button. The unit enters Dual Deck mode. The **[DECK]** button pressed first will flash, and the **[DECK]** button pressed next will light up.
  - When the unit enters Dual Deck mode, the deck status of the **[DECK]** button pressed first is displayed.
  - To cancel Dual Deck mode, press the **[DECK 1]** button or **[DECK 3]** button. The operating deck switches to the deck whose **[DECK]** button was pressed.

You can simultaneously control the following functions in Dual Deck mode with the relevant buttons and knobs in both decks.

Buttons/knobs	Functions
Jog wheel	Scratch, Pitch Bend
SLIP button	Slip mode, Vinyl mode
QUANTIZE button	Quantize function
MASTER TEMPO button	Key Lock
IN button	Loop in, Loop in adjust, 4 Beet Loop
OUT button	Loop out, Loop out adjust
RELOOP/EXIT button	Reloop/exit, Loop Active
CALL ◀ button	Loop half, Selecting a Loop Slot
CALL ▶ button	Loop double, Selecting a Loop Slot
MEMORY button	Saving/deleting a Loop Slot
HOT CUE mode button	Hot Cue mode, Keyboard mode



Buttons/knobs	Functions
STEMS mode button	Pad FX mode
B.JUMP mode button	Beat Jump mode, Beat Loop mode
SAMPLER mode button	Key Shift mode
Performance Pads	Pad modes of each pad (except for Stems mode and Sampler mode)
▶/   (play/pause) button	Playback/pause
CUE button	Cue settings, Back Cue, Cue Point Sampler
BEAT SYNC button	Sync on, Sync off
KEY SYNC button	Key Sync, Key Reset
GAIN knob	Level/Depth of the effect for Stem
DRUM SWAP button	Each Stem on/off, selecting an effect for Stem
CAPTURE button	Setting the beat of the effect for Stem
DRUM ROLL button	Roll, Trans
DRUM RELEASE button	Effects for Stem

You can control the following functions in Dual Deck mode with the relevant buttons and knobs on the deck with the flashing **[DECK]** button.

Buttons/knobs	Functions
TEMPO slider	Tempo adjustment
MASTER TEMPO button	Tempo range

- If the following modes are different in each deck, modes on the deck with the flashing **[DECK]** button will be used.
  - Vinyl mode
  - Pad mode

– Slip mode

---

## Analyzing tracks

Click the **[Analyze Files]** button in Serato DJ Pro to analyze tracks in your library that haven't been analyzed yet. You can also analyze the track by dragging and dropping it on the **[Analyze Files]** button.

- If a track is loaded to a deck before analysis is complete, it may take some time to display its BPM and waveform.
- Depending on the number of tracks, analysis may take some time.

## Using effects

- 1 Press the **[BEAT ◀]** button or **[BEAT ▶]** button while holding the **[Shift]** button.  
Select the BPM measurement mode.
  - **[AUTO]**: Press the **[BEAT ◀]** button while holding the **[Shift]** button. The BPM is automatically measured from the input audio signal.
  - **[TAP]**: Press the **[BEAT ▶]** button while holding the **[Shift]** button. Enter the BPM manually.
- 2 Turn the **[BEAT FX SELECT]** knob.  
Selects a type of effect in Serato DJ Pro.
- 3 Press the **[BEAT FX CH SELECT]** button.  
Selects a channel to apply the effect to.
  - **[1]** to **[4]**: Applies the effect to the sound of the respective channel.
  - **[SP]**: Applies the effect to the sampler sound.
  - **[MST]**: Applies the effect to the sound of the master channel.
  - Set **[Sample Player Output Select]** to **[A]** in Serato DJ Pro.
- 4 Press the **[BEAT ◀]** button or **[BEAT ▶]** button.  
Set the number of beats (or parameters) synchronized to the effect sound.
  - When set to 2 beats, **[1]** and **[4]** light up.
  - When set to more than 32 beats, **[32]** flashes.
  - When set to less than 1/4 beat, **[1/4]** flashes.
  - When the set number of beats is a minus number, the number flashes rapidly.
  - When Reverb and Pitch are selected, each indicator will light up as shown below.

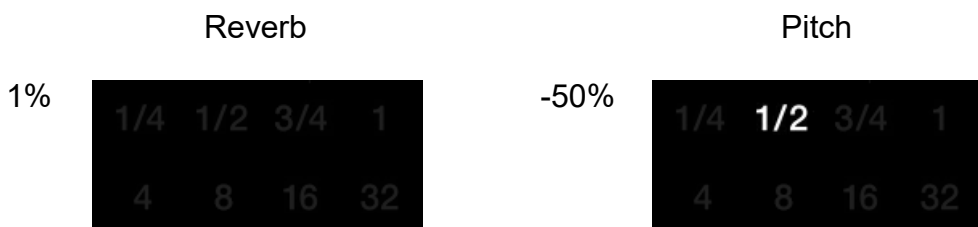

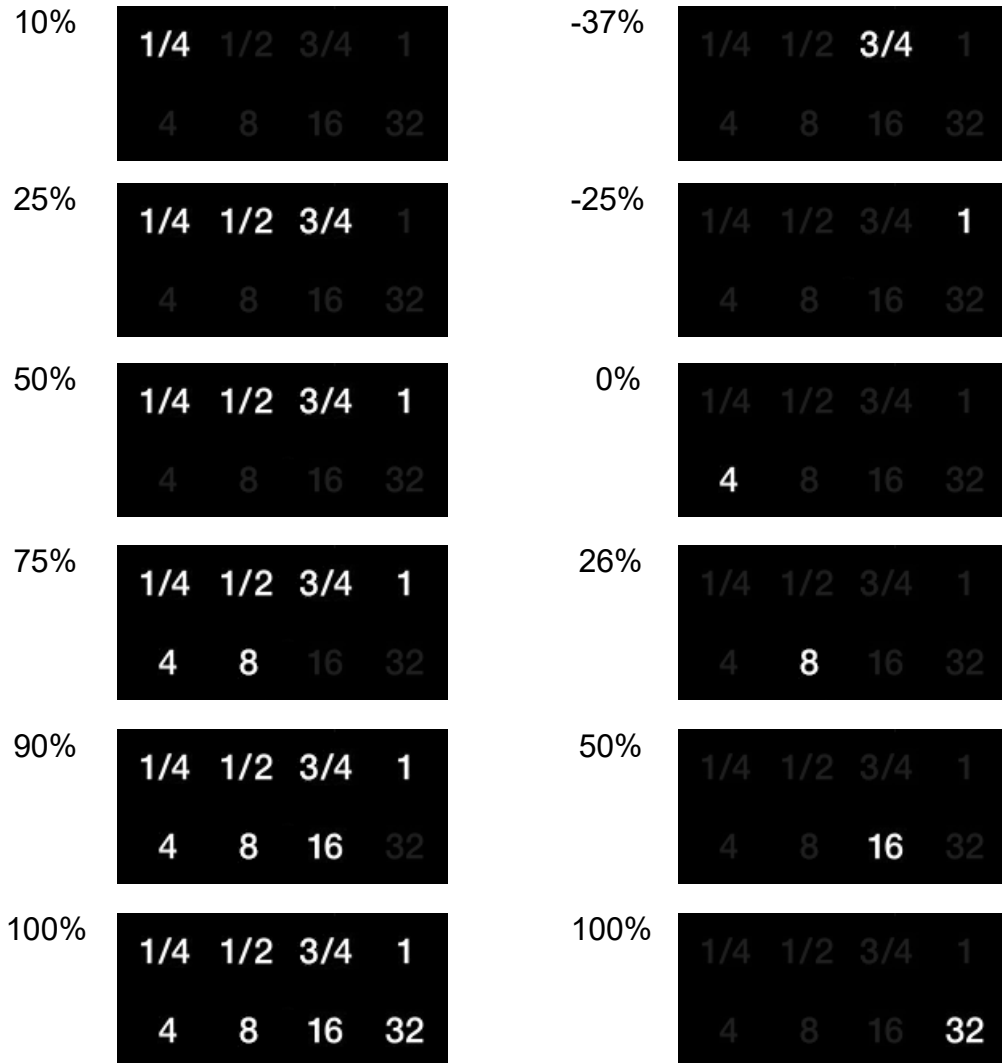

5 Press the **[BEAT FX ON/OFF]** button.

The effect is applied to the sound.

You can adjust the parameter of the effect by turning the **[BEAT FX LEVEL/DEPTH]** knob.

The **[BEAT FX ON/OFF]** button flashes when the effect is on.

- Press the **[BEAT FX ON/OFF]** button again to turn the effect off.

## Using a microphone

- 1 Connect a microphone to the **[MIC]** input terminal.
- 2 Turn the **[MIC LEVEL]** knob.  
Adjust the volume of the sound output from the **[MIC]** input terminal.
  - The sound comes out at a high volume if the knob is turned all the way to the right.
- 3 Talk into the microphone.
  - You can't add effects to the microphone sound on this unit.

---

---

# rekordbox for iOS/Android

---

---

## Installing rekordbox for iOS/Android

---

---

### Getting started with rekordbox for iOS/Android

If you're using rekordbox for iOS/Android for the first time, install the latest version.

If you already have rekordbox for iOS/Android installed, update to the latest version using App Store or Google Play.

- You are responsible for preparing your mobile device and other elements.

---

---

### Installing rekordbox for iOS/Android

Procedures may differ depending on the operating system (OS) of your mobile device.

#### ❖ Installing (iOS/iPadOS)

- 1 Scan the QR code or visit the URL below to open the App Store.



<https://apps.apple.com/app/id1487048203>

# rekordbox for iOS/Android

## 2 Install rekordbox for iOS.

When installation is finished, tap **[Open]** to start rekordbox for iOS.

## ❖ Installing (Android)

### 1 Scan the QR code or visit the URL below to open Google Play.



<https://play.google.com/store/apps/details?id=com.pioneerdj.rekordbox>

## 2 Install rekordbox for Android.

When installation is finished, tap **[Open]** to start rekordbox for Android.

## Basic use

---

### Starting rekordbox for iOS/Android

Tap the rekordbox icon.



**rekordbox**

rekordbox will ask for permission to access your mobile library (including music). Tap **[OK]**.

Read the terms of the license agreement carefully and if you agree to them, check **[I have read the above software use, license agreement]**, then tap **[Agree]**.

---

### Connecting your mobile device to the unit

#### ❖ Connecting with a USB cable

- 1 Connect your USB power adapter or mobile battery to the unit's USB port (for power supply) using a USB cable to turn the unit on.
- 2 Connect your mobile device to the unit's USB port (for device connection) using a USB cable.



## Loading an audio track onto a deck

The following explains how to load a track onto deck 1 (left) as an example.

- 1 Turn the smart rotary selector to select a track.

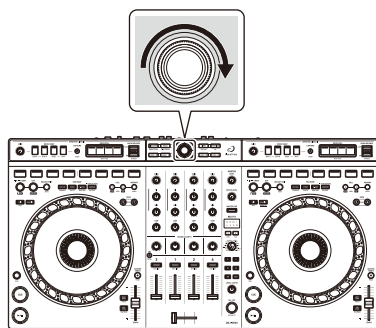

- Press the smart rotary selector to move the cursor to the next level down.

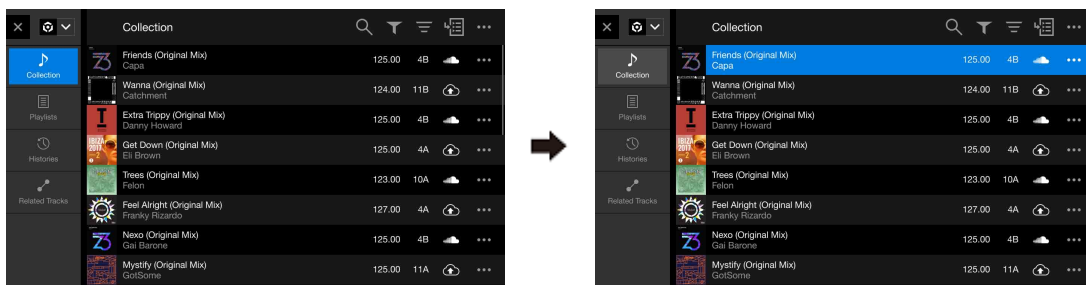

- Press the **[BACK]** button to move the cursor to the next level up.

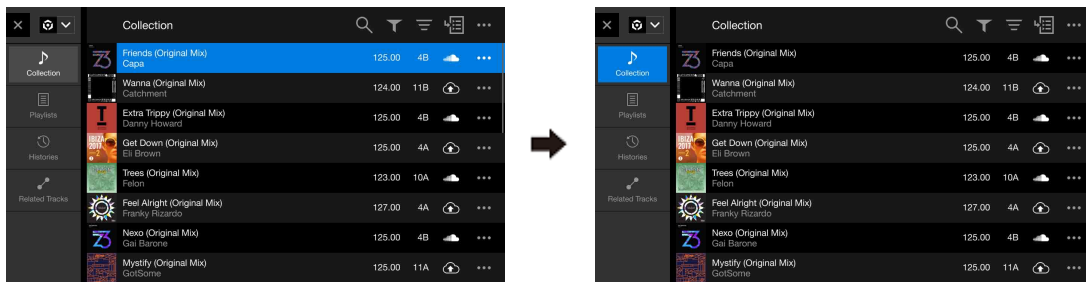

# rekordbox for iOS/Android

2 Press the [**LOAD 1**] button.

The track loads onto the deck.

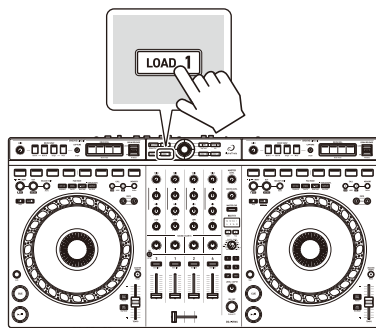

---

## Playing a track

This section explains how to play sound from deck 1 (left) as an example.

- 1 Set the positions of the knobs etc. as follows:
  - **[TRIM]** knob: turned fully counterclockwise
  - EQ **[HI/MID/LOW]** knobs: center position (12 o'clock)
  - **[SOUND COLOR FX]** knob: center position
  - Channel fader: bottom position
  - **[MASTER LEVEL]** knob: turned fully counterclockwise
  - Crossfader: center position
- 2 Press the **[▶/|| (play/pause)]** button to play the track.

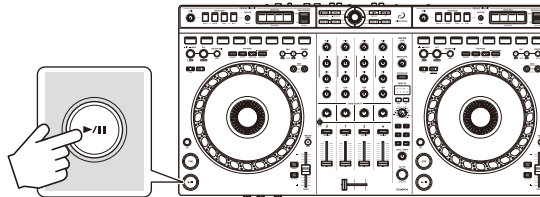

- 3 Turn the **[TRIM]** knob.  
Adjust the **[TRIM]** knob so the channel level indicator lights up orange at the loudest part of the track.

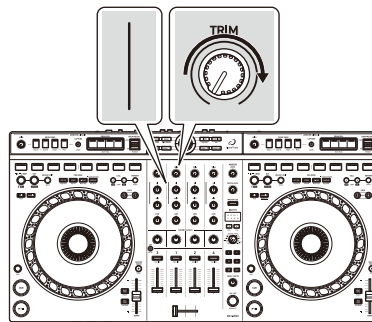

4 Move the channel fader to the top.

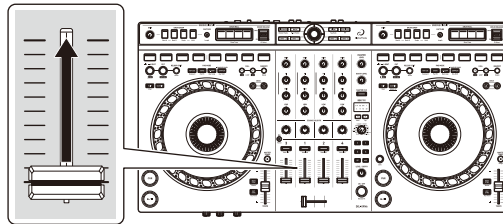

5 Adjust the volume of the speakers to a level you're happy with. Turn the **[MASTER LEVEL]** knob to adjust the volume of sound from the **[MASTER 1]** output terminals or **[MASTER 2]** output terminals.

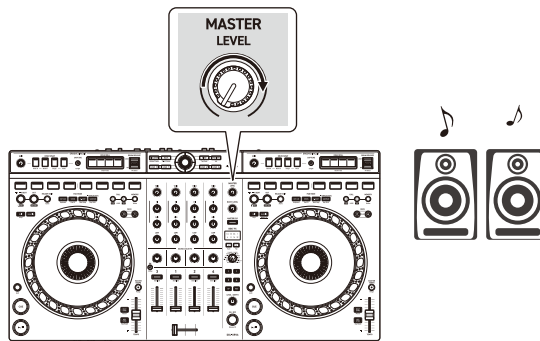

- If you can't output sound from the **[MASTER 1]** output terminals or **[MASTER 2]** output terminals or the unit isn't recognized by your mobile device, see: Troubleshooting (page 159).

---

## Monitoring with headphones when using a USB connection

When your mobile device is connected to the unit with a USB cable, you can monitor with headphones from the **[Ω (headphones)]** output terminal on the unit.

This section explains how to play sound from deck 1 (left) as an example.

- 1 Connect your headphones to the **[Ω (headphones)]** output terminal on the unit.
- 2 Set the positions of knobs etc. as shown below.
  - **[Ω (headphones) MIX]** knob: Center
  - **[Ω (headphones) LEVEL]** knob: Turned fully counterclockwise
- 3 Press the headphones **[CUE]** button for channel 1.
- 4 Turn the **[Ω (headphones) LEVEL]** knob.  
Adjust the headphones volume to a level you're happy with.

---

## If stereo sound doesn't output correctly

If your Android device is connected with a USB cable when **[Android MONO/STEREO]** is set to **[STEREO]**, it may not connect correctly and the stereo sound may not output normally. In this case, set **[Android MONO/STEREO]** to **[MONO]** on the rear panel.

---

## Turning off the unit

Disconnect the USB cable to turn off the unit.

---

---

## Advanced use

---

---

### Using 4 Beat Loop

While a track is playing, press and hold the **[IN]** button.

Loop playback starts with 4 beats from the point where you press the button.

- When the Quantize function is turned on, you might notice a slight delay as the loop synchronizes to the beat.

#### ❖ Canceling loop playback

Press the **[RELOOP/EXIT]** button.

When the loop out point is reached, the rest of the track continues to play without returning to the loop in point.

---

### Using Manual Loop

You can use Manual Loop to choose the section you want to loop in a track.

- When the Quantize function is turned on, you might notice a slight delay as the loop synchronizes to the beat.
- 1 During playback, press the **[IN]** button at the point you want to start looping (the loop in point).
  - 2 Press the **[OUT]** button at the point you want the loop to end (the loop out point).  
Loop playback starts.

## ❖ Cutting the loop

Press the **[CALL ◀]** button.

Each time you press the button, the loop cuts in half.

- You can cut the loop length in half even during 4 Beat Loop playback.

## ❖ Extending the loop

Press the **[CALL ▶]** button.

Each time you press the button, the loop doubles in length.

- You can double the loop length even during 4 Beat Loop playback.

## ❖ Canceling a loop

Press the **[RELOOP/EXIT]** button.

The rest of the track continues to play without returning to the loop in point.

## ❖ Changing the loop in point

Press the **[IN]** button and turn the jog wheel during loop playback.

The loop in point changes.

## ❖ Changing the loop out point

Press the **[OUT]** button and turn the jog wheel during loop playback.

The loop out point changes.

## Using the Performance Pads

The Performance Pad's settings are as shown below.



### ❖ Using Hot Cues

You can start playback instantly from the position where a Hot Cue is set. Loops can also be set and called up instantly.

- Up to 8 Hot Cues can be set and saved for each track in rekordbox for iOS/Android.

### Setting and calling up a Hot Cue

- 1 Press the **[HOT CUE]** mode button.

The unit enters Hot Cue mode.

- 2 When the track is playing or paused, press a Performance Pad to set a Hot Cue.

Hot Cues are set to Performance Pads as follows:

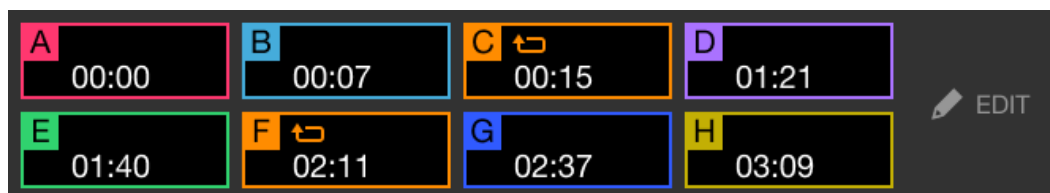

- 3 Press a Performance Pad you've set a Hot Cue for.

Playback starts from the Hot Cue point.

- You can clear Hot Cues by pressing a Performance Pad while holding the **[Shift]** button.



## Setting and calling up 4 Beat Loop

- 1 Press the **[HOT CUE]** mode button.  
The unit enters Hot Cue mode.
- 2 Press and hold the **[IN]** button during playback.  
A loop with 4 beats is set at the position where you pressed the button, and loop playback starts.
- 3 Press a Performance Pad to set a loop during loop playback.
- 4 Press the Performance Pad.  
Loop playback starts from the loop in point.
  - You can clear the loop by pressing the Performance Pad while holding the **[Shift]** button.

## Setting and calling up Manual Loop

- 1 Press the **[HOT CUE]** mode button.  
The unit enters Hot Cue mode.
- 2 Press the **[IN]** button during playback, and press the **[OUT]** button.  
Loop playback starts.
- 3 Press a Performance Pad to set a loop during the loop playback.
- 4 Press the Performance Pad.  
Loop playback starts from the loop in point.
  - You can clear the loop by pressing the Performance Pad while holding the **[Shift]** button.

## ❖ Using Pad FX

You can add a wide range of effects to your performances simply by pressing and releasing the Performance Pads.

1 Turn on Pad FX mode 1 or Pad FX mode 2.

- Pad FX mode 1: Press the **[STEMS]** mode button.
- Pad FX mode 2: Press the **[STEMS]** mode button while holding the **[Shift]** button.

When switching between Pad FX mode 1 and Pad FX mode 2, effects set to the Performance Pads are changed.

Pad FX mode 1

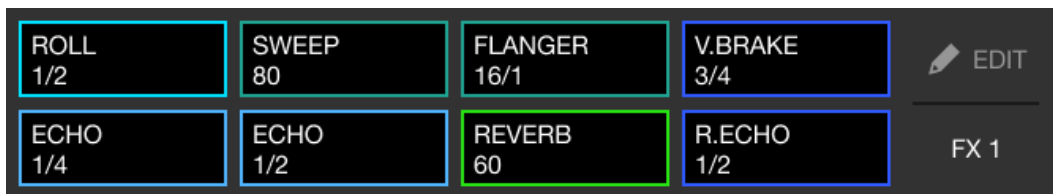

Pad FX mode 2



2 Press and hold down a Performance Pad.

The effect turns on. The sound changes according to the type of effect and the number of beats assigned to that pad.

3 Release the Performance Pad.

The effect turns off.

## Using Release FX of Pad FX

You need to assign a Release FX to a Performance Pad in advance.

- 1 Press and hold down a Performance Pad that has an effect other than a Release FX assigned to it.  
The effect turns on. The sound changes according to the type of effect and the number of beats in the settings assigned to that pad.
- 2 Press the Performance Pad that has a Release FX assigned to it, and release it.  
The effect turns off, and the Release FX is added.

## ❖ Using Beat Jump

You can move the playback position instantly, without breaking the rhythm of the track that's playing.

- 1 Press the **[B.JUMP]** mode button.  
The unit enters Beat Jump mode.  
The number and direction of beats set to the Performance Pads are as follows (default):

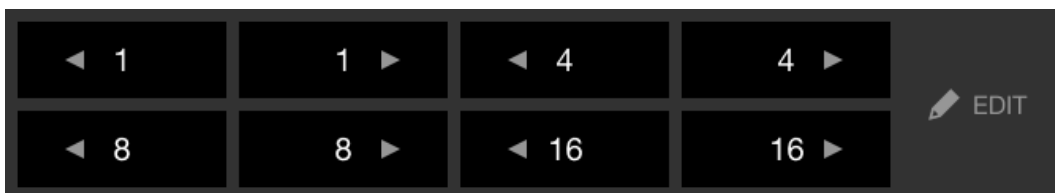

- 2 Press a Performance Pad.  
The playback position is moved by the number and direction of beats set on the pad.

## ❖ Using Sampler

You can use the Performance Pads to play tracks or sounds assigned to the Sampler slots.

- 1 Press the **[SAMPLER]** mode button.  
The unit enters Sampler mode.
- 2 Adjust the sampler volume.

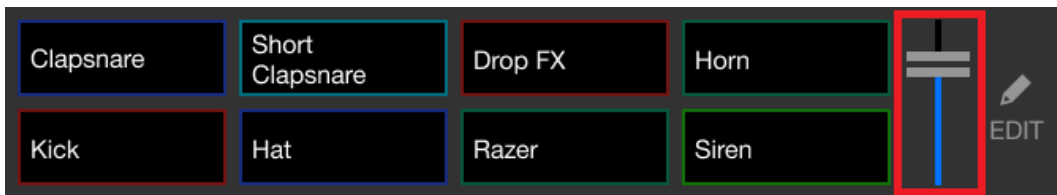

- 3 Press a Performance Pad.

The track or sound assigned to the relevant slot is played.

- Samplers set to the Performance Pads on deck 1 and deck 2 are different (default).



- 4 During Sampler playback, press the Performance Pad again.  
The sound plays from the beginning again.

- 5 Press a Performance Pad while holding the **[Shift]** button during Sampler playback.  
The sound of the slot that is currently playing stops.

## ❖ Using Keyboard mode

Use Performance Pads to play a Hot Cue in different pitches, as if you're using a keyboard.

1 Press the **[HOT CUE]** mode button while holding the **[Shift]** button. The unit enters Keyboard mode.

2 Press a Performance Pad.

Select the Hot Cue you want to use with Keyboard mode.

- If no Hot Cue is set, the current playback position is set as a Hot Cue. After selecting the Hot Cue which you set, the Hot Cue is used with Keyboard mode.
- To reselect a Hot Cue, press the **[HOT CUE]** mode button while holding the **[Shift]** button.

When the Hot Cue is selected, the various pitches are set to the Performance Pads as follows (Default):



The number displayed on each pad shows the semitones number.

Example) +4: +4 Semitones

A semitone is a unit used to determine the pitch of a sound. +1 semitone means the sound is higher in pitch than the original sound by half.

3 Press a Performance Pad.

Playback starts from the Hot Cue point, with the sound pitch assigned to that pad.

- You can clear Hot Cues by pressing a Performance Pad while holding the **[Shift]** button.

## ❖ Using Beat Loop

If you press a Performance Pad, a loop with the number of beats assigned to the pad is set. The loop keeps playing after you remove your finger from the pad.

- 1 Press the **[B.JUMP]** mode button while holding the **[Shift]** button. The unit enters Beat Loop mode.

The number of beats set to the Performance Pads are as follows (default):

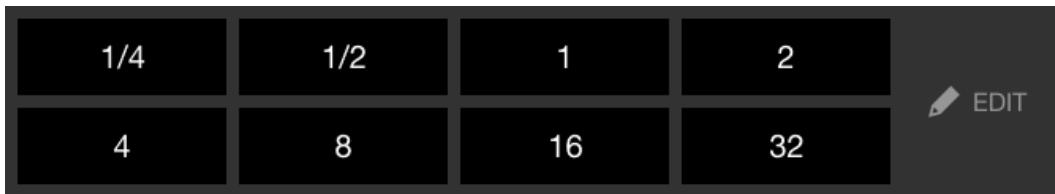

The number displayed on each pad shows the number of beats for loop playback.

- 2 Press a Performance Pad. The loop plays with the number of beats set on that pad.
- 3 Press the same Performance Pad again. The loop is canceled and the rest of the track continues to play.

## ❖ Using Key Shift

When you press a Performance Pad in Key Shift mode, the key of the track that's currently playing is changed to the pitch set to the pressed pad.

- 1 Press the **[SAMPLER]** mode button while holding the **[Shift]** button.

The unit enters Key Shift mode.

The various pitches are set to the Performance Pads as follows (Default):



The number displayed on each pad shows the semitones number.

Example) +4: +4 Semitones

A semitone is a unit used to determine the pitch of a sound. +1 semitone means the sound is higher in pitch than the original sound by half.

- 2 Press a Performance Pad.

The track's key is changed to the pitch assigned to the pad.

## Setting and calling up a cue point or loop point

### ❖ Setting a cue point or loop point

- 1 Pause the track and move the playback position to where you want to set a cue point or loop point.
- 2 Press the **[CUE]** button while the track is paused.
- 3 Press the **[MEMORY]** button.  
The cue point or loop point is saved.

### ❖ Calling up the cue point or loop point

Press the **[CALL ►]** button or **[CALL ◀]** button.  
The cue point or loop point is called up.

### ❖ Deleting the cue point or loop point

- 1 Press the **[CALL ►]** button or **[CALL ◀]** button.  
The cue point or loop point is called up.
- 2 Press the **[MEMORY]** button while holding the **[Shift]** button.  
The cue point or loop point is deleted.



## Using Slip

If you turn Slip mode on, normal playback continues in the background while you scratch, play a loop, or play a Hot Cue. When you stop scratching or playing the loop or Hot Cue, normal playback resumes from the position reached in the background.

- The **[SLIP]** button lights up when Slip mode is on, and flashes during playback in the background.

### ❖ Slip Scratch Play

- 1 Make sure Vinyl mode is turned on.  
Check that the **[SLIP]** button lights up while holding the **[Shift]** button.
  - For the default setting, Vinyl mode is on.
- 2 Press the **[SLIP]** button.  
The unit enters Slip mode.
- 3 To scratch the track, turn the top of the jog wheel during playback.  
Normal playback continues in the background while you're scratching.
- 4 Release the top of the jog wheel.  
Playback starts from the position reached in the background.
  - To cancel Slip mode, press the **[SLIP]** button again.

### ❖ Slip Hot Cue

- 1 Press the **[HOT CUE]** mode button.  
The unit enters Hot Cue mode.
- 2 Press the Performance Pad to set the Hot Cue.
- 3 Press the **[SLIP]** button.  
The unit enters Slip mode.

- 4 Press and hold a Performance Pad during playback.  
Playback starts from the Hot Cue point. While holding the pad, playback continues.  
Normal playback continues in the background during Hot Cue playback.
- 5 Release the Performance Pad.  
Playback starts from the position reached in the background.
  - To cancel Slip mode, press the **[SLIP]** button again.

## ❖ Slip Braking

- 1 Turn your mobile device into landscape mode, and adjust the **[Stop Time]** setting in the **[Settings] > [General]** in rekordbox for iOS/Android.  
With the **[Stop Time]** setting, you can adjust the speed at which a track slows down until it stops.  
When using Slip Braking, adjust **[Stop Time]** to stop slowly.
- 2 Press the **[SLIP]** button.  
The unit enters Slip mode.
- 3 Press the **[▶/|| (play/pause)]** button during playback.  
Playback slows down gradually and stops. Normal playback continues in the background.
- 4 Press the **[▶/|| (play/pause)]** button again.  
Playback starts from the position reached in the background.
  - To cancel Slip mode, press the **[SLIP]** button again.

## ❖ Slip Auto Beat Loop

- 1 Press the **[SLIP]** button.  
The unit enters Slip mode.
- 2 Press the **[IN]** button.  
A 4-beat loop is set, and loop playback starts.  
Normal playback continues in the background during loop playback.
- 3 Press the **[RELOOP/EXIT]** button.  
The loop is canceled and playback starts from the position reached in the background.
  - To cancel Slip mode, press the **[SLIP]** button again.

## ❖ Slip Manual Loop

- 1 Press the **[SLIP]** button.  
The unit enters Slip mode.
- 2 Press the **[IN]** button, then press the **[OUT]** button.  
Loop playback starts.  
Normal playback continues in the background during loop playback.
- 3 Press the **[RELOOP/EXIT]** button.  
The loop is canceled and playback resumes from the position reached in the background.
  - To cancel Slip mode, press the **[SLIP]** button again.

## Using Fader Start

### ❖ Using Channel Fader Start

- 1 Set the cue point.

Pause the track at the position you want to start playback from, then press the **[CUE]** button on that deck.

- 2 While holding the **[Shift]** button, move the channel fader from the bottom to the top.

Playback starts from the cue point.

- If you move the channel fader back to the bottom while holding the **[Shift]** button during playback, the track instantly jumps back to the cue point and playback pauses. (Back Cue)

When no cue point is set, playback starts from the beginning of the track.

### ❖ Using Crossfader Start

- 1 Set the cue point.

Pause the track at the position you want to start playback from, then press the **[CUE]** button on that deck.

- 2 Move the crossfader all the way to the left or right side.

If you want to use Crossfader Start to trigger playback on channel 2, set the crossfader to the left side, and vice versa.

- 3 While holding the **[Shift]** button, move the crossfader towards the opposite side from where it's set.

Playback starts from the cue point.

- If you move the crossfader back while holding the **[Shift]** button during playback, the playback position instantly jumps back to the cue point and pauses. (Back Cue)

When no cue point is set, playback starts from the beginning of the track.

---

## Analyzing tracks

Set **[Settings]** > **[General]** > **[Track Analysis]** > **[Auto Analysis]** on to start track analysis.

- If a track is loaded to a deck before analysis is complete, it may take some time to display its BPM and waveform.
- Depending on the number of tracks, analysis may take some time.

---

## Using Beat FX

You can apply effects that match the tempo (BPM) of the track loaded on the deck.

- 1 Press the **[BEAT ◀]** button or **[BEAT ▶]** button while holding the **[Shift]** button.  
Selects the BPM measurement mode.
  - **[AUTO]**: Press the **[BEAT ◀]** button while holding the **[Shift]** button. The BPM is automatically measured from the input audio signal.
  - **[TAP]**: Press the **[BEAT ▶]** button while holding the **[Shift]** button. You can now enter the BPM manually by tapping the **[TAP]** button.
- 2 Turn the **[BEAT FX SELECT]** knob.  
Selects a type of effect.
- 3 Press the **[BEAT FX CH SELECT]** button.  
Selects a channel to apply the effect to.
  - **[1]**: Applies the effect to the sound of the channel 1.
  - **[2]**: Applies the effect to the sound of the channel 2.
  - **[MST]**: Applies the effect to the sound of the channel 1 and channel 2.
  - **[3], [4], [SP]**: Not used

- 4 Press the **[BEAT ◀]** button or **[BEAT ▶]** button.  
Sets the number of beats synchronized to the effect sound.  
The effect time corresponding to the number of beats is set automatically.
- 5 Press the **[BEAT FX ON/OFF]** button.  
The effect is applied to the sound.  
You can adjust the effect's parameter by turning the **[BEAT FX LEVEL/DEPTH]** knob.  
The **[BEAT FX ON/OFF]** button flashes when the effect is on.
  - Press the **[BEAT FX ON/OFF]** button again to turn the effect off.

---

## Using a microphone

- 1 Connect a microphone to the **[MIC]** input terminal.
- 2 Turn the **[MIC LEVEL]** knob.  
Adjust the volume of the sound output from the **[MIC]** input terminal.
  - The sound comes out at a high volume if the knob is turned all the way to the right.
- 3 Talk into the microphone.
  - You can't add effects to the microphone sound on this unit.

## Changing the settings in rekordbox for iOS/Android

You can change the settings of the unit in rekordbox for iOS/Android under **[DDJ-GRV6]** in **[Settings]**.

When you connect the unit to rekordbox for iOS/Android, you can change the following settings:

### **[BACK SPIN LENGTH]** setting

When using the Back Spin feature with the jog wheel, the length of the Back Spin is different from the length of the jog wheel rotation.

You can choose the length of the Back Spin from 3 options: short, normal, or long.

- **[short]**: Back Spin length short
- **[normal]**: Back Spin length normal
- **[long]**: Back Spin length long

### **[Slip Mode Flashing]** setting

Set Slip Mode Flashing.

- **[Enable]**: When Slip mode is on, the buttons that can work in Slip mode will flash.
- **[Disable]**: When Slip mode is on, the buttons that can work in Slip mode won't flash.

### **[Lighting Operation of Slip button]** setting

Set the lighting operation of the **[SLIP]** button when Slip mode is on.

- **[Light is On]**: When Slip mode is on, the **[SLIP]** button lights, and the button flashes during slip operation.
- **[Blink]**: When Slip mode is on, the **[SLIP]** button always flashes.

### **[Fader Start]** setting

Change the setting of the Fader Start function.

## **[CROSSFADER] > [Cut Lag] setting**

Adjust the Cut Lag on both edges of the crossfader.

Units of 0.1 mm can be adjusted from 0.3 mm to 5.5 mm.

- The default Cut Lag is 1.0 mm.
- This Cut Lag setting is a guide, and may not be exact.

## **[MIC Output of Booth] setting**

Set the microphone sound to be output to the Booth output or not.

- **[ON]**: The microphones sound outputs to the Booth output and mixed.
- **[OFF]**: The microphones sound doesn't output to the Booth output.

## **[Headphone output] setting**

Change the output sound from the **[🎧 (headphones)]** output terminals.

- **[STEREO]**: Outputs the monitor sound in stereo.
- **[MONO SPLIT]**: Outputs the monitor sound other than the master sound from the left channel and the monitor sound of the master sound from the right channel.

## **[Demo mode] setting**

Set the time to pass before Demo mode starts.

The default setting is **[10 minutes]**.

To cancel Demo mode, operate any knob or button on the unit.

- **[1 minute]**: Demo mode starts when there is no operation on the unit for 1 minute.
- **[5 minutes]**: Demo mode starts when there is no operation on the unit for 5 minutes.
- **[10 minutes]**: Demo mode starts when there is no operation on the unit for 10 minutes.
- **[Off]**: Demo mode never starts.



## **[Power Management]** setting

When the Power Management function is set to **[Enable]**, the unit enters Off mode automatically after 20 minutes if the unit is not operated without audio signal input to each channel.

During Off mode, the **[QUANTIZE]** button in the right deck is lit. To cancel Off mode, press the **[QUANTIZE]** button.

- The default setting of the Power management function is **[Enable]**.
- To cancel the Power Management function, set to **[Disable]**.
- If the Power Management function is set to **[Disable]**, power consumption may increase.

---

---

# Changing the settings

---

---

## Launching Utilities mode

Be sure to close your DJ application and then launch Utilities mode.

To use Utilities mode when connected to rekordbox for Mac/Windows or rekordbox for iOS/Android, set it on the preferences screen in rekordbox for Mac/Windows or rekordbox for iOS/Android.

➡ Read: Changing the settings in rekordbox for Mac/Windows (page 92)

➡ Read: Changing the settings in rekordbox for iOS/Android (page 151)

- 1 Disconnect the USB cable.
- 2 Hold both the **[Shift]** and **[▶/|| (play/pause)]** buttons on the left deck and connect the USB cable.  
Utilities mode launches.
- 3 Change the settings.  
When you change the settings, they will be saved. While saving, the **[BEAT FX ON/OFF]** button flashes. If you disconnect the USB cable while the pads are flashing, settings may not be saved.
- 4 Disconnect the USB cable to turn off the unit.  
Utilities mode turns off.

## Utilities mode settings

You can change the following settings in Utilities mode:

- Back Spin Length
- Slip Mode Flashing
- Slip button LED status while slip mode is on
- Fader Start
- Crossfader Cut Lag
- MIC Output of Booth
- Headphones output
- Mix the MIC audio to REC OUT
- Demo mode
- Power Management

### ❖ Back Spin Length

When using a jog wheel to perform a Back Spin, you can make the Back Spin longer or shorter than the amount you rotate the jog wheel by.

You can set the Back Spin Length to short, normal, or long.

Press one of the Performance Pads 1 through 3 on the left deck.

- Pad 1 is lit: Back Spin Length short
- Pad 2 is lit: Back Spin Length normal (Default)
- Pad 3 is lit: Back Spin Length long

### ❖ Slip Mode Flashing

Flashes the related controls.

Press the **[SLIP]** button on the left deck.

- **[SLIP]** button is lit: Slip Mode Flashing is turned on.
- **[SLIP]** button is not lit: Slip Mode Flashing is turned off.

# Changing the settings

## ❖ **Slip button LED status while slip mode is on**

Sets the LED status of the **[SLIP]** button in Slip mode.

Press the **[SLIP]** button on the right deck.

- **[SLIP]** button is lit: The LED is lit when Slip mode is turned on. The LED flashes during Slip operation.
- **[SLIP]** button is not lit: The LED always flashes in Slip mode.

## ❖ **Fader Start**

Press the **[HOT CUE]** mode button, **[STEMS]** mode button, or **[B.JUMP]** mode button on the left deck.

- **[HOT CUE]** mode button is lit: Fader Start with Sync setting is turned on. (When Fader Start starts the Sync feature will be activated.)
- **[STEMS]** mode button is lit: Fader Start without Sync setting is turned on. (When Fader Start starts the Sync feature won't be activated.)
- **[B.JUMP]** mode button is lit: Fader Start is turned off.

## ❖ **Crossfader Cut Lag**

You can adjust the cut lag (the range where no sound is heard from the relevant deck) at both edges of the crossfader.

You can make adjustments in increments of 0.1 mm within a range of 0.3 mm to 5.5 mm. (Setting value: 1 through 53)

- The setting amount for the Cut Lag is a guide, and may not be exact.
- The default Cut Lag amount is 1.0 mm. (Setting value: 8)

Turn the smart rotary selector.

The number of lights that are lit up on the channel level indicators indicates the setting value (1 through 53).

- The number of lights that are lit up on the channel level indicators on channel 1: tens place.
- The sum of the number of lights that are lit up on the channel level indicators on channel 2 and 4: ones place.

E.g. 2 lights on channel 1, plus 3 lights on channel 2, plus 5 lights on channel 4 means the total value is 28 (20 + 3 + 5 = 28).

## ❖ MIC Output of Booth

Press the Performance Pad 6 on the left deck.

- Pad 6 is lit: The microphone sound outputs from the **[BOOTH]** output terminals (Default).
- Pad 6 is not lit: The microphone sound doesn't output from the **[BOOTH]** output terminals.

## ❖ Headphones output

Select the monitor sound output from the headphones.

Press the Performance Pad 7 on the left deck.

- Pad 7 is lit: The sound of the channel selected with the headphones **[CUE]** button will be output in stereo from the **[⌂ (headphones)]** output terminals.
- Pad 7 is not lit: The sound of the channel selected with the headphones **[CUE]** button other than the master channel is output from the left channel. The master audio is output from the right channel.

## ❖ Mix the MIC audio to REC OUT

Press the Performance Pad 8 on the left deck.

- Pad 8 is lit: The microphones sound is mixed to REC OUT (Default).
- Pad 8 is not lit: The microphones sound isn't mixed to REC OUT.

## ❖ Demo mode

In normal conditions, if you don't use any features for a specified amount of time, the unit will enter Demo mode.

- When any knob or button on the unit is used during Demo mode, Demo mode is canceled.

Press one of the Performance Pads 1 through 4 on the right deck.

- Pad 1 is lit: Demo mode is switched off.
- Pad 2 is lit: Demo mode starts when you don't use the unit for 1 minute.
- Pad 3 is lit: Demo mode starts when you don't use the unit for 5 minutes.
- Pad 4 is lit: Demo mode starts when you don't use the unit for 10 minutes. (Default)

## ❖ Power Management

When Power Management function is set to on, the unit enters Off mode automatically after 20 minutes without being used (no audio signal is input to the unit).

In Off mode, the **[QUANTIZE]** button on the right deck is lit.

Press the lit **[QUANTIZE]** button to cancel Off mode.

- Turn the Power Management function off if you don't need to use the feature.
- If you turn the Power Management function off, the power consumption may increase.

Press the **[QUANTIZE]** button on the right deck.

- **[QUANTIZE]** button is lit: the Power Management function is turned on (Default).
- **[QUANTIZE]** button is not lit: the Power Management function is turned off.

---

---

# Additional information

---

---

## Troubleshooting

If you think something is wrong with the unit, check the information below and refer to the **[FAQ]** for the DDJ-GRV6 on the AlphaTheta website.

[alphatheta.com/support/](http://alphatheta.com/support/)

Sometimes, the problem may be caused by another device. Inspect the other devices and electrical appliances you're using and refer to their manuals and FAQ if necessary. If the problems continue, read the Precautions for Use and consult an authorized service company or your dealer.

- The unit may not work properly if it's subjected to static electricity or other external influences. In this case, turn the unit off and on again to restore proper operation.

---

---

## Power

### ❖ The unit does not power up.

- Connect the USB power adapter (or mobile battery) and USB cable correctly. See: Connections (page 54)
- Change the USB power adapter (or mobile battery) or USB cable.

### ❖ The unit powers down unexpectedly.

- Use a mobile battery which does not have a power-saving function. The maximum voltage is 24V or less and DC 9V 3A for the mobile battery.  
Use a USB cable certified to the appropriate standard.

## Additional information

- When the Power Management function is set to **[Enable]**, this unit automatically enters Off mode after 20 minutes without being used (no audio signal is input to the unit). See: Power Management Function (page 94) (page 153) (page 158).
- ❖ **The [IN] button and [OUT] button on both decks flash and don't work.**
  - The supply capacity of the USB power adapter or mobile battery connected to the unit's USB port (for power supply) may be insufficient. Use a device with DC 9V 3A.
- ❖ **Red indicators of the channel 1, 2, 3, and 4 level indicators flash and don't work.**
  - The supply capacity of the PC/Mac connected to the unit's USB port (for power supply) may be insufficient.
  - If you connect the unit to the USB (Type-C) port of the PC/Mac, connect the PC/Mac to an AC power supply. If other USB devices are connected to your PC/Mac, the power supply capacity to this unit may be insufficient.
  - If you connect the unit to the USB (Type-A) port of the PC/Mac, connect the USB power adapter or mobile battery with the maximum voltage 24V or less and DC 9V 3A to the unit's USB port (for power supply). See: Connections (page 54).



---

## Connection

### ❖ **The unit isn't recognized by your PC/Mac.**

- Connect the supplied USB cable correctly. See: Connections (page 54)
- When using a USB hub, be sure it's a product recommended by the manufacturer of your PC/Mac.
- Quit any other open applications including screen savers and antivirus security software on your PC/Mac. (When quitting antivirus security software, before doing so, disable the internet connection to ensure the security of your PC/Mac.)
- Disconnect any external hard disk, keyboard, etc. Use the internal hard disk only.
- If your PC/Mac has multiple USB ports, try connecting to another one.
- For Mac, launch the macOS utility software **[Audio MIDI Setup]**, and click **[Windows]** on the menu bar and check that > **[Show Audio Devices]** > **[DDJ-GRV6 Audio Out]** is displayed.
- For Mac, the sound setting may not be correct. Disconnect the USB cable, launch the macOS utility software **[Audio MIDI Setup]**, and display **[MIDI Window]** or **[MIDI Studio]**. Select the **[DDJ-GRV6]** icon, and click **[Remove Device]**. (The icon may be **[USB MIDI Device]** instead of **[DDJ-GRV6]**. In this case, select **[USB MIDI Device]**.) Connect the unit with the USB cable again. The **[DDJ-GRV6]** icon is displayed.
- For Windows, check that **[DDJ-GRV6]** is displayed under **[Device Manager]** > **[Sound, video and game controllers]**.

### ❖ **When using a USB connection, the unit isn't recognized by a mobile device.**

- Connect the USB power adapter (or mobile battery) and USB cable correctly. See: Connections (page 54).

- Change the USB power adapter (or mobile battery) or USB cable.

---

### Sound

#### ❖ **Sound isn't output, is too quiet, or is distorted.**

- Set the **[TRIM]** knob, channel fader, crossfader, and **[MASTER LEVEL]** knob to the correct positions. See: Playing a track (page 65) (page 102)
- Connect the connection cable properly. See: Connections (page 54)
- Clean the terminals and plugs before connecting the cable to the unit.
- If sound is distorted, change the buffer size for your DJ software.

#### ❖ **Microphone sound can't be output.**

- Set the **[MIC ATT.]** knob and **[MIC LEVEL]** knob to the correct position (page 91)(page 125).

---

### rekordbox for Mac/Windows

#### ❖ **rekordbox becomes unstable.**

- Update rekordbox to the latest version. See: Installing rekordbox for Mac/Windows (page 59)
- Quit any other applications on your PC/Mac. If rekordbox remains unstable, try disabling the wireless network or other wireless connections, antivirus software, screen saver, low-power mode, etc. (When quitting antivirus security software, before doing so, disable the internet connection to ensure the security of your PC/Mac.)
- If another USB device is connected to your PC/Mac, disconnect it.
- When using a USB hub, be sure it's a product recommended by the manufacturer of your PC/Mac.
- If you're using battery power for your laptop, connect the laptop to an AC power supply.

### ❖ **BPM and beatgrid are not displayed correctly./Beatgrid is misaligned.**

- Change the BPM analysis range and analyze the track again. If it doesn't work, manually set the beatgrid and BPM.
- Adjust the beatgrid. For details on how to adjust the beatgrid, see the rekordbox Instruction Manual.

### ❖ **Sound is interrupted while using rekordbox for Mac/Windows.**

- Set the buffer size in **[Preferences] > [Audio]** in rekordbox for Mac/Windows.

### ❖ **Fader Start doesn't work.**

- Set a cue.
- To activate Fader Start, mark the **[Fader Start]** check box in **[Preferences] > [Controller] > [Mixer]** in rekordbox for Mac/Windows.

## Serato DJ Pro

### ❖ Serato DJ Pro becomes unstable.

- Update Serato DJ Pro to the latest version. See: Installing Serato DJ Pro (page 95)
- Quit any other applications on your PC/Mac. If Serato DJ Pro remains unstable, try disabling the wireless network or other wireless connections, antivirus software, screen saver, low-power mode, etc. (When quitting antivirus security software, before doing so, disable the internet connection to ensure the security of your PC/Mac.)
- If another USB device is connected to your PC/Mac, disconnect it.
- When using a USB hub, be sure it's a product recommended by the manufacturer of your PC/Mac.
- If you're using battery power for your laptop, connect the laptop to an AC power supply.

### ❖ Tracks aren't displayed in the library.

- Import music files. For details about importing music files (tracks), see: Importing music files (tracks) (page 100)
- If you selected a crate or subcrate which doesn't contain any tracks, select another crate or subcrate which does contain tracks, or import tracks into the crate or subcrate.

### ❖ iTunes tracks aren't displayed in the library.

- Activate **[Show iTunes Library]** in the **[Library + Display]** tab of the **[⚙️]** menu. If **[Show iTunes Library]** is already activated, deactivate it, then activate it again. For details about importing music files, see the Serato DJ Pro software manual.
- If you selected a crate or subcrate which doesn't contain any tracks, select another crate or subcrate which does contain tracks, or import tracks into the crate or subcrate.

- ❖ **Music files in the library can't be edited (such as changing the track name).**
  - Deactivate **[Protect Library]** in the **[Library + Display]** tab of the **[⚙️]** menu.
  
- ❖ **Serato DJ Pro virtual deck isn't displayed. (Offline player is displayed.)**
  - Connect the supplied USB cable correctly. See: Connections (page 54)
  - Update Serato DJ Pro to the latest version. See: Installing Serato DJ Pro (page 95)
  
- ❖ **BPM isn't displayed./Sync and Auto Loop don't work.**
  - Mark the **[Set Beat Grid / BPM]** check box in **[Analysis Settings]** of the offline player setting, then analyze the track. For details on how to analyze a track, see the Serato DJ Pro software manual.
  
- ❖ **BPM and beatgrid are not displayed correctly./Beatgrid is misaligned.**
  - Change the BPM analysis range and analyze the track again. If it still doesn't work, manually set the beatgrid and BPM.
  - Adjust the beatgrid. For details on how to adjust the beatgrid, see the Serato DJ Pro software manual.
  
- ❖ **Sound is interrupted while using Serato DJ Pro**
  - Change the Serato DJ Pro buffer size (latency).

- ❖ **BPM is displayed, but the beatgrid isn't displayed./Skip mode doesn't work.**
- Mark the **[Set Beat Grid / BPM]** check boxes in **[Analysis Settings]** of the offline player setting, then analyze the track. For details on how to analyze a track, see the Serato DJ Pro software manual.
- Set the beatgrid. For details on how to set the beatgrid, see the Serato DJ Pro software manual.

---

### rekordbox for iOS/Android

- ❖ **When connecting to an Android device, stereo sound doesn't output correctly, MASTER output sound is distorted, then no sound outputs from headphones.**
- If the **[Android MONO/STEREO]** switch is set to **[STEREO]**, it may not connect correctly and the stereo sound may not output normally. In this case, set **[Android MONO/STEREO]** to **[MONO]** on the rear panel.
- ❖ **When the unit and a mobile device is connected, sound doesn't output from the mobile device.**
- Sound doesn't output from the mobile device when the unit and a mobile device is connected. Connect a power speaker, power amplifier, etc. to the **[MASTER]** output terminal on the unit.
- ❖ **When connecting to an Android device, audio isn't output properly or noise occurs even if the [Android MONO/STEREO] switch is set to [MONO].**
- Depending on the Android device, the connection may not work properly. In that case, contact the support below.  
[alphatheta.com/support/](http://alphatheta.com/support/)

### ❖ rekordbox becomes unstable.

- Update rekordbox to the latest version. See: Installing rekordbox for iOS/Android (page 126)
- Quit any other applications on your mobile device. If rekordbox remains unstable, try disabling the wireless network or other wireless connections, antivirus application, low-power mode, etc. (When quitting antivirus security software, before doing so, disable the internet connection to ensure the security of your mobile device.)

### ❖ BPM and beatgrid are not displayed correctly./Beatgrid is misaligned.

- Change the BPM analysis range and analyze the track again. If it doesn't work, manually set the beatgrid and BPM.

### ❖ Fader Start doesn't work.

- Set a cue.
- To activate Fader Start, set **[Fader Start]** to on in **[Settings] > [DDJ-GRV6]** in rekordbox.

---

## Others

### ❖ The indicator flashes and the unit doesn't seem to be working properly.

- If the unit behaves unusually or doesn't turn on, disconnect the USB cables from the USB port (for power supply) and USB port (for device connection), wait a while, then turn on the unit with reconnecting the USB cables. If it still doesn't work, consult an authorized service company or your dealer.

## Specifications

### General – Main Unit

#### Rated power supply

When a USB power adapter is used .....DC 9 V, 3.0 A

When a USB bus power is used.....DC 5 V, 1.5 A

Main unit weight.....4.6 kg / 10.2 lbs.

#### Max. external dimensions (W x D x H)

..... 711.4 × 375.9 × 75.7 mm / 28.0" × 14.8" × 3.0"

Tolerable operating temperature..... +5 °C – +35 °C (+41 °F – +95 °F)

Tolerable operating humidity..... 5 % – 85 % (no condensation)

### Audio Section

Sampling rate ..... 48 kHz

A/D, D/A converters ..... 24 bit

#### Frequency characteristic

**USB, MIC** .....20 Hz – 20 kHz

#### S/N ratio (rated output, A-WEIGHTED)

**USB** ..... 104 dB

#### Total harmonic distortion (20 Hz – 20 kHz BW)

**USB** ..... 0.003 %

#### Input impedance

**MIC** .....3 kΩ

#### Output impedance

**MASTER 1** ..... 560 Ω or less

**MASTER 2** ..... 1 kΩ or less

**BOOTH**..... 1 kΩ or less

**Headphones** ..... 10 Ω or less

#### Rated output level / Load impedance

**MASTER 1** ..... 3.30 Vrms / 10 kΩ

**MASTER 2** ..... 2.10 Vrms / 10 kΩ

**BOOTH**..... 2.10 Vrms / 10 kΩ



## Input / Output terminals

### MIC input terminal

1/4" TRS jack ..... 1 set

### MASTER 1 output terminal

1/4" TRS jack ..... 1 set

### MASTER 2 output terminal

RCA pin jacks ..... 1 set

### BOOTH output terminal

RCA pin jacks ..... 1 set

### Headphones output terminals

1/4" stereo jack ..... 1 set

3.5 mm stereo mini jack ..... 1 set

### USB ports

USB Type-C ..... 2 sets

- Be sure to use the **[MASTER 1]** output terminals for a balanced output.

If these terminals are connected to an unbalanced input (such as RCA) using an TRS to RCA converter cable (or converter adapter), etc., the sound quality may be lowered or unwanted noise may occur. For connection with an unbalanced input (such as RCA), use the **[MASTER 2]** output terminals.

- The specifications and design of this product are subject to change without notice.

### **Using the unit as a controller for other DJ applications**

The unit also outputs operating data for the buttons and knobs in MIDI format. If you connect a PC/Mac with MIDI compatible DJ application installed, via the USB cable, you can control the DJ application with the unit. (You need to set MIDI details in the DJ application.)

- For details, see your DJ application's user guide.

---

### **About MIDI messages**

For details on the unit's MIDI messages, see the List of MIDI Messages.

- You can find the List of MIDI Messages on the website below.  
[alphatheta.com/support/](http://alphatheta.com/support/)

---

---

## Trademarks and registered trademarks

- rekordbox™ is a trademark or registered trademark of AlphaTheta Corporation.
- Apple, Apple Logo, Apple Music, Finder, iPad, iPadOS, iTunes, Mac, MacBook, MacBook Pro, macOS and OS X are trademarks of Apple Inc., registered in the U.S. and other countries and regions.
- App Store is a service mark of Apple Inc.
- Windows is a trademark or registered trademark of Microsoft Corporation in the U.S. and other countries.
- iOS is a trademark or registered trademark of Cisco in the U.S. and other countries and regions.
- Google Play, Google Play Logo and Android are registered trademarks of Google LLC.
- Serato DJ Lite, Serato DJ Intro, Serato DJ Pro, Serato DJ and Scratch Live are registered trademarks of Serato Limited.

Other product, technology and company names, etc. mentioned herein are trademarks or registered trademarks of their respective owners.

### About using MP3 files

This product has been licensed for nonprofit use. This product has not been licensed for commercial purposes (for profit-making use), such as broadcasting (terrestrial, satellite, cable or other types of broadcasting), streaming on the Internet, Intranet (a corporate network) or other types of networks or distributing of electronic information (online digital music distribution service). You need to acquire the corresponding licenses for such uses. For details, refer to <http://www.mp3licensing.com>.

## Software license notice

### Apache

Copyright (c) 2009-2019 ARM Limited. All rights reserved.

SPDX-License-Identifier: Apache-2.0

Licensed under the Apache License, Version 2.0 (the License); you may not use this file except in compliance with the License. You may obtain a copy of the License at

[www.apache.org/licenses/LICENSE-2.0](http://www.apache.org/licenses/LICENSE-2.0)

Unless required by applicable law or agreed to in writing, software distributed under the License is distributed on an AS IS BASIS, WITHOUT WARRANTIES OR CONDITIONS OF ANY KIND, either express or implied.

See the License for the specific language governing permissions and limitations under the License.

### BSD

The BSD-3-Clause License

Copyright (c) 2015, Freescale Semiconductor, Inc.

Copyright 2016-2020 NXP

All rights reserved.

Redistribution and use in source and binary forms, with or without modification, are permitted provided that the following conditions are met:

1. Redistributions of source code must retain the above copyright notice, this list of conditions and the following disclaimer.

## Additional information

2. Redistributions in binary form must reproduce the above copyright notice, this list of conditions and the following disclaimer in the documentation and/or other materials provided with the distribution.
3. Neither the name of the copyright holder nor the names of its contributors may be used to endorse or promote products derived from this software without specific prior written permission.

THIS SOFTWARE IS PROVIDED BY THE COPYRIGHT HOLDERS AND CONTRIBUTORS "AS IS" AND ANY EXPRESS OR IMPLIED WARRANTIES, INCLUDING, BUT NOT LIMITED TO, THE IMPLIED WARRANTIES OF MERCHANTABILITY AND FITNESS FOR A PARTICULAR PURPOSE ARE DISCLAIMED. IN NO EVENT SHALL THE COPYRIGHT HOLDER OR CONTRIBUTORS BE LIABLE FOR ANY DIRECT, INDIRECT, INCIDENTAL, SPECIAL, EXEMPLARY, OR CONSEQUENTIAL DAMAGES (INCLUDING, BUT NOT LIMITED TO, PROCUREMENT OF SUBSTITUTE GOODS OR SERVICES; LOSS OF USE, DATA, OR PROFITS; OR BUSINESS INTERRUPTION) HOWEVER CAUSED AND ON ANY THEORY OF LIABILITY, WHETHER IN CONTRACT, STRICT LIABILITY, OR TORT (INCLUDING NEGLIGENCE OR OTHERWISE) ARISING IN ANY WAY OUT OF THE USE OF THIS SOFTWARE, EVEN IF ADVISED OF THE POSSIBILITY OF SUCH DAMAGE.

## Cautions on copyrights

rekordbox restricts playback and duplication of copyright-protected music contents.

- When coded data, etc., for protecting the copyright is embedded in the music contents, it may not be possible to operate the program normally.
- When rekordbox detects that coded data, etc., for protecting the copyright is embedded in the music contents, processing (playback, reading, etc.) may stop.

Recordings you have made are for your personal enjoyment and according to copyright laws may not be used without the consent of the copyright holder.

- Music recorded from CDs, etc., is protected by the copyright laws of individual countries and by international treaties. It is the full responsibility of the person who has recorded the music to ensure that it is used legally.
- When handling music downloaded from the Internet, etc., it is the full responsibility of the person who has downloaded the music to ensure that it is used in accordance with the contract concluded with the download site.

The specifications and design of this product are subject to change without notice.

© 2024 AlphaTheta Corporation

All rights reserved.

<DRI1927-A>