

NEO i Series (Passive)

NEO i Series (Active)



User Manual

NEO 40 i

WORKiCa PRO®

A NEO 40i carton contains two loudspeakers (black or white) and two PB-5 wall-mount brackets.

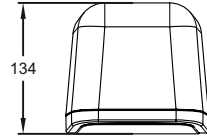
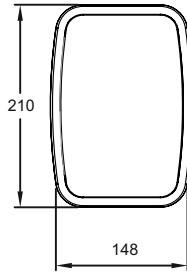
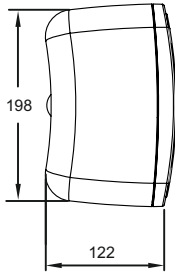

ⓘ The power tap is selected by rotating the slot of the 5 position rotary switch to the desired tap.



Make sure to select the correct power tap position before connecting the loudspeaker to a 70/100V line amplifier. If the low impedance position (8Ω) is selected, the loudspeaker could be damaged!

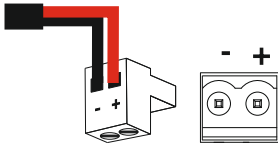

The connection is made through Euroblock terminals. Ensure the correct polarity is observed.

(*) Power Taps (70V)	1W(4k9Ω)/2W(2k45Ω)/4W(1k22Ω)/8W(612Ω)
Power Taps (100V)	2W(5kΩ)/4W(2k5Ω)/8W(1k2Ω)/16W(625Ω)
Low Impedance position	8Ω (30W)
Sensitivity (1W/1m)	87 dB
Max. SPL	99 dB
Frequency Response	70Hz - 20kHz
Elements	4" Woofer + 0,5" Tweeter
Dimensions	148 x 210 x 134 mm
Material (enclosure)	ABS plastic
IP rating	IP 54
RAL colour code	RAL 9003 (W) / RAL 9004 (B)
Material (grille)	Aluminium
Weight	1,95 Kg

(*) The power taps indicated on the selector switch are calculated for 100V line. In the case of 70V line installation, each power tap will correspond to half the value.

Specifications are subject to change without notice

NEO 50 i

WORKiCa PRO®

A NEO 50i carton contains two loudspeakers (black or white) and two PB-5 wall-mount brackets.

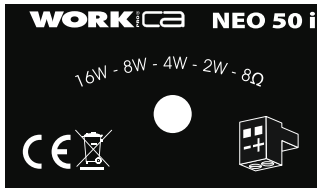
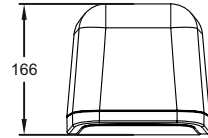
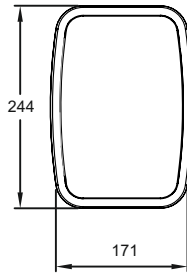
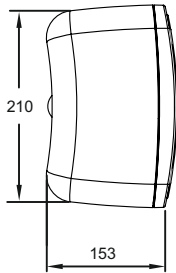

 The power tap is selected by rotating the slot of the 5 position rotary switch to the desired tap.



Make sure to select the correct power tap position before connecting the loudspeaker to a 70/100V line amplifier. If the low impedance position (8Ω) is selected, the loudspeaker could be damaged!

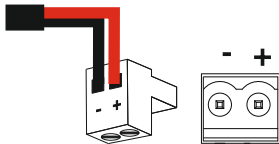

The connection is made through Euroblock terminals. Ensure the correct polarity is observed.

(*) Power Taps (70V)	1W(4k9Ω)/2W(2k45Ω)/4W(1k22Ω)/8W(612Ω)
Power Taps (100V).....	2W(5kΩ)/4W(2k5Ω)/8W(1k2Ω)/16W(625Ω)
Low Impedance position.....	8Ω (40W)
Sensitivity (1W/1m)	88 dB
Max. SPL	100 dB
Frequency Response	60Hz - 20kHz
Elements.....	5" Woofer + 0,5" Tweeter
Dimensions	171 x 244 x 166 mm
Material (enclosure)	ABS plastic
IP rating	IP 54
RAL colour code	RAL 9003 (W) / RAL 9004 (B)
Material (grille)	Aluminium
Weight	2,3 Kg

(*) The power taps indicated on the selector switch are calculated for 100V line. In the case of 70V line installation, each power tap will correspond to half the value.

Specifications are subject to change without notice

NEO 60 i

WORKiCa PRO®

A NEO 60i carton contains two loudspeakers (black or white) and two PB-5 wall-mount brackets.

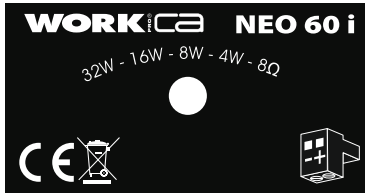
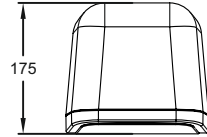
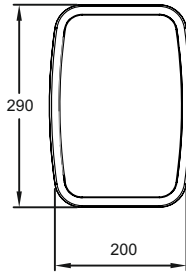
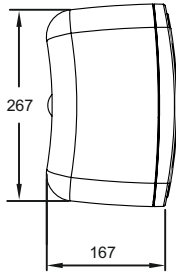

 The power tap is selected by rotating the slot of the 5 position rotary switch to the desired tap.



Make sure to select the correct power tap position before connecting the loudspeaker to a 70/100V line amplifier. If the low impedance position (8Ω) is selected, the loudspeaker could be damaged!

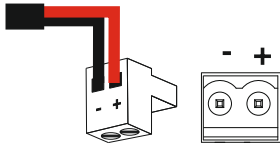

The connection is made through Euroblock terminals. Ensure the correct polarity is observed.

(*) Power Taps (70V)	2W(2k45Ω)/4W(1k22Ω)/8W(612Ω)16W(306Ω)
Power Taps (100V)	4W(2k5Ω)/8W(1k2Ω)/16W(625Ω)/32W(312Ω)
Low Impedance position.....	8Ω (60W)
Sensitivity (1W/1m)	89 dB
Max. SPL	101 dB
Frequency Response	70Hz - 20kHz
Elements.....	6.5" Woofer + 1" Tweeter
Dimensions	200 x 290 x 175 mm
Material (enclosure)	ABS plastic
IP rating	IP 54
RAL colour code	RAL 9003 (W) / RAL 9004 (B)
Material (grille)	Aluminium
Weight	3,1 Kg

(*) The power taps indicated on the selector switch are calculated for 100V line. In the case of 70V line installation, each power tap will correspond to half the value

Specifications are subject to change without notice

NEO 80 i

WORKiCa PRO®

A NEO 80i carton contains two loudspeakers (black or white) and two PB-5 wall-mount brackets.

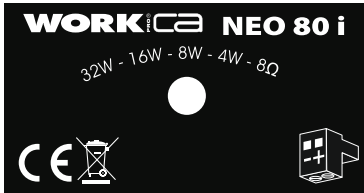
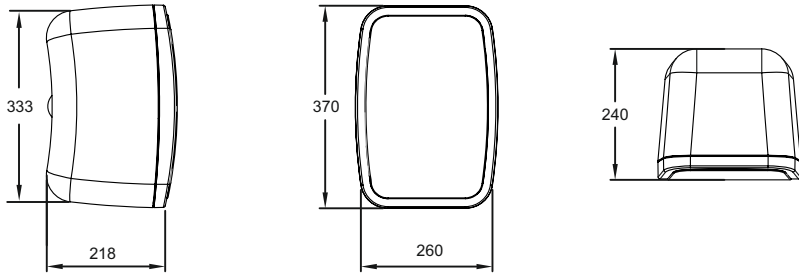

 The power tap is selected by rotating the slot of the 5 position rotary switch to the desired tap.

 Make sure to select the correct power tap position before connecting the loudspeaker to a 70/100V line amplifier. If the low impedance position (8Ω) is selected, the loudspeaker could be damaged!

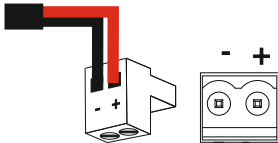

The connection is made through Euroblock terminals. Ensure the correct polarity is observed.

(*) Power Taps (70V)	2W(2k45Ω)/4W(1k22Ω)/8W(612Ω)/16W(306Ω)
Power Taps (100V)	4W(2k5Ω)/8W(1k2Ω)/16W(625Ω)/32W(312Ω)
Low Impedance position	8Ω (70W)
Sensitivity (1W/1m)	87 dB
Max. SPL	101 dB
Frequency Response	52Hz - 20kHz
Elements	8" Woofer + 1" Tweeter
Dimensions	260 x 370 x 240 mm
Material (enclosure)	ABS plastic
IP rating	IP 54
RAL colour code	RAL 9003 (W) / RAL 9004 (B)
Material (grille)	Aluminium
Weight	4,95 Kg

(*) The power taps indicated on the selector switch are calculated for 100V line. In the case of 70V line installation, each power tap will correspond to half the value.

Specifications are subject to change without notice

NEO 50 Ai

WORKca PRO®

A NEO 50Ai carton contains an active loudspeaker and a passive one (black or white), two PB-5 wall-mount brackets, and a 3m link cable.

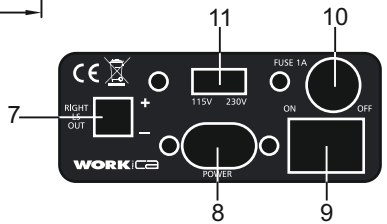
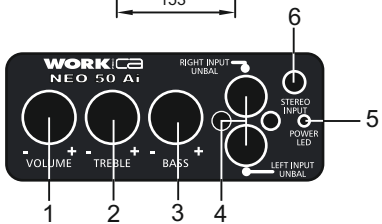
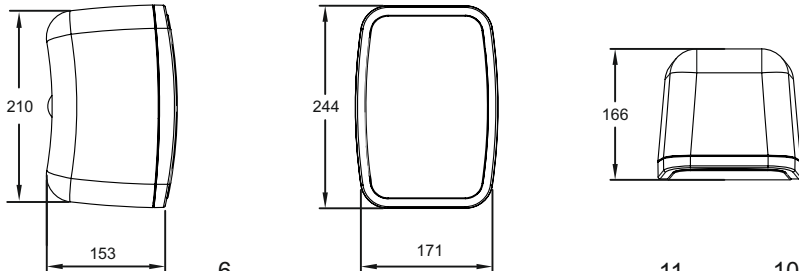

1	Volume Control
2	Treble Control
3	Bass Control
4	L/R Unbalanced Input (RCA connectors)
5	LED power
6	Stereo input (Mini-jack 3.5 mm) (*)

7	Link connection 2-pin euroblock (Passive unit)
8	Mains supply input (Use the included cable)
9	Power Switch ON/OFF
10	Fuse Holder
11	AC 115V/230V main power selector

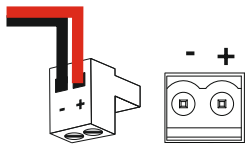

(*) **This connector overrides RCA input**

The connection is made through euroblock terminals. Take it into account the correct polarity. Use the included twin conductors cable (Red/Black) 3m long to connect both loudspeakers.

Elements.....	5" Woofer + 0,5" Tweeter
Power Output	2 x 25 W RMS
Input Sensitivity	0.7 V/ -0.87 dBu
Headroom	14 dB
Max. SPL	99 dB
Frequency Response	60Hz - 20kHz
Dimensions	171 x 244 x 166 mm
Material (enclosure)	ABS plastic
IP rating	IP 54
RAL colour code	RAL 9003 (W) / RAL 9004 (B)
Material (grille)	Aluminium
Weight	2,7 Kg

NEO 60 Ai

WORKi PRO® **ca**

A NEO 60Ai carton contains an active loudspeaker and a passive one (black or white), two PB-5 wall-mount brackets, and a 3m link cable.

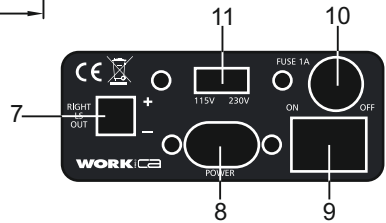
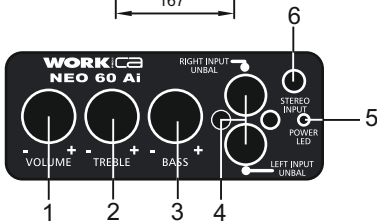
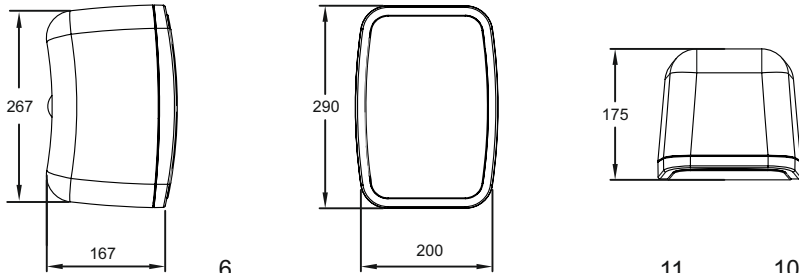

1	Volume Control
2	Treble Control
3	Bass Control
4	L/R Unbalanced Input (RCA connectors)
5	LED power
6	Stereo input (Mini-jack 3.5 mm) (*)

7	Link connection 2-pin euroblock (Passive unit)
8	Mains supply input (Use the included cable)
9	Power Switch ON/OFF
10	Fuse Holder
11	AC 115V/230V main power selector

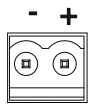

(*) **This connector overrides RCA input**

The connection is made through euroblock terminals. Take it into account the correct polarity.

Use the included twin conductors cable (Red/Black) 3m long to connect both loudspeakers.

Elements.....	6.5" Woofer + 1" Tweeter
Power Output	2 x 30 W RMS
Input Sensitivity	0.7 V /-0.87 dBu
Headroom	14 dB
Max. SPL	100 dB
Frequency Response	55Hz - 20kHz
Dimensions	200 x 290 x 175 mm
Material (enclosure)	ABS plastic
IP rating	IP 54
RAL colour code	RAL 9003 (W) / RAL 9004 (B)
Material (grille)	Aluminium
Weight	3,3 Kg

Specifications are subject to change without notice

NEOi A Series, Anti-clip system (Explanation)

The NEOi A series features an anti-clip system. If the 1V nominal input level is exceeded, the anti-clip circuit will operate, attenuating the signal to prevent a clipped signal which could cause the amplifier to distort. Low distortion electronic circuitry is used to maintain the clarity of the input signal.

There are no user controls for the anti-clip circuit. If the level cannot be heard to increase when the input level is increased, then the anti-clip circuit is operating, and the input level or the VOLUME control should be decreased. Note that protection is not provided for excessively high input levels (above 4V).

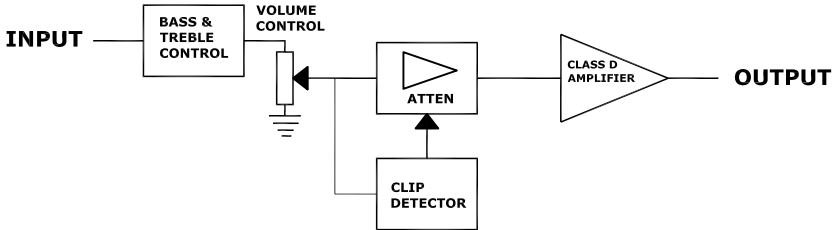

IP54 weather proof rating

The NEOi series is rated to IP54 which means there is limited dust and water ingress protection.

The NEOi series is designed for both indoor and outdoor operation where it is protected from direct exposure to water (e.g. under a canopy). The use of protection from water and humidity for the connection terminals is highly recommended (e.g. sealant/mastic).

PB-5 Wall-mount bracket (included)

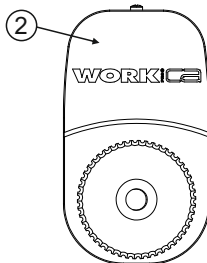
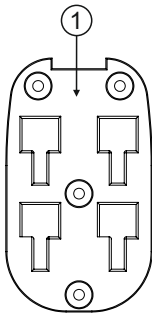

1	Rear wall mounting part
2	Front threaded part with studded socket
3	Rotary knurled ring
4	Threaded Ball
5	M8 nut
6	Rear threaded insert (mounted to loudspeaker)
7	Screw eyelet for safety cable (*)
8	Self-tapping screw

(*) Safety cable not included

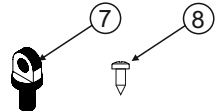
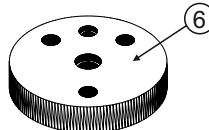
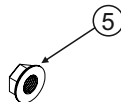
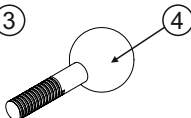
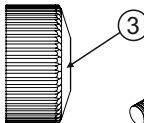

Mounting Process

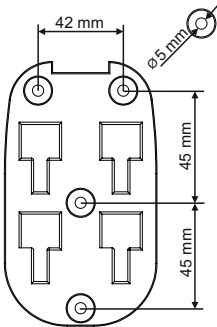

figure 1

Use the wall mounting part (1) to mark the fixing points on the wall. Take into account the dimensions between holes and the diameters marked in figure 1.

Drill wall and insert wall fixings. Screw wall mounting part to wall. Ensure that suitable screws and wall fixings are used. If in any doubt contact a suitably qualified expert.

Mount (3), (4) & (5) as shown in figure 2. Screw the threaded ball (4) into the threaded insert on the rear of the loudspeaker (6) (loudspeaker not shown below). Tighten M8 nut (5) against the loudspeaker with a spanner. The assembly will now be as shown in figure 3.

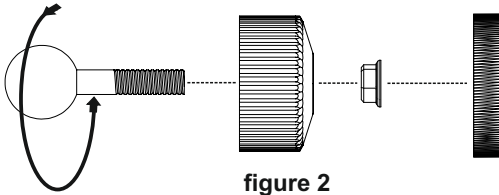

figure 2

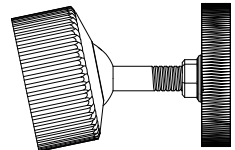

figure 3

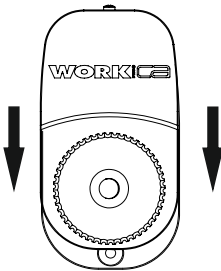
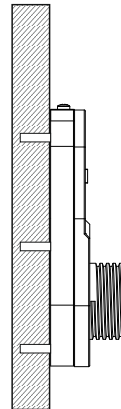
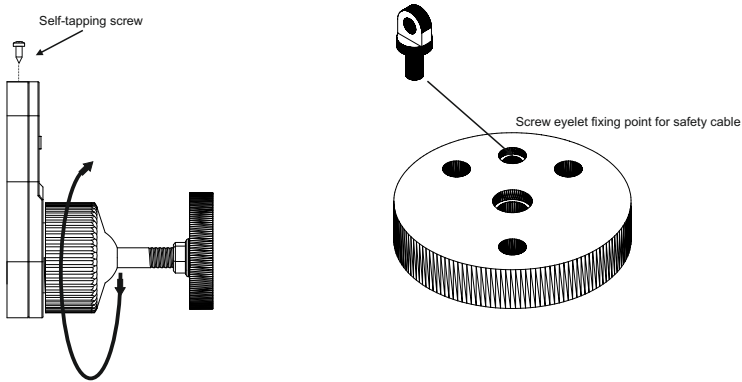

figure 4

Slide the hooks of the front threaded part (2) down in to the slots of the wall mount part (1). (figure 4)



Screw on the rotary knurled ring (3) several turns (do not tighten completely).
 Now adjust the loudspeaker to the desired position.
 Hold the speaker in position and tighten the knurled ring (3) completely.
 Use the self tapping screw (7) provided in order to lock parts (1) & (2) together.



WARNING: The maximum loading of PB 5 bracket (8 kg), must never be exceeded.
 No other items must be suspended or attached to the bracket or speaker enclosure.



MB-5 Wall-mount bracket (optional)

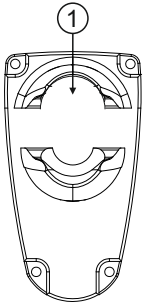

1	Rear wall mounting part
2	Allen Screw 45 mm x M5
3	M5 screw
4	Threaded Ball
5	M8 nut
6	Rear threaded insert (mounted to loudspeaker)
7	Screw eyelet for safety cable (*)

(*) Safety cable not included

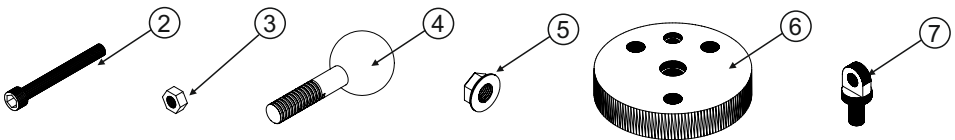

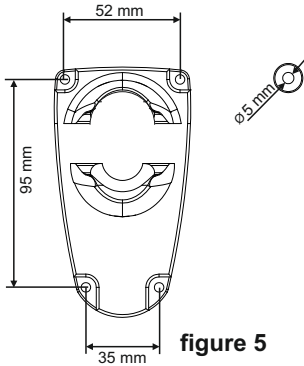
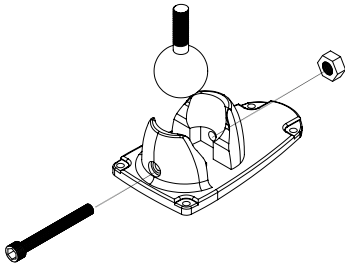

figure 5

Use the wall mounting part (1) to mark the fixing points on the wall. Take into account the dimensions between holes and the diameters marked in figure 1. Drill wall and insert wall fixings. Screw wall mounting part to wall. Ensure that suitable screws and wall fixings are used. If in any doubt contact a suitably qualified expert.



Unscrew the M5 Allen screw (2) to release the threaded ball (4).

Mount (4) & (5) as shown in figure 6. Screw the threaded ball (4) into the threaded insert on the rear of the loudspeaker (6) (loudspeaker not shown below). Tighten M8 nut (5) against the loudspeaker with a spanner. The assembly will now be as shown in figure 7.

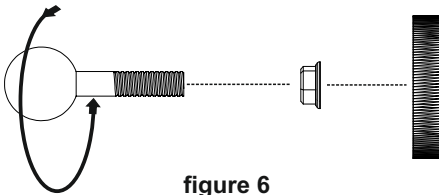

figure 6

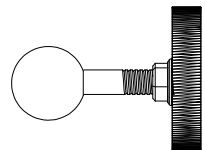
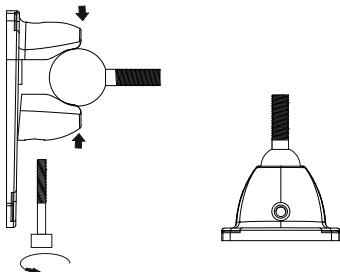

figure 7



Insert the complete assembly into the wall mounting part, screw the Allen screw (2) several turns (do not tighten completely). Now adjust the loudspeaker to the desired position. Hold the speaker in position and tighten the screw completely.

WARNING: The maximum loading of MB 5 bracket (10 kg), must never be exceeded. No other items must be suspended or attached to the bracket or speaker enclosure.





Important Warranty Information

WORK pro CA products are exclusively distributed in Europe by

Yamaha Music Europe GmbH.
Siemensstrasse 22-34
D-25462 Rellingen, b. Hamburg, Germany

- EN For information regarding the warranty and for user manuals in other languages please go to:**
- FR Les manuels d'utilisation en français ainsi que les informations concernant la garantie son accessible à l'adresse suivante:**
- DE Die deutschen Bedienungsanleitungen und Informationen zu der Gewährleistung finden sie auf der Website:**
- ES Para la información relativa a las condiciones de garantía y los manuales de usuario en español, por favor acceda a la página web:**
- IT Per le informazioni riguardanti la garanzia e per i Manuali d'Uso nelle altre lingue si prega di visitare il sito:**

<http://www.workproca.com>



This symbol on the product or on its packaging indicates that this product shall not be treated as household waste. Instead it shall be handed over to the applicable collection point for the recycling of electrical and electronic equipment. By ensuring this product is disposed of correctly, you will help prevent potential negative consequences for the environment and human health, which could otherwise be caused by inappropriate waste handling of this product. The recycling of materials will help to conserve natural resources. For more detailed information about recycling of this product, please contact your local city office, your household waste disposal service or the shop where you purchased the product.

Manufactured by **EQUIPSON, S.A.**