

# Privia

# PX-560M

EN/ES

English

Español

## USER'S GUIDE

## GUÍA DEL USUARIO

Please keep all information for future reference.  
Guarde toda información para tener como referencia futura.

### **Safety Precautions**

Before trying to use the Digital Piano, be sure to read the separate "Safety Precautions".

### **Precauciones de seguridad**

Antes de intentar usar el piano digital, asegúrese de leer las "Precauciones de seguridad" separadas.

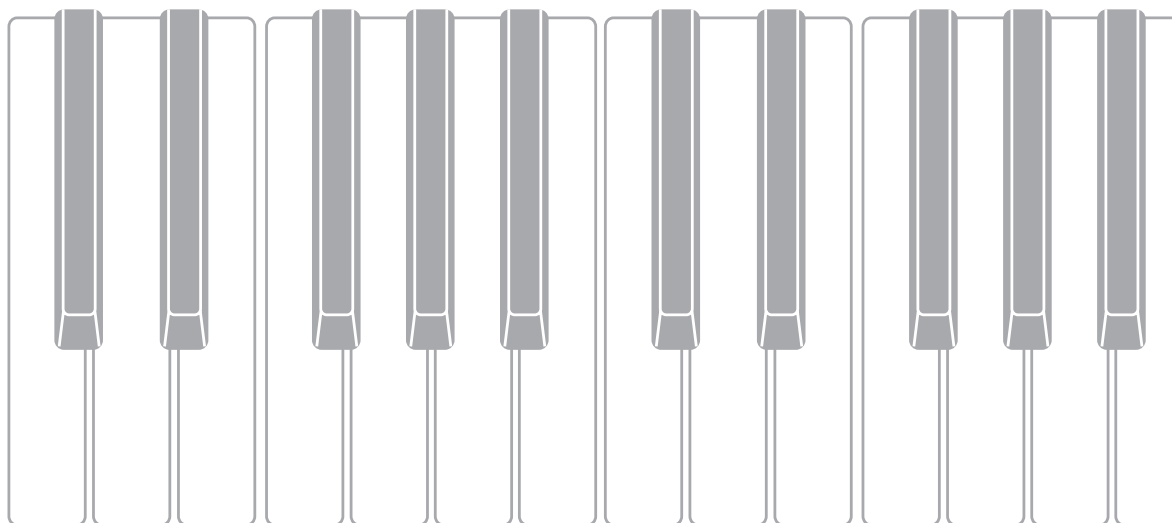

## IMPORTANT SAFETY INSTRUCTIONS

1. Read these instructions.
2. Keep these instructions.
3. Heed all warnings.
4. Follow all instructions.
5. Do not use this apparatus near water.
6. Clean only with dry cloth.
7. Do not block any ventilation openings. Install in accordance with the manufacturer's instructions.
8. Do not install near any heat sources such as radiators, heat registers, stoves, or other apparatus (including amplifiers) that produce heat.
9. Do not defeat the safety purpose of the polarized or grounding-type plug. A polarized plug has two blades with one wider than the other. A grounding type plug has two blades and a third grounding prong. The wide blade or the third prong are provided for your safety. If the provided plug does not fit into your outlet, consult an electrician for replacement of the obsolete outlet.
10. Protect the power cord from being walked on or pinched particularly at plugs, convenience receptacles, and the point where they exit from the apparatus.
11. Only use attachments/accessories specified by the manufacturer.
12. Use only with the cart, stand, tripod, bracket, or table specified by the manufacturer, or sold with the apparatus. When a cart is used, use caution when moving the cart/apparatus combination to avoid injury from tip-over.
13. Unplug this apparatus during lightning storms or when unused for long periods of time.
14. Refer all servicing to qualified service personnel. Servicing is required when the apparatus has been damaged in any way, such as power-supply cord or plug is damaged, liquid has been spilled or objects have fallen into the apparatus, the apparatus has been exposed to rain or moisture, does not operate normally, or has been dropped.



The apparatus shall not be exposed to dripping or splashing and that no objects filled with liquids, such as vases, shall be placed on the apparatus.

The  (POWER) indicator being unlit does not mean the apparatus is completely disconnected from the MAINS. When you need to have the apparatus completely disconnected from the MAINS, you must unplug the power cord. For that purpose, locate the apparatus in a way that secures easy access to the power cord.

## Declaration of Conformity

Model Number: PX-560M  
Trade Name: CASIO COMPUTER CO., LTD.  
Responsible party: CASIO AMERICA, INC.  
Address: 570 MT. PLEASANT AVENUE, DOVER, NEW JERSEY 07801  
Telephone number: 973-361-5400

This device complies with Part 15 of the FCC Rules, Operation is subject to the following two conditions:

(1) This device may not cause harmful interference, and (2) this device must accept any interference received, including interference that may cause undesired operation.

## NOTICE

This equipment has been tested and found to comply with the limits for a Class B digital device, pursuant to Part 15 of the FCC Rules. These limits are designed to provide reasonable protection against harmful interference in a residential installation. This equipment generates, uses and can radiate radio frequency energy and, if not installed and used in accordance with the instructions, may cause harmful interference to radio communications. However, there is no guarantee that interference will not occur in a particular installation. If this equipment does cause harmful interference to radio or television reception, which can be determined by turning the equipment off and on, the user is encouraged to try to correct the interference by one or more of the following measures:

- Reorient or relocate the receiving antenna.
- Increase the separation between the equipment and receiver.
- Connect the equipment into an outlet on a circuit different from that to which the receiver is connected.
- Consult the dealer or an experienced radio/TV technician for help.

## FCC CAUTION

Changes or modifications not expressly approved by the party responsible for compliance could void the user's authority to operate the equipment.

## Important!

Please note the following important information before using this product.

- Before using the AD-A12150LW Adaptor to power the product, be sure to check the AC Adaptor for any damage first. Carefully check the power cord for breakage, cuts, exposed wire and other serious damage. Never let children use an AC adaptor that is seriously damaged.
- The product is not intended for children under 3 years.
- Use only the CASIO AD-A12150LW adaptor.
- The AC adaptor is not a toy.
- Be sure to disconnect the AC adaptor before cleaning the product.

Declaration of Conformity According to EU Directive

 Manufacturer:  
CASIO COMPUTER CO., LTD.  
6-2, Hon-machi 1-chome, Shibuya-ku, Tokyo 151-8543, Japan  
Responsible within the European Union:  
Casio Europe GmbH  
Casio-Platz 1, 22848 Norderstedt, Germany  
www.casio-europe.com

# Contents

## **General Guide** **EN-4**

- Installing the Music Stand . . . . . EN-5
- Saving Settings and Using Panel Lock . . . . . EN-6
- Returning the Digital Piano to Its Factory Default Settings . . . . . EN-6

## **Power Outlet** **EN-7**

- Using an AC Adaptor . . . . . EN-7
- Turning Power On or Off . . . . . EN-7

## **Connections** **EN-9**

- Connecting Headphones . . . . . EN-9
- Connecting a Pedal . . . . . EN-9
- Connecting Audio Equipment or an Amplifier . . . . . EN-10
- Bundled and Optional Accessories . . . . . EN-11

## **Operations Common to All Modes** **EN-12**

- Using the Display Screen . . . . . EN-12
- Performing Operations . . . . . EN-13

## **Playing with Different Tones** **EN-15**

- Selecting and Playing a Tone . . . . . EN-15
- Splitting the Keyboard between Two Tones . . EN-16
- Layering Two Tones . . . . . EN-17
- Splitting the Keyboard for Duet Play . . . . . EN-17
- Adjusting the Keyboard Volume Balance . . . EN-19
- Using the Metronome . . . . . EN-19
- Changing the Tempo Setting . . . . . EN-20
- Using the Pitch Bend Wheel . . . . . EN-20
- Modifying Notes with the Modulation Wheel and Knobs . . . . . EN-20
- Shifting the Pitch of the Digital Piano in Semitone Units (Transpose) . . . . . EN-21
- Sounding Arpeggio Phrases Automatically (Arpeggiator) . . . . . EN-22

## **Editing a Tone** **EN-23**

- Editing a Tone . . . . . EN-23
- Changing the Name of a Tone . . . . . EN-24
- Deleting a Tone . . . . . EN-24

## **Using Auto Accompaniment** **EN-38**

- Playing an Auto Accompaniment . . . . . EN-38
- Using Recommended Tones and Tempos (One-Touch Presets) . . . . . EN-41
- Adding Harmony to Melody Notes (Auto Harmonize) . . . . . EN-42
- Creating Your Own Original Rhythm by Editing a Built-in Auto Accompaniment (Rhythm Edit) . . . . . EN-42
- Deleting a User Rhythm . . . . . EN-44

## **Demo Song** **EN-45**

- Playing the Demo Tunes . . . . . EN-45

## **Music Presets** **EN-46**

- Recalling Preset Data . . . . . EN-46
- Creating an Original User Preset (User Presets) . . . . . EN-47
- Deleting a User Preset . . . . . EN-51

## **Registering Tone and Rhythm Setups** **EN-52**

## **Recording and Playback** **EN-54**

- Recording to Digital Piano Memory (MIDI Recorder) . . . . . EN-56
- Recording to a USB Flash Drive (Audio Recorder) . . . . . EN-65

## **Configuring Digital Piano Settings** **EN-68**

- Configuring Digital Piano Settings . . . . . EN-68

## **USB Flash Drive** **EN-82**

- Connecting a USB Flash Drive to and Detaching It from the Digital Piano . . . . . EN-83
- Formatting a USB Flash Drive . . . . . EN-84
- Saving Standard Song Data to a USB Flash Drive . . . . . EN-84
- Saving Digital Piano Data to a USB Flash Drive . . . . . EN-84
- Loading Data from a USB Flash Drive to Digital Piano Memory . . . . . EN-85
- Deleting Data from a USB Flash Drive . . . . . EN-85

## **Connecting to a Computer** **EN-86**

- Minimum Computer System Requirements . . EN-86
- Using MIDI . . . . . EN-87

## **Reference** **EN-88**

- Error Messages . . . . . EN-88
- Troubleshooting . . . . . EN-89
- Product Specifications . . . . . EN-91
- Operating Precautions . . . . . EN-93

**Information****A-1**

Fingering Guide.....	A-1
Chord Example List.....	A-3
Part and MIDI Channel Assignments and Diagram.....	A-5
Block Diagram.....	A-6

**MIDI Implementation Chart**

Company and product names used in this manual may be registered trademarks of others.

# General Guide

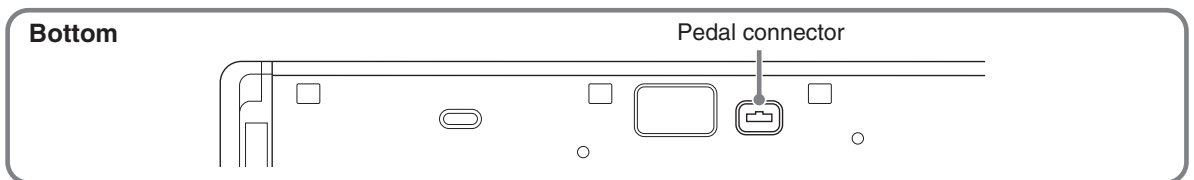
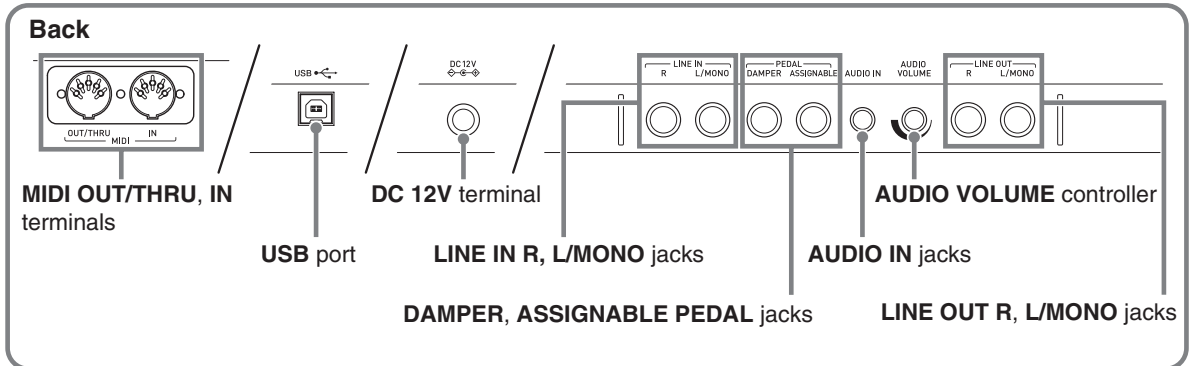
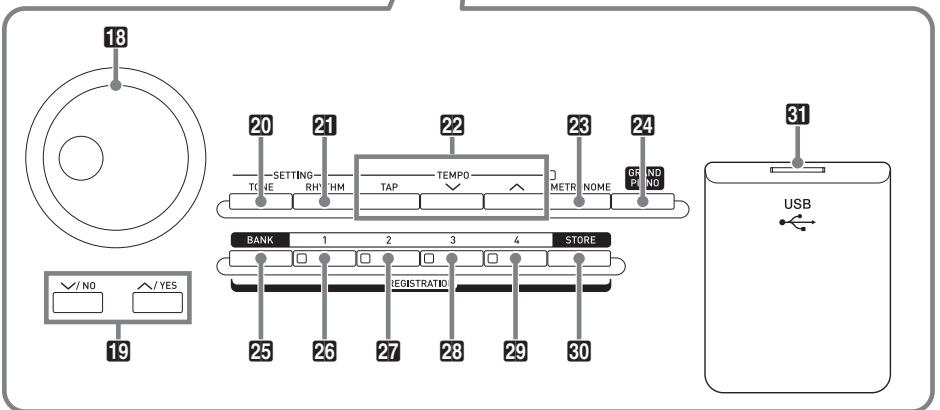
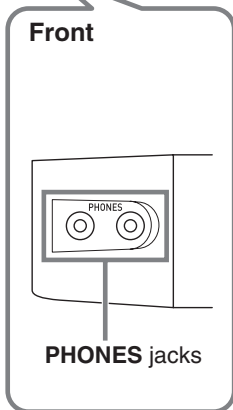
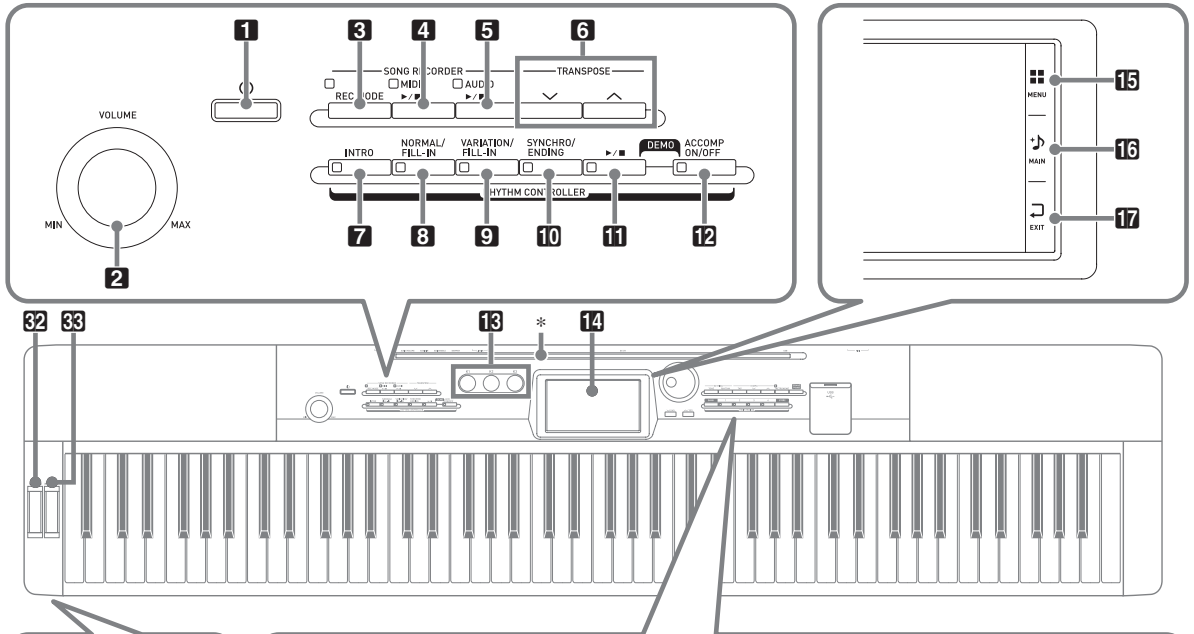

- This manual uses the numbers and names below to refer to buttons and controllers.

- |                                   |                                 |
|-----------------------------------|---------------------------------|
| <b>1</b> ⏻ (Power) button         | <b>18</b> Dial                  |
| <b>2</b> VOLUME controller        | <b>19</b> ∨/NO, ∧/YES buttons   |
| <b>3</b> REC MODE button          | <b>20</b> TONE button           |
| <b>4</b> MIDI ▶/■ button          | <b>21</b> RHYTHM button         |
| <b>5</b> AUDIO ▶/■ button         | <b>22</b> TEMPO buttons         |
| <b>6</b> TRANSPOSE ∨, ∧ buttons   | <b>23</b> METRONOME button      |
| <b>7</b> INTRO button             | <b>24</b> GRAND PIANO button    |
| <b>8</b> NORMAL/FILL-IN button    | <b>25</b> BANK button           |
| <b>9</b> VARIATION/FILL-IN button | <b>26</b> REGISTRATION 1 button |
| <b>10</b> SYNCHRO/ENDING button   | <b>27</b> REGISTRATION 2 button |
| <b>11</b> ▶/■ button              | <b>28</b> REGISTRATION 3 button |
| <b>12</b> ACCOMP ON/OFF button    | <b>29</b> REGISTRATION 4 button |
| <b>13</b> K1 through K3 knobs     | <b>30</b> STORE button          |
| <b>14</b> Display                 | <b>31</b> USB flash drive port  |
| <b>15</b> MENU                    | <b>32</b> PITCH BEND wheel      |
| <b>16</b> MAIN                    | <b>33</b> MODULATION wheel      |
| <b>17</b> EXIT                    |                                 |

## \* Installing the Music Stand

Insert the bottom of the music stand into the groove on the top of the Digital Piano's console.

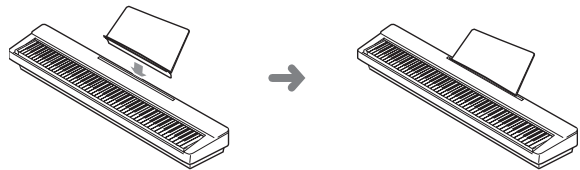

## LCD Panel

The liquid crystal panel of the monitor screen uses high-precision technology that provides a pixel yield in excess of 99.99%. This means that some very small number of pixels may not light or may remain lit at all times. This is due to the characteristics of the liquid crystal panel, and does not indicate malfunction.

## Saving Settings and Using Panel Lock

Your Digital Piano lets you save its current settings, and lock its buttons to protect against operation errors. For details, see “Auto Resume” (page EN-75) and “Operation Lock” (page EN-74).

## Returning the Digital Piano to Its Factory Default Settings

Perform the following procedure when you want to return the Digital Piano’s stored data and settings to their initial factory defaults.

1. Turn off the Digital Piano.
2. While holding down the **TEMPO**  $\vee$ ,  $\wedge$  buttons, press the **1**  $\text{U}$  button.
  - The Digital Piano will turn on and initialize its internal system. You will be able to use the Digital Piano in a short while.

### **NOTE**

- See “Turning Power On or Off” (page EN-7) for information about turning power on and off.

# Power Outlet

Your Digital Piano runs on standard household power. Be sure to turn off power whenever you are not using the Digital Piano.

## Using an AC Adaptor

Use only the AC adaptor (JEITA Standard, with unified polarity plug) that comes with this Digital Piano. Use of a different type of AC adaptor can cause malfunction of the Digital Piano.

**Specified AC Adaptor: AD-A12150LW**

- Use the supplied power cord to connect the AC adaptor as shown in the illustration below.

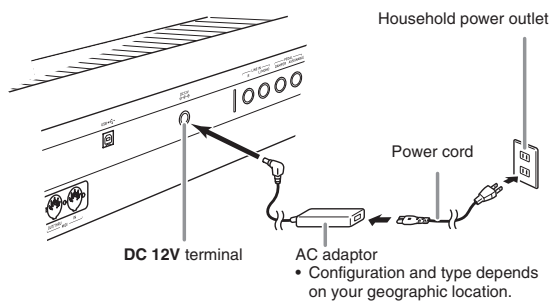

**Note the following important precautions to avoid damage to the power cord.**

### During Use

- Never pull on the cord with excessive force.
- Never repeatedly pull on the cord.
- Never twist the cord at the base of the plug or connector.

### During Movement

- Before moving the Digital Piano, be sure to unplug the AC adaptor from the power outlet.

### During Storage

- Loop and bundle the power cord, but never wind it around the AC adaptor.

## IMPORTANT!

- Never connect the AC adaptor (JEITA Standard, with unified polarity plug) that comes with this Digital Piano to any other device besides this Digital Piano. Doing so creates the risk of malfunction.
- Make sure the Digital Piano is turned off before plugging in or unplugging the AC adaptor.
- The AC adaptor will become warm to the touch after very long use. This is normal and does not indicate malfunction.
- Use the AC adaptor so its label surface is pointed downwards. The AC adaptor becomes prone to emitting electromagnetic waves when the label surface is facing upwards.

## Turning Power On or Off

### 1. Press the **1** button to turn on power.

- Do not touch the keyboard, pedals, or buttons while the startup screen is on the display. Doing so will cause malfunction.



- Use the Digital Piano's **VOLUME** controller (**2**) to adjust the volume.

### 2. To turn off the Digital Piano, hold down the **1** button until the Digital Piano's display goes blank.

## IMPORTANT!

- The message shown below may appear while data is being saved to Digital Piano memory or immediately after you turn on the Digital Piano.

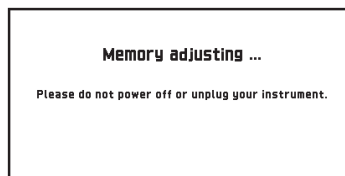

Never turn off Digital Piano power while this message is displayed.

## NOTE

- Pressing the **1**  button to turn off power actually puts the Digital Piano into a standby state. Minute amounts of current continue to flow within the Digital Piano in the standby state. If you do not plan to use the Digital Piano for a long time or if there is a lightning storm in your area, be sure to unplug the AC adaptor from the power outlet.



## Auto Power Off

This Digital Piano is designed to turn off automatically to avoid wasting power after no operation is performed for a preset amount of time. The Auto Power Off trigger time is about four hours.

### NOTE

- You can disable Auto Power Off, if you want. For details, see “Auto Power Off” under “SYSTEM SETTING Screen” (page EN-74).

# Connections

## Connecting Headphones

### IMPORTANT!

- Before connecting headphones, be sure to use the Digital Piano's **2 VOLUME** controller to turn the volume down to a low level. After connecting, you can adjust the volume to the level you want.
- While sound output from the speakers is disabled,\* the Digital Piano automatically optimizes sound for headphones and **LINE OUT** listening. During speaker output, it automatically switches to optimization for listening with speakers.

\* Plug inserted into the **PHONES** jack or "Speaker" SYSTEM SETTING Screen (page EN-74) turned off.

### Front

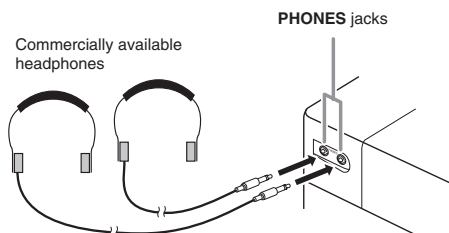

Connect commercially available headphones to the **PHONES** jacks. Connecting headphones to either of the **PHONES** jacks cuts off output to the speakers, which means you can practice even late at night without bothering others. To protect your hearing, make sure that you do not set the volume level too high when using headphones.

### NOTE

- Be sure to push the headphones plug into the **PHONES** jacks as far as it will go. If you don't, you may hear sound from only one side of the headphones.
- If the plug of the headphones you are using does not match the **PHONES** jacks, use the applicable commercially available adaptor plug.
- If you are using headphones that require an adaptor plug, make sure you do not leave the adaptor plugged in when you unplug the headphones. If you do, nothing will sound from the speakers when you play.

## Connecting a Pedal

The back of the Digital Piano has two pedal jacks, one for a damper pedal and one for a soft/sostenuto pedal.

### To connect to the pedal jack

Depending on the type of operation you want the pedal to perform, connect the pedal's cable either to the Digital Piano's **DAMPER PEDAL** jack or **ASSIGNABLE PEDAL** jack.

### Back

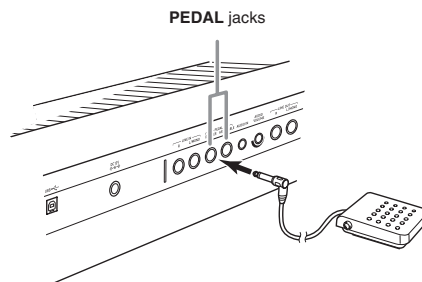

### Pedal Functions

#### ● Damper Pedal

Pressing the damper pedal while playing will cause the notes you play to reverberate.

- Whenever a piano tone is selected, pressing this pedal will activate the Digital Piano's Damper Resonance effect, which causes notes to resonate in the same way they do when the damper pedal on an acoustic piano is pressed.

#### ● Soft Pedal

Pressing this pedal suppresses notes played on the keyboard after the pedal was pressed, and makes them sound softer.

#### ● Sostenuto Pedal

Only the notes of the keys that are depressed when this pedal is pressed are sustained, even if the keyboard keys are released, until the pedal is released.

● **Expression Pedal**

You can use a pedal to control the volume level and effect application.

Connect an expression pedal to the **ASSIGNABLE PEDAL** jack. Also, use “Pedal Edit” on the **CONTROLLER** screen to specify that an expression pedal is assigned to the **ASSIGNABLE PEDAL** jack.

**IMPORTANT!**

- Use a commercially available expression pedal that meets the specifications below.\* Note that the polarity of the pedals of some manufacturers is different from the polarity required by this Digital Piano.

\* Operation has been verified for the pedals below.

- Roland EV-5
- KURZWEIL CC-1
- FATAR VP-25, VP-26



**Pedal Connector**

You can connect the optionally available 3-Pedal Unit (SP-33) to the pedal connector on the bottom of the Digital Piano. You can then use the pedals for expression that is similar to that available on an acoustic piano.

**Bottom**

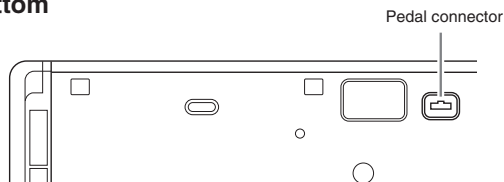

**NOTE**

- The optionally available CS-67P special stand is required in order to use the SP-33 Pedal Unit.

**Connecting Audio Equipment or an Amplifier**

You can connect audio equipment or a music amplifier to the Digital Piano and then play through external speakers for more powerful volume and better sound quality.

**IMPORTANT!**

- While sound output from the speakers is disabled,\* the Digital Piano automatically optimizes sound for headphones and **LINE OUT** listening. During speaker output, it automatically switches to optimization for listening with speakers.
  - \* Plug inserted into the **PHONES** jack or “Speaker” **SYSTEM SETTING** Screen (page EN-74) turned off.
- Whenever connecting a device to the Digital Piano, first use the **VOLUME** controller to set the volume to a low level. After connecting, you can adjust the volume to the level you want.
- Whenever you connect any device to the Digital Piano, be sure to read the user documentation that comes with the device.

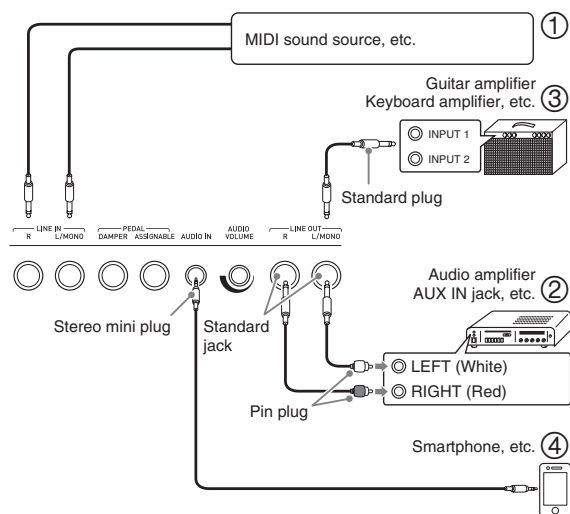

## Using the Digital Piano to Produce Sounds from an External Source (Figures ① and ④)

An external source connected to **LINE IN R** (right) is output from the Digital Piano's right speaker, while a source connected to **LINE IN L/MONO** is output from the left speaker. Use commercially available connection cords that match the equipment being connected to. When an external source is connected to **LINE IN L/MONO** only, the input is output from both speakers. You can connect a smartphone or other music player to **AUDIO IN**.

Use the **AUDIO VOLUME** knob to adjust the volume level from a smartphone. Volume from a smartphone cannot be adjusted using the **2 VOLUME** knob.

### NOTE

- Digital Piano built-in effects (reverb, chorus, DSP) are also applied to **LINE IN** terminal input. **LINE IN** input can be recorded with the Audio Recorder.
- Digital Piano built-in effects (reverb, chorus, DSP) are not applied to **AUDIO IN** terminal input. **AUDIO IN** input cannot be recorded with the Audio Recorder.

## Connecting to Audio Equipment (Figure ②)

Use commercially available cables to connect the external audio equipment to the Digital Piano's **LINE OUT** jacks as shown in Figure ②. **LINE OUT R** jack output is right channel sound, while **LINE OUT L/MONO** jack output is left channel sound. It is up to you to purchase connecting cables like the ones shown in the illustration for connection of audio equipment. Normally in this configuration you must set the audio equipment's input selector to the setting that specifies the terminal (such as **AUX IN**) to which the Digital Piano is connected. Use the Digital Piano's **VOLUME** controller to adjust the volume level.

## Connecting to a Musical Instrument Amplifier (Figure ③)

Use commercially available cables to connect the amplifier to the Digital Piano's **LINE OUT** jacks as shown in Figure ③. **LINE OUT R** jack output is right channel sound, while **LINE OUT L/MONO** jack output is left channel sound. Connecting to the **LINE OUT L/MONO** jack only outputs a mixture of both channels. It is up to you to purchase a connecting cable like the one shown in the illustration for connection of the amplifier. Use the Digital Piano's **VOLUME** controller to adjust the volume level.

### IMPORTANT!

- When using the **LINE OUT** jack, insert a plug or turn off the "Speaker" setting on the **SYSTEM SETTING** Screen (page EN-74). This will switch to a timbre suitable for line out.

## Bundled and Optional Accessories

Use only accessories that are specified for use with this Digital Piano.

Use of unauthorized accessories creates the risk of fire, electric shock, and personal injury.

### NOTE

- You can get information about accessories that are sold separately for this product from the **CASIO** catalog available from your retailer, and from the **CASIO** website at the following URL.  
<http://world.casio.com/>

# Operations Common to All Modes

## Using the Display Screen

### Display Screen Layout

When you turn on the Digital Piano, a MENU screen and a MAIN screen (which shows the current setup) appear on the display. You can use these screens to configure a variety of different functions. A quick palette of navigation icons along the right side of the display are for navigating between screens.

#### ■ MENU screen

Touching a menu icon displays a screen for configuring tone, rhythm, and other settings.

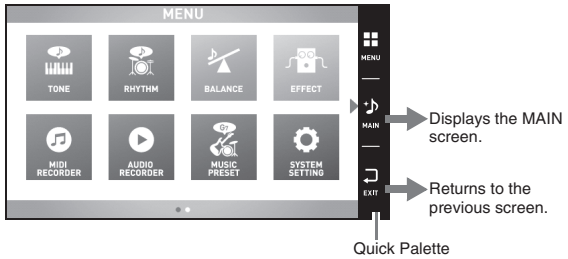

#### ■ MAIN screen

The MAIN screen is for checking and modifying main settings. Current settings are shown along the bottom of the screen.

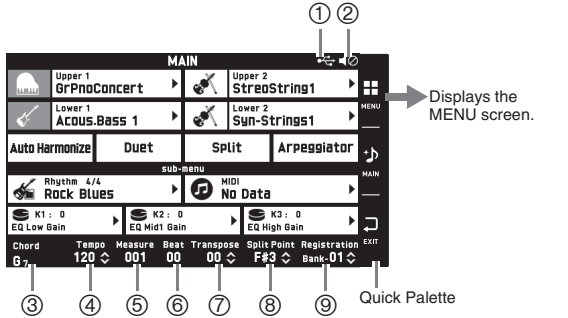

- ① USB flash drive mounted
- ② Speakers off
- ③ Chord
- ④ Tempo
- ⑤ Measure
- ⑥ Beat
- ⑦ Transpose
- ⑧ Split point
- ⑨ Registration bank

#### ■ Quick Palette

The Quick Palette is always displayed along the right side of the screen. Touch the Quick Palette icons to navigate between screens.

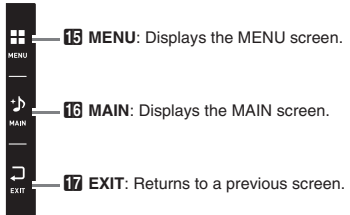

### Screen Contents

You can tell the currently selected items and operation enabled icons by their colors;  
 Red: Currently selected or turned on  
 Blue: Operation enabled

Example: "Soft Rock" selected in the Rock group.

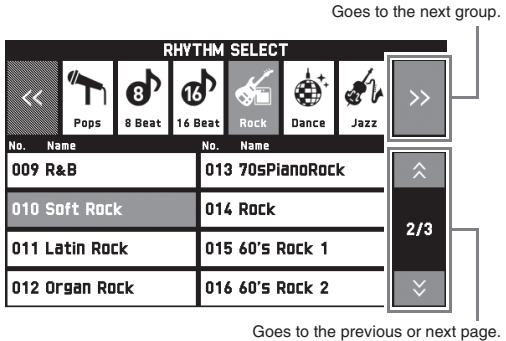

#### ! IMPORTANT!

- The meanings of symbols that appear after data is recorded or edited are explained below.
  - ! : Unsaved data
  - \*: Saved data
 Unsaved data (!) will be discarded if you exit the editing or recording operation by selecting a different number. If you do not want saved or edited data to be discarded, be sure to save it before doing anything else.

## Performing Operations

### To use the touch panel

Your Digital Piano has a touch panel. You can use the touch panel to configure a variety of different functions.

#### ! IMPORTANT!

- Do not perform touch panel operations with a sharp or hard pointed object. Doing so can damage the LCD.

#### Touch

Press the display lightly with your finger.

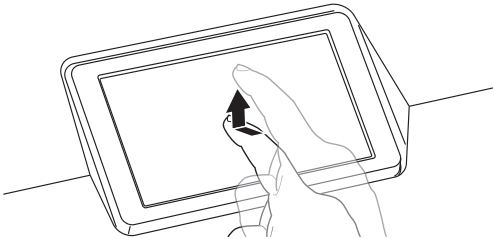

#### Swipe

Swipe the display from left to right with your finger. Swiping a MENU screen changes to another page of menu items.

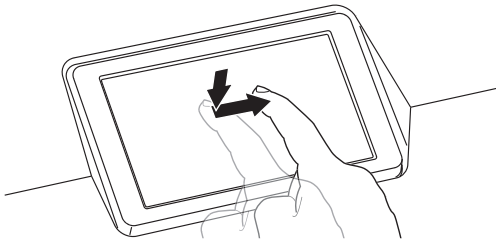

### To input text characters

You can touch the keys of an on-screen touch keyboard to input data file names. The Digital Piano supports input of alpha characters and symbols.

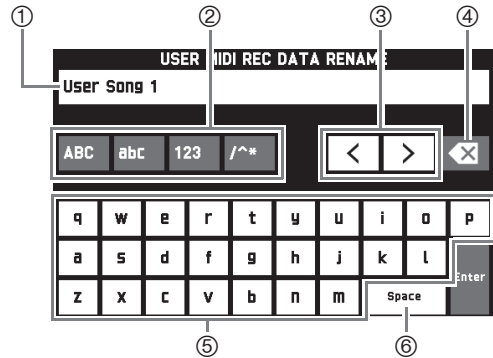

- Shows the letters you input.
- Selects the character type.
- Moves the cursor forward and back.
- Deletes the letter to the left at the cursor.
- Input letters at the cursor position.
- Inputs a space at the cursor position.

## To select an item in a list

An item that can be selected using a list is indicated by the “▶” icon.

1. Touch the item whose setting you want to change.

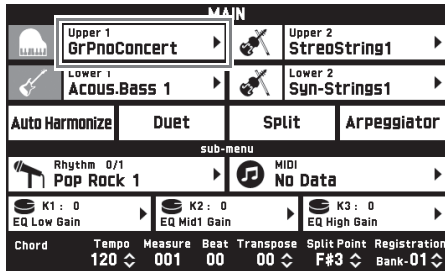

2. On the list that appears, touch the item to which you want to change.

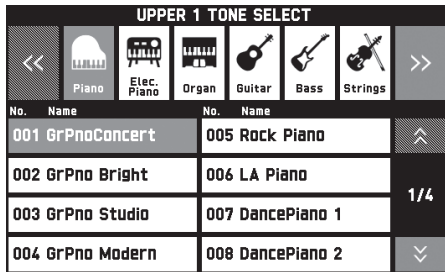

## To change a setting value

A setting value that can be changed is indicated by a “◊” icon.

1. Touch the item whose setting you want to change.

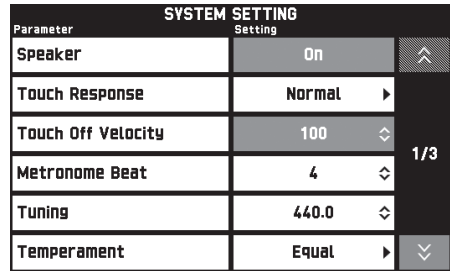

2. Use the **18** Dial or the **19** ▼, ▲ buttons to change setting value.

- Holding down either of the **19** ▼, ▲ buttons scrolls through values at high speed.

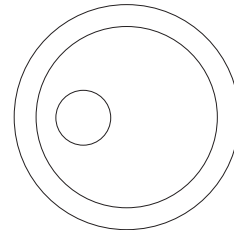

## To toggle a function on or off

To toggle a function between on or off, touch its item or icon.

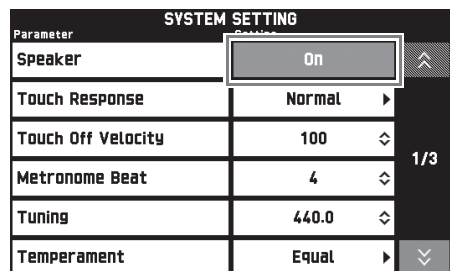

# Playing with Different Tones

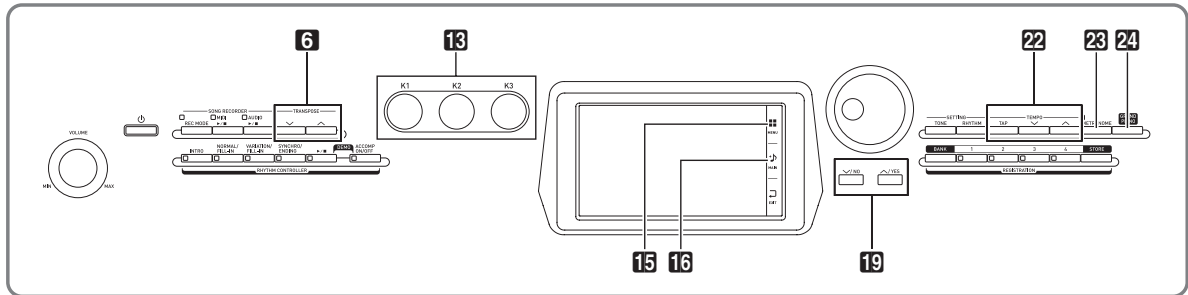

## Selecting and Playing a Tone

Your Digital Piano has 650 tones. Tones are divided into 13 groups.

- Refer to the separate Appendix for details.

1. On the screen, touch **16 MAIN**.

This displays the MAIN screen.

2. Touch the “Upper 1” tone.

This displays the TONE SELECT screen.

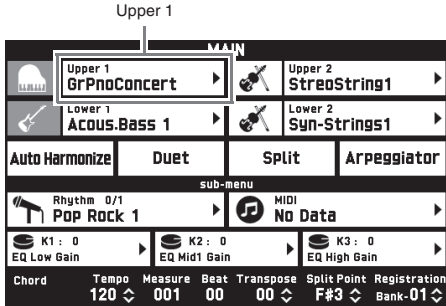

3. Touch the group that contains the tone you want to use.

- You can navigate between groups by touching “<<” or “>>”.

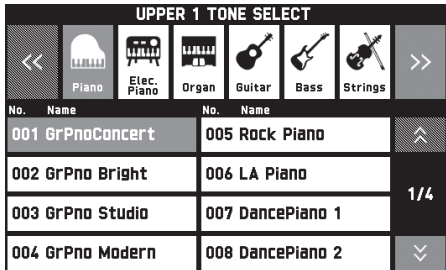

4. Touch the tone you want to use.

- You can navigate between tone list pages by touching “^” or “v”.

5. On the screen, touch **16 MAIN** to return to the MAIN screen.

**NOTE**

- Touching the Upper 1 icon to turn it off will deselect the keyboard tone so nothing will sound on the keyboard.
- Pressing the **24 GRAND PIANO** button will switch to the grand piano tone and reconfigure Digital Piano settings so they are optimized for grand piano play. Refer to the separate Appendix for details.



## Splitting the Keyboard between Two Tones

You can split the keyboard so the left side (lower range) plays one tone and the right side (upper range) plays a different tone.

- On a split keyboard, a tone assigned to the low range is called a “split tone” (Lower 1).

*Example:* When “GM Slap Bass 1” is selected as the split tone

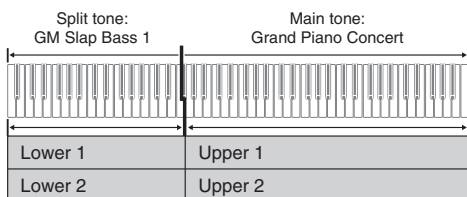

1. On the screen, touch **16** MAIN.

This displays the MAIN screen.

2. Select the main tone.

3. On the MAIN screen, touch “Split”.

This turns on split.

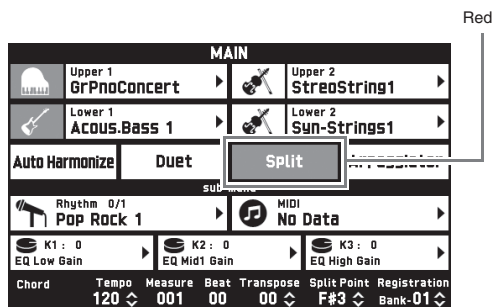

4. Touch “Lower 1”.

This displays the TONE SELECT screen.

5. Touch the group that contains the tone you want to use as the split tone.

6. Touch the tone you want to use as the split tone.

7. On the screen, touch **16** MAIN to return to the MAIN screen.

8. To unsplit the keyboard and return it to a single tone, touch “Split” on the MAIN screen.

This unsplit the keyboard.

### NOTE

- You can layer both the main tone and the split tone with another by turning on layer (page EN-17). You can also configure the layer setting after turning on the split.
- Turning off Upper 1, Upper 2, Lower 1, or Lower 2 by touching its icon will mute the applicable tone.
- When tones with DSP are assigned as both the main tone and the split tone, the effect of one of the tones becomes disabled.

### To move the keyboard split point

You can use the procedure below to specify the location on the keyboard where it splits between the left side and the right side. That location is called the “split point”.

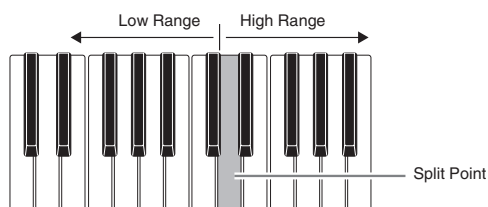

1. On the screen, touch **16** MAIN.

This displays the MAIN screen.

2. Touch “Split Point”.

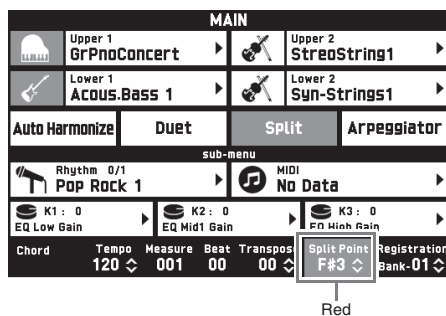

3. Use the **19**  $\nabla$ ,  $\blacktriangle$  buttons to specify the split point, which is the leftmost key of the upper range.

- You can also specify the split point by touching and holding “Split Point” as you press the desired keyboard key.

## Layering Two Tones

You can layer two different tones so they play at the same time when you press a keyboard key.

- The Upper 1 tone is called the “main tone”, while the Upper 2 tone is called the “layered tone”.

### 1. On the screen, touch **16** MAIN.

This displays the MAIN screen.

### 2. Select the main tone.

### 3. Touch the Upper 2 icon.

This turns on layer and layers the two tones.

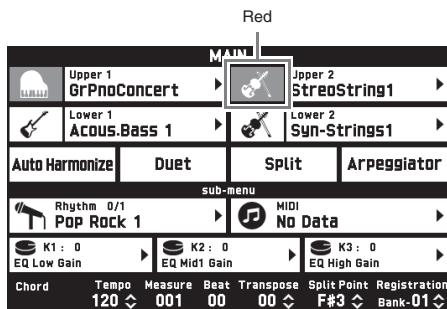

### 4. Touch the “Upper 2” tone.

This displays the TONE SELECT screen.

### 5. Touch the group that contains the tone you want to use as the layer tone.

### 6. Touch the tone you want to use as the layer tone.

### 7. On the screen, touch **16** MAIN to return to the MAIN screen.

### 8. To unlayer the keyboard and return to a single tone, touch the Upper 2 icon on the MAIN screen.

This unlayers the tones.

#### NOTE

- You can adjust the balance between the main tone and layered tone. See “Adjusting the Keyboard Volume Balance” (page EN-19).
- Touching the Upper 1 or Upper 2 icon will turn off the applicable tone so it does not sound.
- When tones with DSP are assigned as both the main tone and the layered tone, the effect of one of the tones becomes disabled.

## Splitting the Keyboard for Duet Play

You can split the keyboard in the center for duet play so the left and right sides have the same ranges. The left outer pedal operates as the left side damper pedal, while the right outer pedal is the right side damper pedal.

The duet play can be used with the teacher showing how to play on the left side as the student plays the same melody on the right side.

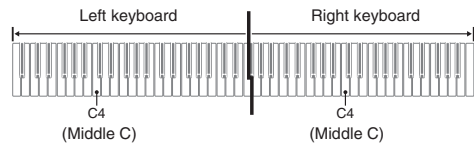

### Pedals

#### ● Using the Optional SP-33 Pedal Unit

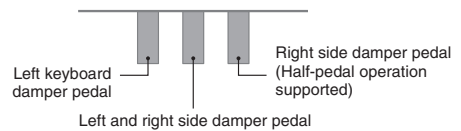

#### ● Using the Provided SP-3 Pedal Unit

For use as the right keyboard damper pedal, connect to the **DAMPER PEDAL** terminal.

For use as the left keyboard damper pedal, connect to the **ASSIGNABLE PEDAL** terminal.

### 1. On the screen, touch **16** MAIN.

This displays the MAIN screen.

## 2. Touch “Duet”.

This turns on duet play.

- Touch “Pan” to turn on Duet Pan. While Duet Pan is enabled (on), the left side keyboard tone is output from the left speaker, while the right side keyboard tone is output from the right speaker. The effects below are not applied.
  - Acoustic Simulator (except for Hammer Response)
  - Reverb
  - Delay
  - Chorus
  - DSP

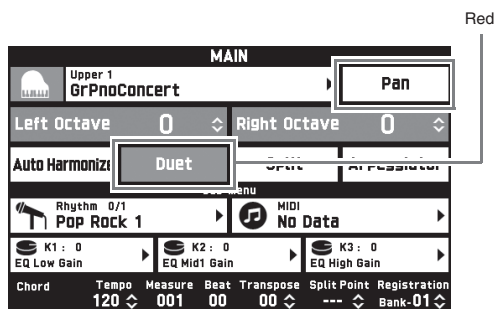

## 3. To turn off duet play, touch “Duet” again.

This returns to the state in effect before you turned on duet play.

## To change the octave of a Duet Mode keyboard (Duet Octave Shift)

You can use the following procedure to change the octave of the left and right Duet Mode keyboards.

1. Perform steps 1 and 2 of the procedure under “Splitting the Keyboard for Duet Play”.
2. Touch “Left Octave” and then use the **19**  $\downarrow$ ,  $\uparrow$  buttons to change the octave of the left keyboard.

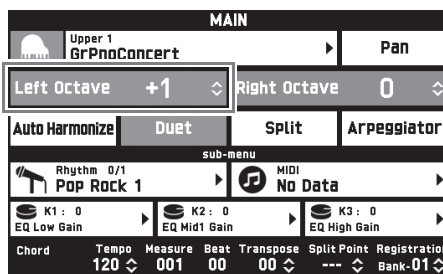

*Example:* The illustration below shows how changing the left octave shift setting to “+1” affects the left keyboard octave.

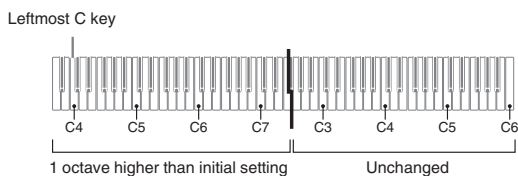

3. Touch “Right Octave” and then use the **19**  $\downarrow$ ,  $\uparrow$  buttons to change the octave of the right keyboard.

### NOTE

- Turning off duet play clears octave shift settings and returns the keyboard to its initial default octave settings.

## Adjusting the Keyboard Volume Balance

Use this procedure to adjust the volume balance between the main tone and the layered tone.

1. On the screen, touch **15 MENU**.  
This displays the MENU screen.
2. Touch “BALANCE”.
3. Touch the tone you want to adjust and then use the **19**  $\nabla$ ,  $\wedge$  buttons to adjust volume.  
Upper 1: Main tone  
Upper 2: Layered tone  
Lower 1: Split (main) tone  
Lower 2: Split (layered) tone
4. On the screen, touch **16 MAIN** to return to the MAIN screen.

### NOTE

- For other BALANCE screen settings, see “BALANCE Screen” under “Configuring Digital Piano Settings” (pages EN-68 through EN-81).

## Using the Metronome

1. Press the **23 METRONOME** button.  
This starts the metronome.

Flashes in time with the beat.

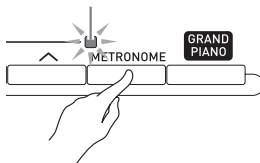

2. Press the **23 METRONOME** button again to stop the metronome.  
This stops the metronome.

## To change the beats per measure

You can specify from 0 to nine beats per measure for the metronome.

Specifying 0 will cause each beat to be indicated by the same sound. This setting lets you practice with a steady beat.

1. On the MENU screen, touch “SYSTEM SETTING”.
2. Touch “Metronome Count”.
3. Use the **19**  $\nabla$ ,  $\wedge$  buttons to select a beats per measure value.
4. On the screen, touch **16 MAIN**.  
This returns to the MAIN screen.

## Adjusting the Balance between Metronome and Keyboard Volume (Metronome Volume)

You can use the following procedure to adjust the volume level of the metronome, without affecting the volume of keyboard output.

1. On the screen, touch **15 MENU**.  
This displays the MENU screen.
2. Touch “BALANCE”.
3. Touch “Metronome Volume”.
4. Use the **19**  $\nabla$ ,  $\wedge$  buttons to adjust the metronome volume setting (0 to 127).
5. On the screen, touch **16 MAIN**.  
This returns to the MAIN screen.

## Changing the Tempo Setting

There are two different methods you can use to change the tempo setting: using the **22** TEMPO  $\nabla$ ,  $\blacktriangle$  buttons for gradual change, or by tapping a beat with the **22** TEMPO TAP button (tap input).

### Method 1:

To adjust the tempo setting using the **22** TEMPO  $\nabla$ ,  $\blacktriangle$  buttons

1. Use the **22** TEMPO  $\nabla$ ,  $\blacktriangle$  buttons to adjust the tempo setting.

Each press of a button increases or decreases the tempo value (beats per minute) by one.

- Holding down either button changes the value at high speed.
- You can specify a tempo value in the range of 20 to 255.

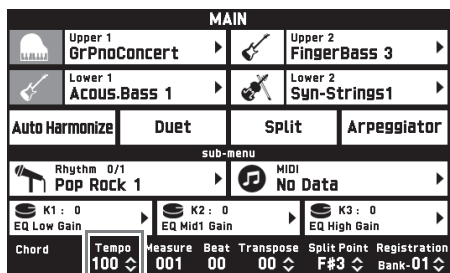

### Method 2:

To adjust the tempo by tapping a beat (tap input)

1. Tap the **22** TEMPO TAP button a number of times at the tempo you want to set.

- The tempo setting will change in accordance with your tapping.

Tap two or more times.

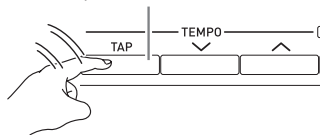

- After you use this method to specify the approximate tempo, you can then use the procedure under "To adjust the tempo setting using the **22** TEMPO  $\nabla$ ,  $\blacktriangle$  buttons" to adjust the setting to a more exact value.

## Using the Pitch Bend Wheel

You can use the pitch bend wheel to slide the pitch of notes smoothly upwards and downwards. This capability makes it possible to reproduce saxophone and electric guitar choking effects.

1. While playing a note on the keyboard, rotate the **32** PITCH BEND wheel on the left of the keyboard upwards or downwards.

The amount the note bends depends on how much you rotate the pitch bend wheel.

- Do not touch the pitch bend wheel as you turn on the Digital Piano.



### NOTE

- You also can configure pitch bend wheel operation by specifying the amount of pitch change at maximum rotation in either direction. See "CONTROLLER Screen" (page EN-76) for more information.

## Modifying Notes with the Modulation Wheel and Knobs

You can modify notes even while you are playing. Each tone is preset with effects that are appropriate for it.

1. While playing on the keyboard with your right hand, use your left hand to operate the **33** MODULATION wheel or the **13** knobs (K1 through K3).

The amount effect applied depends on how much the applicable control is moved.

- Do not touch the wheel or knobs as you turn on the Digital Piano.

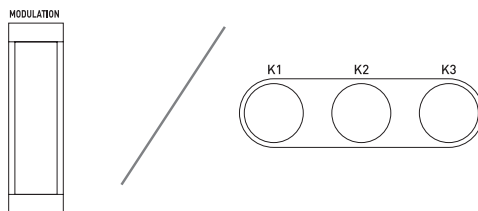

### NOTE

- You can change the effects and functions assigned to the modulation wheel and knobs. See "CONTROLLER Screen" under "Configuring Digital Piano Settings" (pages EN-68 through EN-81).

## To change a function assigned to a knob

1. On the screen, touch **16 MAIN**.  
This displays the MAIN screen.
2. On the MAIN screen, touch the knob whose setting you want to change.

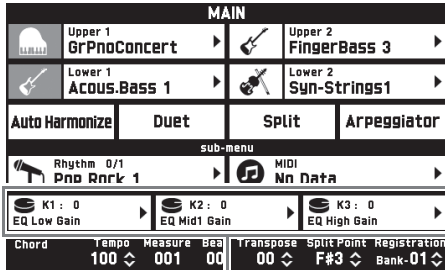

Current setting, Assigned target

3. Change the setting.

For detailed information about settings, see “CONTROLLER Screen” under “Configuring Digital Piano Settings” (pages EN-68 through EN-81).

### NOTE

- Two targets can be assigned to a knob. When there are two targets assigned to a knob, the display shows the first target and its setting.
- When there is a control change (CC) or other MIDI message that can be assigned to each part assigned to the first target, the display shows the setting of Part 1.

## Shifting the Pitch of the Digital Piano in Semitone Units (Transpose)

The transpose feature lets you raise or lower the overall pitch of the Digital Piano in semitone steps. You can use this feature to adjust keyboard tuning to a key that better matches a vocalist, another musical instrument, etc.

1. Use the **6 TRANSPOSE**  $\nabla$ ,  $\blacktriangle$  buttons to change the setting value.
  - You can change the tuning of the keyboard within the range of -12 to 00 to +12.
  - Pressing the **6 TRANSPOSE**  $\nabla$ ,  $\blacktriangle$  buttons at the same time changes the setting to 0.
  - The current transpose setting is shown on the MAIN screen.

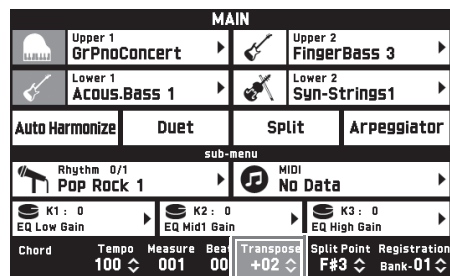

## Sounding Arpeggio Phrases Automatically (Arpeggiator)

With the arpeggiator, you can play various arpeggios and other phrases automatically by simply pressing keys on the keyboard. You can select from a number of different arpeggio options, including playing arpeggios from a chord, playing various phrases automatically, and more.

1. On the MENU screen, touch “ARPEGGIATOR”.

This displays the ARPEGGIATOR screen.

2. To enable the arpeggiator, touch “”.

- You can also toggle the arpeggiator between on and off by touching “Arpeggiator” on the MAIN screen.

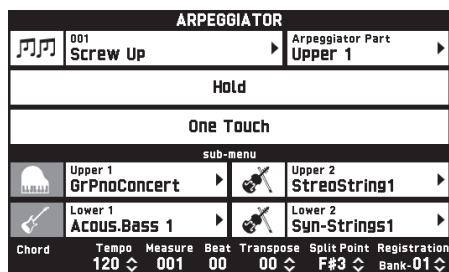

3. Touch the displayed arpeggio name.

4. Touch the arpeggiator type you want to use.

5. Configure arpeggiator settings as required.

Item	Description	Setting
Arpeggiator Part	While split is turned on, you can specify either Upper or Lower as the keyboard that plays the arpeggio.	Upper All, Upper 1, Upper 2, Lower All, Lower 1, Lower 2
Hold	ON: The arpeggio will continue to play even after keyboard keys are released. OFF: The arpeggio will play while keyboard keys are pressed.	
One Touch	Touching “One Touch” automatically selects the tone recommended for the currently selected arpeggiator type. That tone is assigned to the part selected with Arpeggiator Part.	

6. On the keyboard, play a chord or a single note.

Arpeggio is played in accordance with the currently selected arpeggiator type and the note(s) you play.

7. To disable the arpeggiator, touch “”.

# Editing a Tone

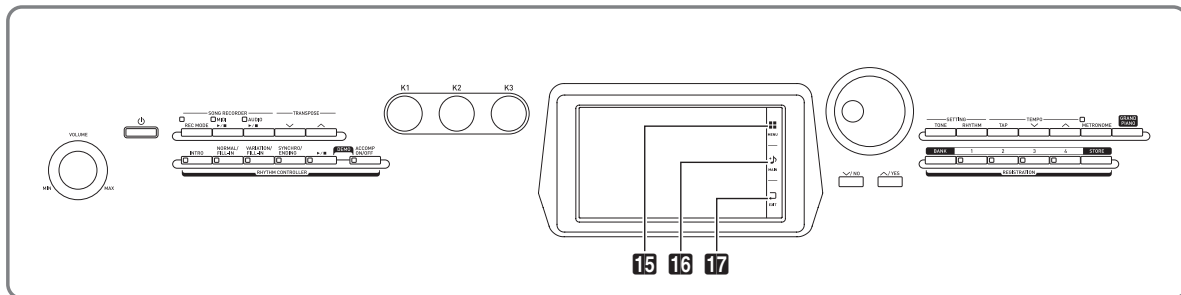

You can use the procedures below to edit tones and apply effects to the desired Upper 1 (main) tone.

## Editing a Tone

1. Specify Upper 1 as the tone to be edited.
2. Touch **15** MENU.
3. On the MENU screen, touch “TONE”.
4. Touch “Edit”.
5. Touch “Edit”.  
This displays the editing screen.
6. Touch the item whose setting you want to change.
  - The setting items that appear on the editing screen depend on the tone you select.
  - For information about editable parameters, see the explanations about each tone category table from “Editable Melody Tone Parameters” (page EN-25) through “Editable Hex Layer Tone Parameters” (page EN-30).
7. Change parameter settings as desired.
8. After you finish with your edits, press **17** EXIT.
9. After editing everything you want, touch “Write”.
10. Touch “Rename”.
11. Input a name for the tone.
12. After inputting the tone name, touch “Enter”.

13. Touch the destination tone number.

- If the tone number already has data assigned to it, there will be an asterisk (\*) next to it.

14. Touch “Execute”.

If the selected preset number does not have any data assigned to it, the message “Sure?” will appear. If it does have data assigned to it, the message “Replace?” will appear.

15. Touch “Yes”.

This stores the data.

- To return to the screen in step 13 without saving, touch “No”.



## Changing the Name of a Tone

1. On the MENU screen, touch “TONE”.
2. Touch “Edit”.
3. Touch “Rename”.
4. Touch the tone you want to rename.
5. Input the new name.
6. After you are finished inputting the name, touch “Enter”.

## Deleting a Tone

1. On the MENU screen, touch “Edit”.
2. Touch “Edit”.
3. Touch “Clear”.
4. Touch the tone you want to delete.
5. Touch “Execute”.
6. Touch “Yes”.
  - To cancel the delete operation, touch “No”.







## Editable Parameters

- Shaded cells indicate a group made up of multiple setting items. Touching "Enter" displays the setting items of a group.

### ■ Editable Melody Tone Parameters

Display Text	Description	Settings
Pitch	Pitch envelope. The editable parameters in this group affect the pitch of notes.	
Octave Shift	Octave shift. Changes the tone of notes in octave units.	-2 to 0 to +2
Envelope	<ul style="list-style-type: none"> <li>The figure below also applied to filter, amp, and other envelopes. With the pitch envelope, the pitch of the sound corresponds to the vertical (Level) axis.</li> <li>With a hex layer tone envelope, Decay Time can be divided into three parts and Release Time can be divided into two parts and edited.</li> <li>When Decay Level 3 is reached during key release note on, an immediate transition is made to Release Level 1 without sustain.</li> <li>The setting ranges of the parameters below are relative changes (relative to the presets of the tone) in the case of melody tones and drum tones. When editing a hex layer tone, they are absolute changes that have no relation to the presets of the tone. <ul style="list-style-type: none"> <li>Time and level of each envelope</li> <li>Rate, depth, delay, rise, modulation depth of LFO (page EN-27)</li> </ul> </li> </ul> <p>IL : Initial Level                      RT : Release Time  AT : Attack Time                      (RT1: Release Time 1)  AL : Attack Level                      (RT2: Release Time 2)  DT : Decay Time                      RL : Release Level  (DT1: Decay Time 1)                      (RL1: Release Level 1)  (DT2: Decay Time 2)                      (RL2: Release Level 2)  (DT3: Decay Time 3)  DL : Decay Level  (DL1: Decay Level 1)  (DL2: Decay Level 2)  (DL3: Decay Level 3)</p>	
Initial Level	Initial level. Pitch of the sound at initial note on.	-64 to 0 to +63
Attack Time	Attack time. Time it takes until the attack level is reached from the initial level.	-64 to 0 to +63
Release Time	Release time. Time it takes to reach Release Level after a key is released.	-64 to 0 to +63
Release Level	Release level. Target level reached immediately after a key is released.	-64 to 0 to +63
Stretch Tune	Stretch tuning. Sharpens high notes and flattens low notes to achieve characteristic piano stretch tuning. Turn off this setting to play with normal (non-stretch) tuning.	Off, Piano1, Piano2, Piano3, Piano4, Piano5, E.Piano1, E.Piano2

Display Text	Description	Settings
Filter	Filter. This is a group of editable parameters associated with filters (tones). <ul style="list-style-type: none"> <li>With this group, the vertical (Level) axis in the pitch envelope diagram corresponds to how the filter is applied.</li> </ul>	
Cutoff	Cutoff frequency. Specifies the filter cutoff frequency.	-64 to 0 to +63
Resonance	Resonance. Specifies the resonance of the tone in the vicinity of the cutoff frequency.	-64 to 0 to +63
Velocity Sense	Velocity sense. Specifies the degree of change in the filter in accordance with change in keyboard playing touch.	-64 to 0 to +63
Envelope	<ul style="list-style-type: none"> <li>For details about the parameters below, see "Pitch Envelope". Initial Level, Attack Time, Release Time, Release Level</li> </ul>	
Envelope Depth	Envelope depth. Specifies how the envelope is applied.	0 to 127
Attack Level	Attack level. Target level reached immediately after note on.	-64 to 0 to +63
Decay Time	Decay time. Time it takes for the sound to reach the decay level from the attack level.	-64 to 0 to +63
Decay Level	Decay level. Level the sound is sustained as long as a key or pedal is depressed.	-64 to 0 to +63
Amp	Amp. This is a group of editable parameters associated with the amp (volume).	
Volume	Volume. Specifies the amp volume.	0 to 127
Velocity Sense	Velocity sense. Specifies the degree of change in volume in accordance with change in keyboard playing touch.	-64 to 0 to +63
Envelope	<ul style="list-style-type: none"> <li>The vertical (Level) axis in the pitch envelope diagram corresponds to the volume in the case of this group.</li> <li>For details about the parameters below, see "Pitch Envelope". Initial Level, Attack Time, Release Time</li> <li>For details about the setting items below, see "Filter", above. Attack Level, Decay Time, Decay Level</li> </ul>	
Effect	Effect. This is a group of editable effect function parameters. For more information, see "EFFECT Screen" (page EN-71).	
DSP	DSP edit. This is a group of editable effect function DSPs (page EN-34). Touching "ENTER" displays the DSP editing screen.	
Reverb Send	Reverb send. Specifies how reverb (page EN-71) is applied to a tone.	0 to 127
Chorus Send	Chorus send. Specifies how chorus (page EN-71) is applied to a tone.	0 to 127
Delay Send	Delay send. Specifies how delay (page EN-71) is applied to a tone.	0 to 127

Display Text	Description	Settings
LFO	Low Frequency Oscillator. This is a group of editable LFO parameters applied to pitch, filter, and amp.	
Pitch Wave FilterAmpWave	Wave type. Specifies one of the following wave types to be used for LFO. FilterAmpWave is shared by filter and amp.  <div style="display: flex; justify-content: space-around;"> <div style="text-align: center;"> <p>Sin (sine wave)</p>  </div> <div style="text-align: center;"> <p>Puls 1:3 (square wave 1:3)</p>  </div> </div> <div style="display: flex; justify-content: space-around;"> <div style="text-align: center;"> <p>Tri (triangle wave)</p>  </div> <div style="text-align: center;"> <p>Puls 2:2 (square wave 2:2)</p>  </div> </div> <div style="display: flex; justify-content: space-around;"> <div style="text-align: center;"> <p>Saw up (sawtooth up wave)</p>  </div> <div style="text-align: center;"> <p>Puls 3:1 (square wave 3:1)</p>  </div> </div> <div style="display: flex; justify-content: space-around;"> <div style="text-align: center;"> <p>Saw down (sawtooth down wave)</p>  </div> </div>	Refer to the cell to the left.
Pitch Rate FilterAmpRate	Rate. LFO speed (frequency). FilterAmpRate is shared by filter and amp.	-64 to 0 to +63
Pitch Depth Filter Depth Amp Depth	Depth. Specifies how LFO is applied.	-64 to 0 to +63
Pitch Delay Filter Delay Amp Delay	Delay. Specifies the degree of delay in the timing for applying LFO.	-64 to 0 to +63
Pitch Rise Filter Rise Amp Rise	Rise. Specifies the time it takes from the start of application of the LFO until the effect reaches the level specified by Depth, above.	-64 to 0 to +63
Pitch Mod.Depth Filter Mod.Depth Amp Mod.Depth	Modulation depth. Specifies how modulation is applied to the LFO.	-64 to 0 to +63
Portamento	Portamento. This is a group of editable portamento parameters.	
Portamento On/Off	Portamento On/Off. Select "On" for a smooth glide from one tone to the next, or "Off" when a smooth glide is not required.	Off, On
Portamento Time	Time. Specify the length of time for the tone change.	0 to 127
Pan	Pan. This is a group of editable parameters associated with pan (sound stereo position) operation.	
Dynamic Panning	Dynamic panning. To reflect changes in part panning in the sound being produced, select "On" for this setting. Select "Off" if you do not want changes reflected.	Off, On
Pan Position	Panning position. Select "PreDSP" to apply panning before the DSP, or "PostDSP" to apply panning after the DSP.	PreDSP, PostDSP

## ■ Editable Drum Tone Parameters

Display Text	Description	Settings
Inst Edit	Instrument edit. This is a group of editable instruments assigned to each keyboard. <ul style="list-style-type: none"> <li>Press a keyboard key to specify the key to be edited.</li> </ul>	C-1 - G9
Inst Select	Instrument number select. Specifies the number of the drum tone assigned to each key.	See the “Instrument List” in the separate Appendix.
Note Off Mode	Note off mode. Turning on this setting causes note off to be performed when a key is released.	Off, On
Assign Group	Assign group. Specifies as a value from 1 to 15 which group the currently selected key should be placed into. Only one keyboard in a group is sounded at any time (non-polyphonic).	Off, 1 to 15
Pitch	Pitch envelope. For details, see the melody tone “Pitch Envelope” (page EN-25). <ul style="list-style-type: none"> <li>For details about the setting items below, see the melody tone “Pitch Envelope” (page EN-25). Initial Level, Attack Time</li> </ul>	
Coarse Tune	Coarse tune. Changes the pitch of notes by semitone units.	-24 to 0 to +24
Fine Tune	Fine tune. Fine tunes the pitch of the sound. Lowers the value up to -256 or raises the value up to +255 in semitone steps.	-256 to 0 to +255
Filter	Filter. For details, see the melody tone “Filter” (page EN-26). <ul style="list-style-type: none"> <li>For details about the setting items below, see the melody tone “Filter” (page EN-26). Cutoff, Resonance, Envelope Depth, Attack Level, Decay Time, Decay Level</li> <li>For details about the setting items below, see the melody tone “Pitch Envelope” (page EN-25). Initial Level, Attack Time</li> </ul>	
Amp	Amp. For details, see the melody tone “Amp” (page EN-26). <ul style="list-style-type: none"> <li>For details about the setting items below, see the melody tone “Amp” (page EN-26). Volume</li> <li>For details about the setting items below, see the melody tone “Pitch Envelope” (page EN-25). Initial Level, Attack Time</li> <li>For details about the setting items below, see the melody tone “Filter” (page EN-26). Attack Level, Decay Time, Decay Level</li> </ul>	
Pan	Pan. Controls whether the sound of the part can be heard from the left side or right side.	-64 to +63
Effect	Effect. This is a group of editable effect function parameters. <ul style="list-style-type: none"> <li>For details about the setting items below, see the melody tone “Effect” (page EN-26). Chorus Send, Delay Send, Reverb Send</li> <li>Values produced by multiplying send values configured for instrument-specific effects (Effect) and send values configured for global effects (Effect) are sent to the system.</li> <li>When “DSP On/Off” is turned on (DSP applied), chorus, delay, and reverb settings can be configured within “Effect” below.</li> </ul>	
DSP On/Off	DSP on/off. Specifies whether or not DSP should be applied to tones.	Off, On

Display Text	Description	Settings
Effect	<p>Common effect. This is a group of editable effect function parameters. For details, see the melody tone “Effect” (page EN-26).</p> <ul style="list-style-type: none"><li>• For details about the setting items below, see the melody tone “Effect” (page EN-26). Chorus Send, Delay Send, Reverb Send</li></ul>	
Pan	<p>Pan. This is a group of editable parameters associated with pan (sound stereo position) operation.</p> <ul style="list-style-type: none"><li>• For details about the setting items below, see the melody tone “Pan” (page EN-27). Dynamic Panning, Pan Position</li></ul>	

## ■ Editable Hex Layer Tone Parameters

Display Name	Description	Settings
Volume	Volume. Overall hex layer volume.	0 to 127
Keyoff Velocity Mode	Key off velocity mode. Select “KeyOff” to use the key off velocity as the key off velocity, or “KeyOn” to select the key on velocity. Select “Both” to reflect both (key on and key off) velocities.	KeyOff, KeyOn, Both
Layer	Layer. This is a group of editable parameters for each layer. Touch the layer you want to edit and then modify setting items as required. <ul style="list-style-type: none"> <li>When “ALL” (all layers) is selected as the layer number, an x-mark may be displayed on the left side of the display showing the part being edited. This indicates that all of the layers do not have the same setting for the currently selected parameter.</li> </ul>	
Layer On/Off	Layer on/off. Selecting off disables layer.	Off, On
Wave Number	Wave number. Selects a wave type. Refer to the “Wave List” in the separate Appendix for information about wave types.	See “Wave List” in the separate Appendix.
Key Range Low	Key Range Low. Specifies the lower limit of the enabled keyboard range. Nothing sounds when any keyboard key below this range is pressed. <ul style="list-style-type: none"> <li>Touch a setting and then use the keyboard keys to change it.</li> </ul>	C-1 - G9
Key Range High	Key Range High. Specifies the upper limit of the enabled keyboard range. Nothing sounds when any keyboard key above this range is pressed. <ul style="list-style-type: none"> <li>Touch a setting and then use the keyboard keys to change it.</li> </ul>	C-1 - G9
Velocity Range Low	Velocity range low. Specifies the minimum value of the effective velocity. No sound is produced when playing at a velocity less than this setting.	0 to 127
Velocity Range High	Velocity range high. Specifies the maximum value of the effective velocity. No sound is produced when playing at a velocity greater than this setting.	0 to 127
Start Trigger	Start trigger. Specifies whether a note is sounded when a keyboard key is pressed (KeyOn) or when a keyboard key is released (KeyOff).	KeyOn, KeyOff
Pitch	Pitch envelope. For details, see the melody tone “Pitch Envelope” (page EN-25). <ul style="list-style-type: none"> <li>For details about the setting items below, see the melody tone “Pitch Envelope” (page EN-25). Octave Shift</li> <li>For details about the setting items below, see drum tone “Pitch Envelope” (page EN-28). Coarse Tune, Fine Tune</li> </ul>	
Envelope	<ul style="list-style-type: none"> <li>For details about the setting items below, see the melody tone “Pitch Envelope” (page EN-25). You can input “Initial Level”, “Attack Level”, and “Release Level” values in the range of -256 to 0 to +255. You can input “Attack Time”, “Decay Time”, and “Release Time” values in the range of 0 to 127. Initial Level, Attack Time, Release Time, Release Level</li> <li>For details about the setting items below, see the melody tone “Filter” (page EN-26). You can input “Attack Level” and “Decay Level” values in the range of -256 to 0 to +255. You can input a “Decay Time” in the range of 0 to 127. Attack Level, Decay Time, Decay Level</li> </ul>	
Key Follow	Key follow. Adjusts the amount of pitch change between neighboring keyboard keys. A higher value represents greater change.	-128 to 0 to +127
Key Follow Base	Key follow base. Keyboard key that is the center of key follow.	C-1 - G9
Split Shift	Split shift. Counting from the keyboard key that is pressed, the waveform that sounds is the one assigned to the keyboard key that is the specified split shift amount above or below the pressed key. The pitch used is the one that corresponds to the pressed keyboard key.	-12 to 0 to +12
LFO Layer Depth	LFO layer depth. Adjusts how LFO is applied to each layer.	0 to 127

Display Name	Description	Settings
Filter	Filter. For details, see the melody tone "Filter" (page EN-26). <ul style="list-style-type: none"> <li>For details about the setting items below, see the melody tone "Filter" (page EN-26). You can input a value in the range from 0 to 127. Cutoff, Resonance</li> </ul>	
Filter Type	Filter type. Specifies the range cut by the filter. LPF1: 6dB/oct filter for low-frequency band components. No resonance effect. Suitable for acoustic instruments. LPF2: 12dB/oct filter for low-frequency band components. No resonance effect. Suitable for acoustic instruments. LPF3: 12dB/oct filter for low-frequency band components. With resonance effect. Suitable for synthesized tones. BPF: 6dB/oct filter for band components in the vicinity of the cutoff frequency. With resonance effect. HPF: 12dB/oct filter for high-frequency band components. With resonance effect.	Refer to the cell to the left.
Velocity Sense	Velocity sense. Specifies the degree of change in the filter in accordance with keyboard press velocity.	-64 to 0 to +63
Envelope	<ul style="list-style-type: none"> <li>For details about the setting items below, see the melody tone "Filter" (page EN-26). You can input a value in the range from 0 to 127. Attack Level, Envelope Depth</li> <li>For details about the setting items below, see the melody tone "Pitch Envelope" (page EN-25). You can input a value in the range from 0 to 127. Initial Level, Attack Time</li> </ul>	
Decay 1 Time	Decay 1 time. Time it takes for the sound to reach the Decay 1 level from the attack level.	0 to 127
Decay 1 Level	Decay 1 level. Target level for change from the attack level up to the Decay 1 level.	0 to 127
Decay 2 Time	Decay 2 time. Time it takes for the sound to reach the Decay 2 level from the Decay 1 level.	0 to 127
Decay 2 Level	Decay 2 level. Second target level for change from Decay 1 level up to the Decay 2 level.	0 to 127
Decay 3 Time	Decay 3 time. Time it takes for the sound to reach the Decay 3 level from the Decay 2 level.	0 to 127
Decay 3 Level	Decay 3 level. Third target level for change from Decay 2 level up to the Decay 3 level.	0 to 127
Release 1 Time	Release 1 time. Time it takes to reach Release Level 1 after a key is released.	0 to 127
Release 1 Level	Release 1 level. Target level reached immediately after a key is released.	0 to 127
Release 2 Time	Release 2 time. Time it takes to reach Release Level 2 from Release Level 1.	0 to 127
Release 2 Level	Release 2 level. Second target level reached after a key is released.	0 to 127
Low Key Follow	Low key follow. Adjusts the amount of filter change between neighboring keyboard keys. A greater value represents greater change. A positive (+) value specifies a lower cut off frequency for the low-range keyboard.	-128 to 0 to +127
Low Key	Low Key. Applies the low key follow effect to the keys on the low range (left) side of the key specified by this setting.	C-1 - G9 (Low Key ≤ High Key)
High Key Follow	High key follow. Adjusts the amount of filter change between neighboring keyboard keys. A greater value represents greater change. A positive (+) value specifies a higher cut off frequency for the high-range keyboard.	-128 to 0 to +127
High Key	High key. Applies the high key follow effect to the keys on the high range (right) side of the key specified by this setting.	C-1 - G9 (Low Key ≤ High Key)
LFO Layer Depth	LFO layer depth. Adjusts how LFO is applied to each layer.	0 to 127

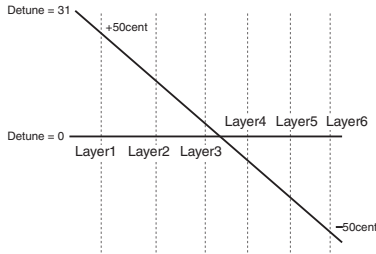

Display Name	Description	Settings
Amp	<p>Amp. For details, see the melody tone “Amp” (page EN-26).</p> <ul style="list-style-type: none"> <li>For details about the setting items below, see the melody tone “Amp” (page EN-26). Volume, Velocity Sense</li> <li>For details about the setting items below, see the drum sound “Amp” (page EN-28). Pan</li> </ul>	
Envelope	<ul style="list-style-type: none"> <li>For details about the setting items below, see the melody tone “Pitch Envelope” (page EN-26). You can input a value in the range from 0 to 127. Initial Level, Attack Time</li> <li>For details about the setting items below, see the melody tone “Filter” (page EN-26). You can input a value in the range from 0 to 127. Attack Level</li> <li>For details about the setting items below, see the hex layer “Filter” (page EN-31). Decay 1 Time, Decay 1 Level, Decay 2 Time, Decay 2 Level, Decay 3 Time, Decay 3 Level, Release 1 Time, Release 1 Level, Release 2 Time</li> </ul>	
Low Key Follow	Low key follow. Adjusts the amount of volume change between neighboring keyboard keys. A greater value represents greater change. A positive (+) value specifies a lower volume for the low-range keyboard.	-128 to 0 to +127
Low Key	Low Key. Applies the low key follow effect to the keys on the low range (left) side of the key specified by this setting.	C-1 - G9 (Low Key $\leq$ High Key)
High Key Follow	High key follow. Adjusts the amount of volume change between neighboring keyboard keys. A greater value represents greater change. A positive (+) value specifies a greater volume for the high-range keyboard.	-128 to 0 to +127
High Key	High key. Applies the high key follow effect to the keys on the high range (right) side of the key specified by this setting.	C-1 - G9 (Low Key $\leq$ High Key)
LFO Layer Depth	LFO layer depth. Adjusts how LFO is applied to each layer.	0 to 127
Effect	<p>For details, see the melody tone “Effect” (page EN-26).</p> <ul style="list-style-type: none"> <li>For details about the setting items below, see the drum tone “Effect” (page EN-28). DSP On/Off</li> <li>For details about the setting items below, see the melody tone “Effect” (page EN-26). Chorus Send, Delay Send, Reverb Send</li> <li>The send value set for the effect of each layer (Effect) is multiplied by the send value set for the overall instrument effect (Effect) and the results are batch sent to the system.</li> <li>When “DSP On/Off” is turned on (DSP applied), chorus, delay, and reverb settings can be configured within “Effect” below.</li> </ul>	

Display Name	Description	Settings
Pitch	Pitch. The editable parameters in this group affect the pitch of notes.	
Detune	<p>Detune. Causes the tuning of Layers 1 through 6 to be slightly different from each other. A larger setting value increases the amount of detuning. The maximum value (31) results in a difference of 100 cents (semitones) between Layer 1 and Layer 6.</p> 	0 to 31
Pitch Lock Layer 1&2 Pitch Lock Layer 3&4 Pitch Lock Layer 5&6	Pitch lock. When this setting is turned on for Layers 1 and 2, the Layer 2 pitch is changed to the same pitch as Layer 1 so both pitches are the same. The same is true for Layers 3 and 4, and Layers 5 and 6.	Off, On
Stretch Tune	For details, see the melody tone “Stretch Tune” (page EN-25).	
Effect	<p>Common effect. This is a group of editable effect function parameters. For details, see the melody tone “Effect” (page EN-26).</p> <ul style="list-style-type: none"> <li>For details about the setting items below, see the melody tone “Effect” (page EN-26). Chorus Send, Delay Send, Reverb Send</li> </ul>	
LFO	<p>Low Frequency Oscillator. This is a group of editable LFO parameters applied to the pitch of a layered tone. For details, see the melody tone “LFO” (page EN-27).</p> <ul style="list-style-type: none"> <li>For details about the setting items below, see the melody tone “LFO” (page EN-27). You can input a value in the range from 0 to 127. Pitch Rate, Pitch Delay, Pitch Rise, Pitch Mod.Depth, Filter Amp Rate, Filter Delay, Filter Rise, Filter Mod.Depth, Amp Delay, Amp Rise, Amp Mod.Depth</li> <li>For details about the setting items below, see the melody tone “LFO” (page EN-27). The setting range of each “Depth” is -128 to 0 to +127. Pitch Wave, FilterAmpWave, Pitch Depth, Filter Depth, Amp Depth</li> </ul>	
Portamento	<p>Portamento. This is a group of editable portamento parameters.</p> <ul style="list-style-type: none"> <li>For details about the setting items below, see the melody tone “Portamento” (page EN-27). Portamento On/Off, Portamento Time</li> </ul>	
Pan	<p>Pan. This is a group of editable parameters associated with pan (sound stereo position) operation. For details, see the melody tone “Pan” (page EN-27).</p> <ul style="list-style-type: none"> <li>For details about the setting items below, see the melody tone “Pan” (page EN-27). Dynamic Panning, Pan Position</li> </ul>	

## ■ Editable DSP Parameters

- Select “Through” if you want to disable application of DSP.

### --: Through

Select this option if you do not want to apply a DSP effect. There are no parameters that can be set while this option is selected.

### 01: Equalizer

This is a three-band equalizer.

#### Parameter Value Ranges:

- 1 :EQ1 Frequency (1.0k, 1.3k, 1.6k, 2.0k, 2.5k, 3.2k, 4.0k, 5.0k [Hz])  
Adjusts the center frequency of Equalizer 1.
- 2 :EQ1 Gain (-12 to 0 to +12)  
Adjusts the gain of Equalizer 1.
- 3 :EQ2 Frequency (1.0k, 1.3k, 1.6k, 2.0k, 2.5k, 3.2k, 4.0k, 5.0k [Hz])  
Adjusts the center frequency of Equalizer 2.
- 4 :EQ2 Gain (-12 to 0 to +12)  
Adjusts the gain of Equalizer 2.
- 5 :EQ3 Frequency (1.0k, 1.3k, 1.6k, 2.0k, 2.5k, 3.2k, 4.0k, 5.0k [Hz])  
Adjusts the center frequency of Equalizer 3.
- 6 :EQ3 Gain (-12 to 0 to +12)  
Adjusts the gain of Equalizer 3.
- 7 :Input Level (0 to 127)  
Adjusts the input level.
- 8 :Wet Level (0 to 127)  
Adjusts the level of the effect sound.
- 9 :Dry Level (0 to 127)  
Adjusts the level of the direct sound.

Note: The Gain value is not a dB value.

### 02: Compressor

Compresses the input signal, which can have the effect of suppressing level variation and can make it possible to sustain dampened sounds longer.

#### Parameter Value Ranges:

- 1 :Attack (0 to 127)  
Adjusts the attack amount of the input signal. A smaller value causes prompt compressor operation, which suppresses the attack of the input signal. A larger values delays compressor operation, which causes the attack of the input signal to be output as-is.
- 2 :Release (0 to 127)  
Adjusts the time from the point the input signal drops below a certain level until the compression operation is stopped. When an attack feeling is desired (no compression at the onset of sound), set this parameter to as low a value as possible. To have compression applied at all times, set a high value.
- 3 :Depth (0 to 127)  
Adjusts compression of the audio signal.
- 4 :Wet Level (0 to 127)  
Adjusts the level of the effect sound. Output volume changes in accordance with the Depth setting and the characteristics of the input tone.
- 5 :Dry Level (0 to 127)  
Adjusts the level of the direct sound.

### 03: Limiter

Limits the input signal level so it does not rise above a preset level.

#### Parameter Value Ranges:

- 1 :Limit (0 to 127)  
Adjusts the volume level of the limit at which limiting is applied.
- 2 :Attack (0 to 127)  
Adjusts the attack amount of the input signal.
- 3 :Release (0 to 127)  
Adjusts the time from the point the input signal drops below a certain level until the limit operation is stopped.
- 4 :Wet Level (0 to 127)  
Adjusts the level of the effect sound. Output volume changes in accordance with the Limit setting and the characteristics of the input tone. Use this parameter to correct for such changes.
- 5 :Dry Level (0 to 127)  
Adjusts the level of the direct sound.

### 04: Enhancer

Enhances the profiles of the low range and high range of the input signal.

#### Parameter Value Ranges:

- 1 :Low Frequency (0 to 127)  
Adjusts the low range enhancer frequency.
- 2 :Low Gain (0 to 127)  
Adjusts the low range enhancer gain.
- 3 :High Frequency (0 to 127)  
Adjusts the high range enhancer frequency.
- 4 :High Gain (0 to 127)  
Adjusts the high range enhancer gain.
- 5 :Input Level (0 to 127)  
Adjusts the input level.
- 6 :Wet Level (0 to 127)  
Adjusts the level of the effect sound.
- 7 :Dry Level (0 to 127)  
Adjusts the level of the direct sound.

### 05: Early Reflection

An effector that extracts early reflections from reverb. Applies acoustic presence to notes.

#### Parameter Value Ranges:

- 1 :Wet Level (0 to 127)  
Adjusts the level of the effect sound.
- 2 :Feedback (0 to 127)  
Adjusts the repeat of the reflected sound.
- 3 :Tone (0 to 127)  
Adjusts the tone of the reflected sound.
- 4 :Input Level (0 to 127)  
Adjusts the input level.
- 5 :Dry Level (0 to 127)  
Adjusts the level of the direct sound.

### 06: Phaser

Produces a distinctive pulsating, broad sound by using an LFO to change the phase of the input signal and then mixes it with the original input signal.

#### Parameter Value Ranges:

- 1 :Resonance (0 to 127)  
Adjusts the strength of feedback
- 2 :Manual (-64 to 0 to +63)  
Adjusts the reference phaser shift amount.
- 3 :LFO Rate (0 to 127)  
Adjusts the LFO rate.
- 4 :LFO Depth (0 to 127)  
Adjusts the LFO depth.
- 5 :LFO Waveform (Sin, Tri, Random)  
Selects the LFO waveform.
- 6 :Input Level (0 to 127)  
Adjusts the input level.
- 7 :Wet Level (0 to 127)  
Adjusts the level of the effect sound.
- 8 :Dry Level (0 to 127)  
Adjusts the level of the direct sound.

**07: Chorus**

Gives notes depth and breadth.

**Parameter Value Ranges:**

- 1 :LFO Rate (0 to 127)  
Adjusts the LFO rate.
- 2 :LFO Depth (0 to 127)  
Adjusts the LFO depth.
- 3 :LFO Waveform (Sin, Tri)  
Selects the LFO waveform.
- 4 :Feedback (-64 to 0 to +63)  
Adjusts the strength of feedback
- 5 :Wet Level (0 to 127)  
Adjusts the level of the effect sound.
- 6 :Polarity (-, +)  
Inverts the LFO of one channel.
- 7 :Input Level (0 to 127)  
Adjusts the input level.
- 8 :Dry Level (0 to 127)  
Adjusts the level of the direct sound.

**08: Flanger**

Applies wildly pulsating and metallic reverberation to notes. Selects the LFO waveform.

**Parameter Value Ranges:**

- 1 :LFO Rate (0 to 127)  
Adjusts the LFO rate.
- 2 :LFO Depth (0 to 127)  
Adjusts the LFO depth.
- 3 :LFO Waveform (Sin, Tri, Random)  
Selects the LFO waveform.
- 4 :Feedback (-64 to 0 to +63)  
Adjusts the strength of feedback
- 5 :Wet Level (0 to 127)  
Adjusts the level of the effect sound.
- 6 :Input Level (0 to 127)  
Adjusts the input level.
- 7 :Dry Level (0 to 127)  
Adjusts the level of the direct sound.

**09: Tremolo**

Shifts the volume of the input signal using an LFO.

**Parameter Value Ranges:**

- 1 :LFO Rate (0 to 127)  
Adjusts the LFO rate.
- 2 :LFO Depth (0 to 127)  
Adjusts the LFO depth.
- 3 :LFO Waveform (Sin, Tri, Tra)  
Selects the LFO waveform.
- 4 :Wet Level (0 to 127)  
Adjusts the level of the effect sound.
- 5 :Dry Level (0 to 127)  
Adjusts the level of the direct sound.

**10: Auto Pan**

Shifts the continual left-right panning of the input signal using an LFO.

**Parameter Value Ranges:**

- 1 :LFO Rate (0 to 127)  
Adjusts the LFO rate.
- 2 :LFO Depth (0 to 127)  
Adjusts the LFO depth.
- 3 :LFO Waveform (Sin, Tri, Tra)  
Selects the LFO waveform.
- 4 :Manual (-64 to 0 to +63)  
Adjusts the pan (stereo position). -64 is full left, 0 is center, and +63 is full right.
- 5 :Wet Level (0 to 127)  
Adjusts the level of the effect sound.
- 6 :Dry Level (0 to 127)  
Adjusts the level of the direct sound.

**11: Rotary**

This effect is a rotary speaker simulator.

**Parameter Value Ranges:**

- 1 :Speed (Slow, Fast)  
Switches the speed mode between fast and slow.
- 2 :Brake (Rotate, Stop)  
Stops speaker rotation.
- 3 :Fall Accel (0 to 127)  
Adjusts acceleration when the speed mode is switched from fast to slow.
- 4 :Rise Accel (0 to 127)  
Adjusts acceleration when the speed mode is switched from slow to fast.
- 5 :Slow Rate (0 to 127)  
Adjusts the speaker rotation speed in the slow speed mode.
- 6 :Fast Rate (0 to 127)  
Adjusts the speaker rotation speed in the fast speed mode.
- 7 :Vibrato/Chorus (Off, V1, C1, V2, C2, V3, C3)  
Selects the vibrato (V) and the chorus (C) type.
- 8 :Wet Level (0 to 127)  
Adjusts the level of the effect sound.
- 9 :Dry Level (0 to 127)  
Adjusts the level of the direct sound.

**12: Drive Rotary**

This is a rotary speaker simulator that makes overdrive possible.

**Parameter Value Ranges:**

- 1 :Overdrive Gain (0 to 127)  
Adjusts overdrive gain.
- 2 :Overdrive Level (0 to 127)  
Adjusts the overdrive output level.
- 3 :Speed (Slow, Fast)  
Switches the speed mode between fast and slow.
- 4 :Brake (Rotate, Stop)  
Stops speaker rotation.
- 5 :Fall Accel (0 to 127)  
Adjusts acceleration when the speed mode is switched from fast to slow.
- 6 :Rise Accel (0 to 127)  
Adjusts acceleration when the speed mode is switched from slow to fast.
- 7 :Slow Rate (0 to 127)  
Adjusts the speaker rotation speed in the slow speed mode.
- 8 :Fast Rate (0 to 127)  
Adjusts the speaker rotation speed in the fast speed mode.
- 9 :Vibrato/Chorus (Off, V1, C1, V2, C2, V3, C3)  
Selects the vibrato (V) and chorus (C) type.
- 10 :Wet Level (0 to 127)  
Adjusts the level of the effect sound.
- 11 :Dry Level (0 to 127)  
Adjusts the level of the direct sound.

### 13: LFO Wah

This is a “wah” effect that can automatically affect the frequency using an LFO.

**Parameter Value Ranges:**

- 1 :Input Level (0 to 127)  
Adjusts the input level. The input signal can become distorted when the level of the sound being input, the number of chords, or the Resonance value is large. Adjust this parameter to eliminate such distortion.
- 2 :Resonance (0 to 127)  
Adjusts the strength of feedback
- 3 :Manual (0 to 127)  
Adjusts the wah filter reference frequency.
- 4 :LFO Rate (0 to 127)  
Adjusts the LFO rate.
- 5 :LFO Depth (0 to 127)  
Adjusts the LFO depth.
- 6 :LFO Waveform (Sin, Tri, Random)  
Selects the LFO waveform.
- 7 :Wet Level (0 to 127)  
Adjusts the level of the effect sound.
- 8 :Dry Level (0 to 127)  
Adjusts the level of the direct sound.

### 14: Auto Wah

This is a “wah” effect that can automatically shift the frequency in accordance with the level of the input signal.

**Parameter Value Ranges:**

- 1 :Input Level (0 to 127)  
Adjusts the input level. The input signal can become distorted when the level of the sound being input, the number of chords, or the Resonance value is large. Adjust this parameter to eliminate such distortion.
- 2 :Resonance (0 to 127)  
Adjusts the strength of feedback
- 3 :Manual (0 to 127)  
Adjusts the wah filter reference frequency.
- 4 :Depth (-64 to 0 to +63)  
Adjusts the depth of the wah in accordance with the level of the input signal.  
Setting a positive value causes the wah filter to open in direct proportion with the size of the input signal, producing a bright sound. Setting a negative value causes the wah filter to close in direct proportion with the size of the input signal, producing a dark sound.
- 5 :Wet Level (0 to 127)  
Adjusts the level of the effect sound.
- 6 :Dry Level (0 to 127)  
Adjusts the level of the direct sound.

### 15: Distortion

Distortion + Wah + Amp Simulator

**Parameter Value Ranges:**

- 1 :Dist Gain (0 to 127)  
Adjusts the distortion input signal gain.
- 2 :Dist Level (0 to 127)  
Adjusts the distortion output level.
- 3 :Dist Low (0 to 127)  
Adjusts the distortion low-range gain.
- 4 :Dist High (0 to 127)  
Adjusts the distortion high-range gain.
- 5 :Wah Depth (-64 to 0 to +63)  
Adjusts the depth of the wah in accordance with the level of the input signal.
- 6 :Wah Manual (0 to 127)  
Adjusts the wah filter reference frequency.
- 7 :Routing (Dist, Wah, Wah-Dist, Dist-Wah)  
Specifies the distortion and wah connection.
- 8 :Amp (Bypass, TCombo, FCombo, ACombo, BCombo, JCombo, MStack, RStack, BassC, BassS)  
Specifies the amp simulation type.
- 9 :Wet Level (0 to 127)  
Adjusts the level of the effect sound.
- 10 :Dry Level (0 to 127)  
Adjusts the level of the direct sound.

### 16: Pitch Shifter

This effect transforms the pitch of the input signal.

**Parameter Value Ranges:**

- 1 :Pitch (-24 to 0 to +24)  
Adjusts the pitch shift amount in quarter tone steps.
- 2 :High Damp (0 to 127)  
Adjusts the high-range damp. A smaller number increases damping.
- 3 :Feedback (0 to 127)  
Adjusts the feedback amount.
- 4 :Input Level (0 to 127)  
Adjusts the input level.
- 5 :Wet Level (0 to 127)  
Adjusts the level of the effect sound.
- 6 :Dry Level (0 to 127)  
Adjusts the level of the direct sound.

### 17: Multi Chorus

This is a chorus effect with six different LFO phases.

**Parameter Value Ranges:**

- 1 :LFO Rate (0 to 127)  
Adjusts the LFO rate.
- 2 :LFO Depth (0 to 127)  
Adjusts the LFO depth.
- 3 :Wet Level (0 to 127)  
Adjusts the level of the effect sound.
- 4 :Dry Level (0 to 127)  
Adjusts the level of the direct sound.

### 18: Ring Modulator

Multiplies the input signal with an internal oscillator signal to create a metallic sound.

**Parameter Value Ranges:**

- 1 :OSC frequency (0 to 127)  
Sets the reference frequency of the internal oscillator.
- 2 :LFO Rate (0 to 127)  
Adjusts the LFO rate.
- 3 :LFO Depth (0 to 127)  
Adjusts the LFO depth.
- 4 :Tone (0 to 127)  
Adjusts the timbre of the ring modulator input sound.
- 5 :Wet Level (0 to 127)  
Adjusts the level of the effect sound.
- 6 :Dry Level (0 to 127)  
Adjusts the level of the direct sound.

**19: Delay**

Delays the input signal and feeds it back to create a repeating effect.

**Parameter Value Ranges:**

- 1 :Delay Time (0 to 127)  
Adjusts the total delay time.
- 2 :Delay Ratio L (0 to 127)  
Adjusts the ratio of the left channel relative to the total delay time.
- 3 :Delay Ratio R (0 to 127)  
Adjusts the ratio of the right channel relative to the total delay time.
- 4 :Delay Level L (0 to 127)  
Adjusts the level of the left channel.
- 5 :Delay Level R (0 to 127)  
Adjusts the level of the right channel.
- 6 :Feedback Type (Stereo, Cross)  
Selects the feedback type.  
Stereo: Stereo feedback  
Cross: Cross feedback
- 7 :Feedback (0 to 127)  
Adjusts the feedback amount.
- 8 :High Damp (0 to 127)  
Adjusts the high-range damp. A smaller number increases damping.
- 9 :Delay Tempo Sync (Off, 1/4, 1/3, 3/8, 1/2, 2/3, 3/4, 1)  
Specifies how the actual total delay time is synced with tempo.
  - Off: Uses Delay Time value.
  - 1/4 to 1: Uses value in accordance with number of beats.
- 10:Input Level (0 to 127)  
Adjusts the input level.
- 11 :Dry Level (0 to 127)  
Adjusts the level of the direct sound.
- 12 :Wet Level (0 to 127)  
Adjusts the level of the effect sound.

**20: Piano Effect**

This effect is suited to acoustic piano play.

**Parameter Value Ranges:**

- 1 :Lid Type (Closed, Semi Opened, Full Opened)  
Adjusts how sound resonates in accordance with the opening state of a piano lid.
- 2 :Reflection Level (0 to 127)  
Adjusts the level of the initial reflection.
- 3 :Input Level (0 to 127)  
Adjusts the input level.
- 4 :Wet Level (0 to 127)  
Adjusts the level of the effect sound.
- 5 :Dry Level (0 to 127)  
Adjusts the level of the direct sound.

# Using Auto Accompaniment

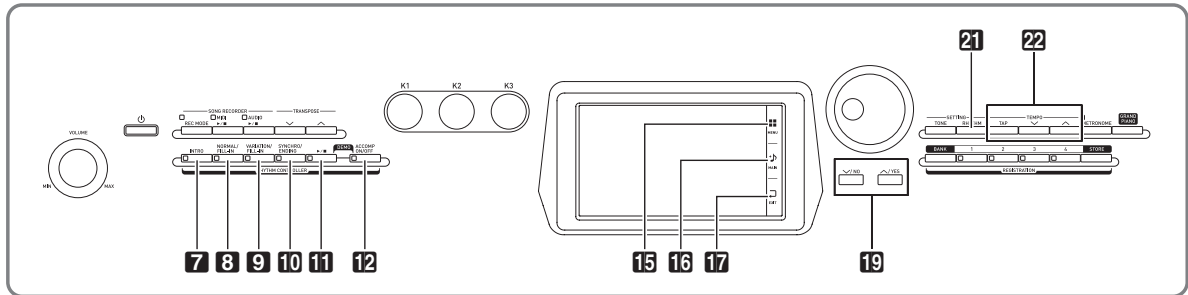

With Auto Accompaniment, simply select the accompaniment rhythm you want and the matching accompaniment (drums, guitar, etc.) will play automatically when you play a chord with your left hand. It's like having your own personal backup group along with you wherever you go.

This Digital Piano has 220 built-in Auto Accompaniment patterns, which are divided into 13 groups. You can edit built-in rhythms to create your own original rhythms (called "user rhythms"), which you can save in a 14th group. Refer to the separate Appendix for details.

## Playing an Auto Accompaniment

1. On the screen, touch **16** MAIN. This displays the MAIN screen.

2. Touch the "Rhythm" rhythm name.

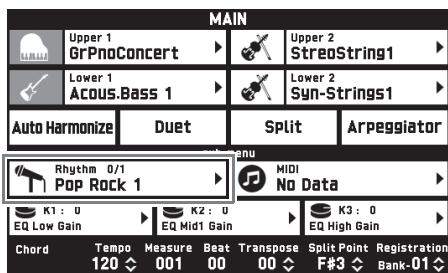

3. Touch the group that contains the rhythm you want to use.

- You can navigate between groups by touching "◀◀" or "▶▶".

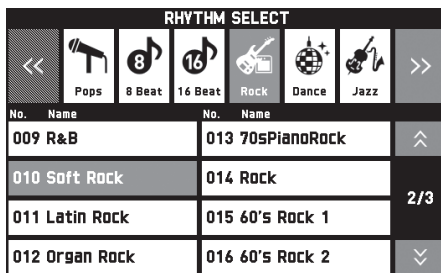

4. Touch the rhythm you want to use.

- You can navigate between rhythm list pages by touching "▲" or "▼".

5. Use the **22** TEMPO  $\nabla$ ,  $\blacktriangle$  buttons to adjust the tempo setting.

- For information about the tempo adjustment method, see "Changing the Tempo Setting" (page EN-20).
- To return a rhythm to its recommended tempo setting, press the **22** TEMPO  $\nabla$ ,  $\blacktriangle$  buttons at the same time.

## 6. Press the **12** ACCOMP ON/OFF button so its lamp is lit.

This turns ACCOMP on, so all accompaniment parts sound.

- Turning ACCOMP off so the ACCOMP lamp is unlit causes only the percussion instrument parts (Drums, Percussion) to sound.
- Each press of the button toggles ACCOMP between on and off.

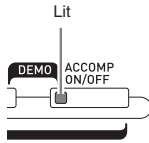

## 7. Press the **10** SYNCHRO/ENDING button.

This puts Auto Accompaniment into "synchro standby". Playing a chord during synchro standby will cause Auto Accompaniment to start to play automatically.

- Pressing the **7** INTRO button while Auto Accompaniment is in synchro standby will enter intro standby. Pressing the **9** VARIATION button will enter variation standby. For details about intro and variation patterns, see "Modifying Auto Accompaniment Patterns" (page EN-41).

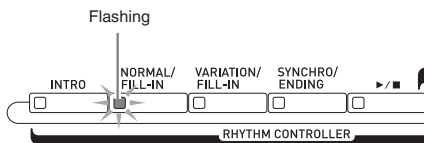

## 8. Play the chord you want on the chord keyboard (left keyboard keys).

Auto Accompaniment will start playing when you play the chord.

- To start percussion part play without playing a chord, press the **11** ►/■ button.

*Example:* To play a C chord

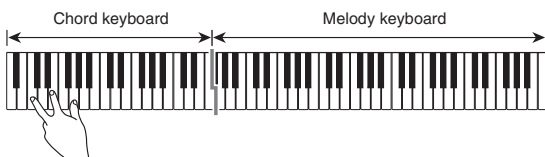

## 9. Play other chords with your left hand as you play the melody with your right hand.

- You can use "CASIO Chord" or other simplified chord fingering modes to play chords. For details, see "To select a chord fingering mode" in the following section.
- You can use the **8** NORMAL and **9** VARIATION buttons to modify accompaniment patterns. For details, see "Modifying Auto Accompaniment Patterns" (page EN-41).

## 10. When you are finished, press the **11** ►/■ button again to stop Auto Accompaniment.

- Pressing the **10** SYNCHRO/ENDING button instead of the **11** ►/■ button will play an ending pattern before stopping Auto Accompaniment play. For details about ending patterns, see "Modifying Auto Accompaniment Patterns" (page EN-41).

### NOTE

- You can adjust the volume level of the Auto Accompaniment, without affecting the volume of Digital Piano output. For details, see "BALANCE Screen" (page EN-70).
- You can change the size of the chord keyboard by using the split feature to move the split point (page EN-16). The keyboard keys to the left of the split point make up the chord keyboard.



## To select a chord fingering mode

You can select from among the following five chord fingering modes.

Fingered 1  
Fingered 2  
Fingered 3  
CASIO Chord  
Full Range

1. On the MENU screen, touch "RHYTHM".
2. Touch "Chord Input Type".
3. Touch the chord input method you want to use.  
This changes to the selected chord input method.

### ■ Fingered 1, 2, 3

With these three chord fingering modes, you play chords on the chord keyboard using their normal chord fingerings. Some chord forms are abbreviated, and can be fingered with one or two keys. For information about the types of chords you can finger and their fingerings, see the "Fingering Guide" (page A-1).



- Fingered 1: Play the component notes of the chord on the keyboard.
- Fingered 2: Unlike Fingered 1, 6th input is not possible with this mode.
- Fingered 3: Unlike Fingered 1, this mode allows input of fraction chords with the lowest keyboard note as the bass note.

### ■ CASIO CHORD

With "CASIO Chord", you can use simplified fingerings to play the four types of chords described below.



Chord Type	Example
<b>Major Chords</b> Press one key, whose note corresponds to the chord name. <ul style="list-style-type: none"> <li>To play C Major, press any C key in the chord keyboard. The octave of the note does not matter.</li> </ul>	C (C Major) Note name J
<b>Minor Chords</b> Press the chord keyboard key that corresponds to the major chord, while also pressing one other chord keyboard key to the right.	Cm (C minor) 
<b>Seventh Chords</b> Press the chord keyboard key that corresponds to the major chord, while also pressing two other chord keyboard keys to the right.	C7 (C seventh) 
<b>Minor Seventh Chords</b> Press the chord keyboard key that corresponds to the major chord, while also pressing three other chord keyboard keys to the right.	Cm7 (C minor seventh) 

When pressing more than one chord keyboard key, makes no difference whether the additional keys are white or black.

### ■ FULL RANGE CHORD

With this chord fingering mode, you can use the full range of the keyboard to play chords and the melody. For information about the types of chords you can finger and their fingerings, see the "Fingering Guide" (page A-1).



## Modifying Auto Accompaniment Patterns

There are six different Auto Accompaniment patterns, shown below. You can switch between patterns during accompaniment play and even modify patterns. Use buttons **7** through **10** to select the pattern you want.

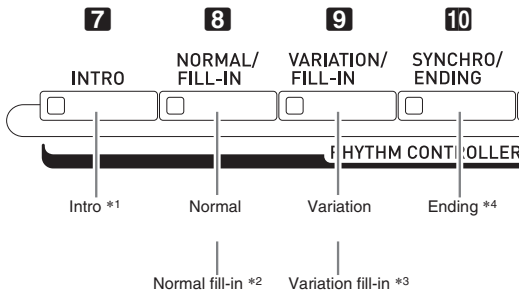

- \*1 Press at the beginning of a song.  
Accompaniment play proceeds with the normal pattern after the intro pattern is complete. Pressing the **9** **VARIATION/FILL-IN** button before the intro pattern is finished will proceed with the variation pattern after the intro pattern is complete.
- \*2 Press while a normal pattern is playing to insert a fill-in pattern.
- \*3 Press while a variation pattern is playing to insert a fill-in variation pattern.
- \*4 Press at the end of a song.  
This will play an ending pattern and then stop Auto Accompaniment.

## Using Recommended Tones and Tempos (One-Touch Presets)

One-Touch Preset gives you one-touch access to tone and tempo settings that go well with the currently selected Auto Accompaniment rhythm pattern.

### 1. On the MENU screen, touch "RHYTHM".

This displays the RHYTHM screen.

- You can also display the RHYTHM screen by pressing the **21** **RHYTHM** button.

### 2. Touch "One Touch".

This configures tone, tempo, and other settings to match the currently selected rhythm pattern.

At this time, Auto Accompaniment play also will go into synchro standby, which means that Auto Accompaniment will start to play automatically when you finger a chord.

### 3. Play a chord on the keyboard.

This will start Auto Accompaniment play.

#### **NOTE**

- One-Touch Presets are not supported for user rhythms (001 through 030 of the user group).

## Adding Harmony to Melody Notes (Auto Harmonize)

Auto Harmonize lets you add harmony to melody notes you play with your right hand for more melodic depth. You can select any one of 12 Auto Harmonize types.

1. On the screen, touch **16 MAIN**.

This displays the MAIN screen.

2. Touch “Auto Harmonize” to turn it on.

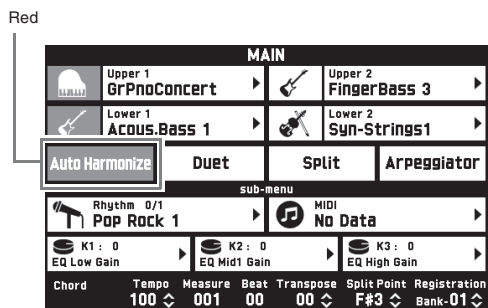

3. Touch **15 MENU**.

4. On the MENU screen, touch “RHYTHM”.

5. Touch “Auto Harmonize Type”.

6. Touch the Auto Harmonize type you want to use.

Type Name	Description
Duet 1	Adds close (separated by two to four degrees) 1-note harmony below the melody note.
Duet 2	Adds open (separated by more than 4 to 6 degrees) 1-note harmony below the melody note.
Country	Adds country style harmony.
Octave	Adds the note from the next lower octave.
5th	Adds the fifth degree note.
3-Way Open	Adds 2-note open harmony, for a total of three notes.
3-Way Close	Adds 2-note close harmony, for a total of three notes.
Strings	Adds harmony that is optimal for strings.
4-Way Open	Adds 3-note open harmony, for a total of four notes.
4-Way Close	Adds 3-note close harmony, for a total of four notes.
Block	Adds block chord notes.
Big Band	Adds big band style harmony.

7. Play chords and the melody on the keyboard.

Harmony will be added to your melody notes based on the chords you play.

## Creating Your Own Original Rhythm by Editing a Built-in Auto Accompaniment (Rhythm Edit)

You can use the rhythm editor to modify a built-in Auto Accompaniment and create an original “user rhythm” of your own.

You can select a part (Drums, Bass, etc.) of a normal, intro, or other pattern (page EN-41) and turn it on or off, adjust its volume level, and perform other operations.

1. Perform steps 1 through 4 under “Playing an Auto Accompaniment” (page EN-38) to select the rhythm you want to edit.

2. On the MENU screen, touch “RHYTHM”.

3. Touch “Edit”.

4. Touch “Edit”.

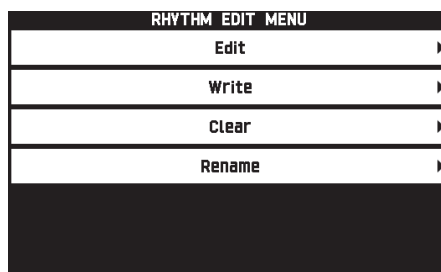

5. Use buttons **7** through **10** to select the accompaniment pattern you want to edit.

The button you press will light, indicating that the pattern is being edited.

- Each press of the **8** toggles between NORMAL and FILL-IN, and each press of **9** toggles between VARIATION and FILL-IN. The applicable button flashes while the fill-in pattern is selected.

*Example:* When intro is selected

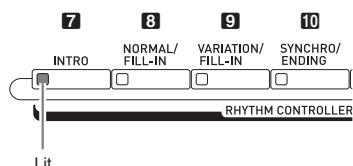

## 6. Touch the display item for the instrument part you want to edit.

Rhythm, tone: Touch the display item and then select from the list that appears.

To change the settings of items other than those above, use the **19**  $\vee$ ,  $\wedge$  buttons to change the displayed value.

- Rhythm patterns are made up of the eight parts below.  
Drums, Percussion, Bass, Chord 1, Chord 2, Chord 3, Chord 4, Chord 5
- Pressing the **11**  $\blacktriangleright/\blacksquare$  button during an editing operation will sound the accompaniment pattern with the edits you have made up to that point. Touching “Solo” will sound only the instrument part you are editing.
- The table below describes the parameters you can edit.

Item	Description	Setting
Rhythm (Rhythm)	Replaces the part accompaniment data with that of the specified rhythm number. *1	Rhythm number *2
Part	Toggles each part on or off.	White: Part is muted. Red: Part sounds.
Tone (Tone)	Changes the tone (instrument) for part play.	Tone name *3
Volume (Volume)	Controls the volume level of each part.	000 to 127
Pan (Pan)	Controls whether the sound of the part can be heard from the left side or right side.	-64 to 0 to 63 *4
Reverb Send (Reverb Send)	Specifies how much reverb (page EN-71) is applied to each part.	000 to 127
Chorus Send (Chorus Send)	Specifies how much chorus (page EN-71) is applied to each part.	000 to 127
Delay Send (Delay Send)	Specifies how much delay (page EN-71) is applied to each part.	000 to 127

- \*1 Replacing part accompaniment data clears all edits made up to that point.
- \*2 For an intro, the same rhythm number is applied to all of the eight instrument parts. For example, if you assign rhythm 003 to Chord 1, rhythm 003 is automatically assigned to the other seven instrument parts as well. If you later change Chord 2 to rhythm 004, the Chord 1 rhythm also changes to 004.  
Like the intro, all of the eight parts of an ending also are the same rhythm number.
- \*3 Only drum set tones can be selected for Drums and Percussion parts.  
Drum set sounds cannot be selected for the Bass and the Chord 1 through Chord 5 parts.
- \*4 A smaller value shifts the pan position to the left while a larger value shifts to the right. A value of zero specifies center.

## 7. After editing is complete, adjust the tempo of the rhythm as desired.

- The tempo you set here becomes the initial default tempo.

## 8. On the screen, touch **17** EXIT.

## 9. Touch “Write”.

This displays a screen for specifying the destination user rhythm number and rhythm name.

- If you want to exit the editing operation without saving, touch **17** EXIT.

## 10. Touch “Rename”.

## 11. Input a name for the rhythm.

## 12. After inputting the rhythm name, touch “Enter”.

## 13. Touch the destination user rhythm number.

- If the rhythm number already has data assigned to it, there will be an asterisk (\*) next to it.

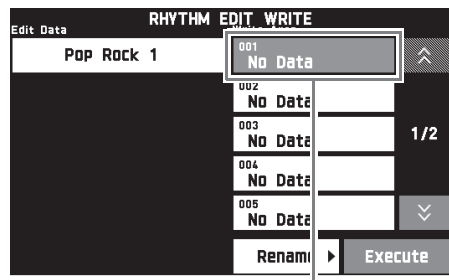

Destination user rhythm number

## 14. Touch “Execute”.

If the selected rhythm number does not have any data assigned to it, the message “Sure?” will appear. If it does have data assigned to it, the message “Replace?” will appear.

## 15. Touch “Yes”.

This stores the data.

- To return to the screen in step 4 without saving, touch “No”.

### IMPORTANT!

- Saving user rhythm data to a user rhythm number that already has data will cause the existing data to be replaced by the new data.

### NOTE

- If the size of the accompaniment pattern or instrument part data is too large to be edited, a memory full message (Memory Full) will appear on the display. If that happens, select a different accompaniment pattern or instrument part for editing.

## Deleting a User Rhythm

1. On the MENU screen, touch “RHYTHM”.

2. Touch “Edit”.

3. Touch “Clear”.

4. Touch the user rhythm you want to delete and then touch “Execute”.

5. Touch “Yes”.

This deletes the selected user rhythm.

- To cancel the delete operation, touch “No”.

# Demo Song

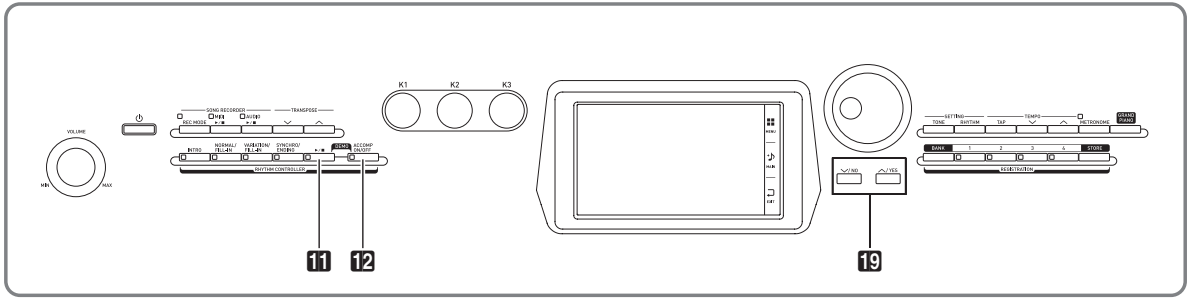

## Playing the Demo Tunes

1. While holding down the **12 ACCOMP ON/OFF** button, press the **11 ►/■** button.

This will start sequential playback of the demo songs, starting from song 1.

- You can use the **19**  $\nabla$ ,  $\wedge$  buttons to change to another demo song.

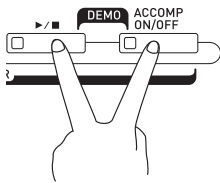

2. Press the **11 ►/■** button.

This stops demo song playback.

Playback of the demo songs will continue in an endless loop until you press the **11 ►/■** button to stop it.

### NOTE

- Only the operations described above can be performed while demo song playback is in progress.

# Music Presets

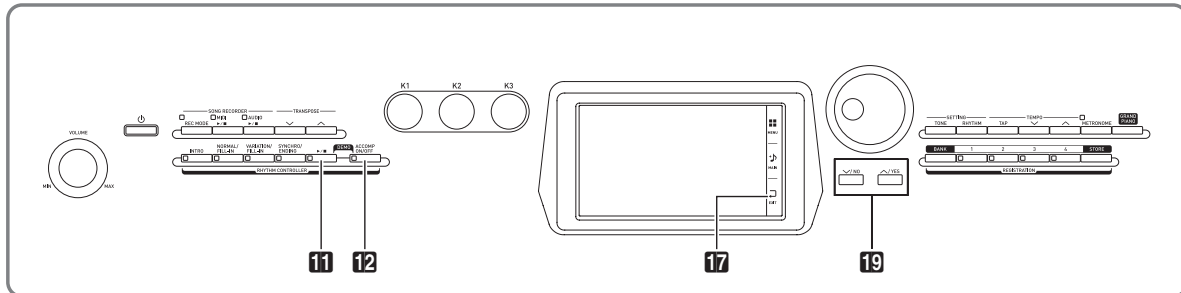

Music Presets provide you with one-touch tone, rhythm, chord, and other settings that are optimized for specific musical genres and songs. In addition to built-in presets, you can create your own original Music Presets (user presets).

There is a total of 305 built-in music presets, which are divided into nine groups. A tenth group is provided for user presets.

- Refer to the separate Appendix for details.

## Recalling Preset Data

1. On the MENU screen, touch “MUSIC PRESET”.

This displays the MUSIC PRESET screen and turns on Auto Chord.

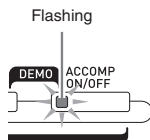

2. Touch the preset name.

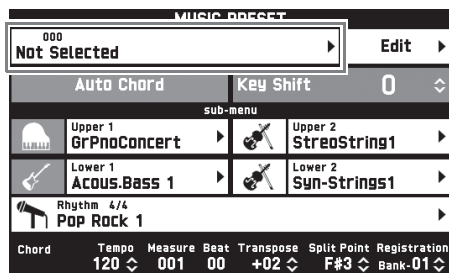

3. Touch the group that contains the preset you want to use and then touch the preset name.

This configures the Digital Piano with the settings (tone, rhythm, etc.) of the selected preset.

4. Press the **11** ►/■ button to start Auto Accompaniment with the preset chord progression. Play the melody on the keyboard.

- The preset chord progression repeats until you stop it by pressing the **11** ►/■ button again.
- Touching “Auto Chord” to turn it off turns off the preset chord progression, which enables play of the normal Auto Accompaniment pattern.
- To change the key of a preset chord progression, touch “Key Shift” and then use the **19** ▼, ▲ buttons to make the change.

### NOTE

- To turn off Auto Chord, press the **12** ACCOMP ON/OFF button.
- For details about the settings for a recalled preset, see the separate Appendix.

## Creating an Original User Preset (User Presets)

A music preset editor is provided to allow you to create your own original music presets (user presets). Up to 100 user presets can be stored in the user group.

1. Perform step 1 through 3 in the procedure under “Recalling Preset Data” (page EN-46) to select the preset you want to use as the basis for your user preset.

2. Touch “Edit”.

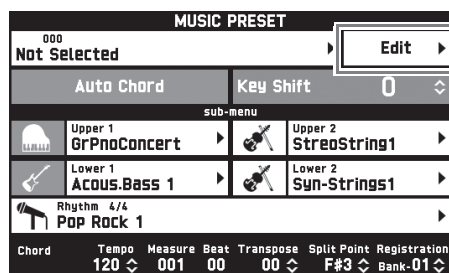

3. Edit the music preset parameters.

### 3-1. To edit the chord progression

Touch “Chord Edit” to display the chord progression editing screen.

Next, perform the editing operation described under “To edit a chord progression” (page EN-47). After you are finished, touch **EXIT** to return to the screen above.

### 3-2. To change how an Auto Accompaniment is played

Touch “Parameter Edit” to display the parameter editing screen.

Next, perform the editing operation described under “To change how an Auto Accompaniment is played” (page EN-49). After you are finished, touch **EXIT** to return to the screen above.

4. After editing everything you want, touch “Write”.

5. Touch “Rename”.

6. Input a name for the preset.

7. After inputting the preset name, touch “Enter”.

8. Touch the destination preset number.

- If the preset number already has data assigned to it, there will be an asterisk (\*) next to it.

9. Touch “Execute”.

If the selected preset number does not have any data assigned to it, the message “Sure?” will appear. If it does have data assigned to it, the message “Replace?” will appear.

10. Touch “Yes”.

This stores the data.

- To return to the screen in step 8 without saving, touch “No”.

## To edit a chord progression

1. On the editing operation selection screen (page EN-47), touch “Chord Edit” to display the chord progression editing screen shown below.

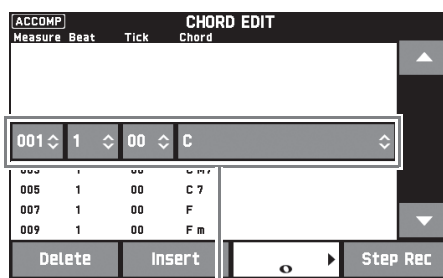

Step (timing and chord)

### Step (timing and chord)

The timing of a chord progression is expressed as a series of three values (such as 001:1:00) indicating measure\*1 (001), beat (1), and tick (00)\*2. This series of three values is referred to collectively as a “step”.

\*1 Up to 999 measures

\*2 There are 12 ticks per beat, as shown below.

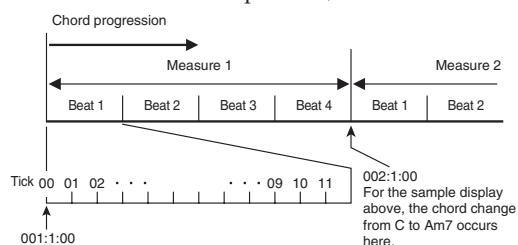

2. Edit the step as desired.

- You can playback and check the edited progression by pressing the **STOP** button. Chord progression editing cannot be performed while chord progression playback is in progress.



- After you are finished, touch **EXIT** to return to the editing type selection screen (page EN-47).

**NOTE**

- Up to approximately 999 measures can be contained in a single preset. If your edits cause this limit to be exceeded, the message “Measure Limit” will appear on the screen and further editing will become impossible.

**To edit preset chord information**

- Use the on-screen “▲” and “▼” icons to select the step you want to change.
- Input timing information or a chord.
  - To change the timing, touch the current “Measure”, “Beat”, or “Tick” value, and then use the **19** **▼**, **▲** buttons to change the timing value.
  - To change a chord, touch it and then play the desired chord on the keyboard.

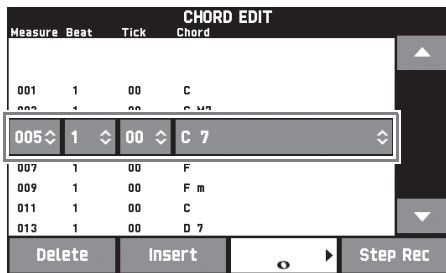

- The timing of the first step (001:1:00) is fixed and cannot be changed. Also, the final step is always one measure, regardless of the resolution.

**To insert a new chord**

- Use the on-screen “▲” and “▼” icons to select the step that comes immediately before the location where you want to insert a new chord.
- Touch “Insert” and then play the desired chord on the keyboard.

**To insert a sequential series of steps**

- Use the on-screen “▲” and “▼” icons to select the step that comes immediately before the location where you want to insert the step.
- Touch “Step Rec”.
- Touch the note icon.

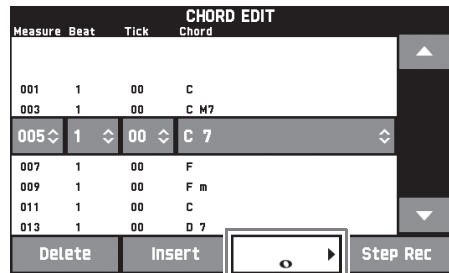

- Touch the note you want to use.
- Play a chord on the keyboard. This inputs a step of the length you specified in step 4 above, and then advances to input of the next step.
  - Touching “Tie” without inputting a chord will specify a tie.
  - Touching “Rest” without inputting a chord will result in no chord being played during that step.
- After you are finished inserting steps, touch “Step Rec” again to exit data editing.

**To delete a step**

- Use the on-screen “▲” and “▼” icons to select the step you want to delete.
- Touch “Delete”.
  - You cannot delete the first step or the last step.

## To change how an Auto Accompaniment is played

1. On the editing type selection screen (page EN-47), touch “Parameter Edit” to display the auto accompaniment play editing screen shown below.

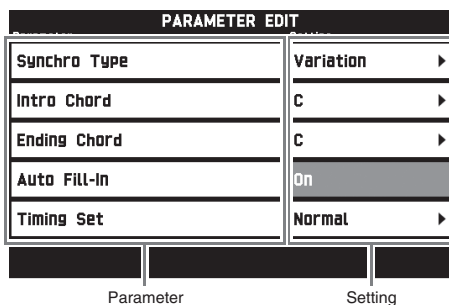

2. Touch the parameter whose setting you want to change, and then use the **19**  $\vee$ ,  $\wedge$  buttons to change the setting value.

Parameter	Description	Setting
Synchro Type: Synchro type	Selects the synchro standby status and type when the music preset is selected.	Off (no standby) Normal: From standby to normal pattern Variation: From standby to variation pattern Intro: From standby to intro pattern
Intro Chord: Intro chord	Selects from among major (12 keys) and minor (12 keys) for the intro chords.	C to B: Major (C to B) Cm to Bm: Minor (Cm to Bm)
Ending Chord: Ending chord	Selects from among major (12 keys) and minor (12 keys) for the ending chords.	C to B: Major (C to B) Cm to Bm: Minor (Cm to Bm)
Auto Fill-In: Auto fill-in on/off	Specifies whether or not a fill-in should be inserted into the final measure of a chord progression.	Off: Fill-in not inserted On: Fill-in inserted
Timing Set: Chord progression variation	This parameter lets you add different variations to the timing of the chord progression being edited. You can use it to match the chord progression to the beat of a specific rhythm. For information about differences in playback for each setting value, see “Timing Setting and Chord Progression Playback” (page EN-50).	Normal, Half, Double, 3/4, 3/2

3. After you are finished, touch **17** EXIT to return to the editing type selection screen (page EN-47).

## ■ Timing Setting and Chord Progression Playback

This section explains how chord progressions are played in accordance with the “Timing Set” settings in step 2 under “To change how an Auto Accompaniment is played” (page EN-49). Note that this setting affects playback only. It does not change the chord progression data.

- Normal

Plays chords at the same timing as the recording.

- Half

Plays chords measure-by-measure at a timing that is half that of the recording.

Example:

Measure	1	2	3	4
Beat	1 2 3 4	1 2 3 4	1 2 3 4	1 2 3 4
Chord progression	Dm A7	Dm G7	C Em	Am C7

The following shows what happens when the “Half” setting is used to play back a user preset that was created based on a music preset whose rhythm is a 4/4 time.

### Half Playback when a 4/4 time rhythm is assigned to the user preset

Measure	1	2	3	4
Beat	1 2 3 4	1 2 3 4	1 2 3 4	1 2 3 4
Chord progression	Dm A7	Dm G7	C Em	Am C7

### Half Playback when a 2/4 time rhythm is assigned to the user preset

Measure	1	2	3	4
Beat	1 2	1 2	1 2	1 2
Chord progression	Dm A7	Dm G7	C Em	Am C7

- Double

Plays chords measure-by-measure at a timing that is double that of the recording.

Playing back a chord progression like that shown for “Half” above while “Double” is specified results in the progression shown below.

### Double Playback when a 4/4 time rhythm is assigned to the user preset

Measure	1	2	3	4
Beat	1 2 3 4	1 2 3 4	1 2 3 4	1 2 3 4
Chord progression	Dm	Dm	C	Am

### Double Playback when an 8/4 time rhythm is assigned to the user preset

Measure	1	2	3
Beat	1 2 3 4 5 6 7 8	1 2 3 4 5 6 7 8	1 2
Chord progression	Dm A7	Dm G7	C

## ● 3/4

Plays chords measure-by-measure at a timing that is 3/4 times that of the recording. This setting is best for use with a 6/8 time rhythm.

Playing back a chord progression like that shown for “Half” above while “3/4” is specified results in the progression shown below.

**3/4 Playback when a 4/4 time rhythm is assigned to the user preset**

Measure	1	2	3	4
Beat	1 2 3 4	1 2 3 4	1 2 3 4	1 2 3 4
Chord progression	Dm A7	Dm G7	C Em	Am C7

**3/4 Playback when a 6/8 time rhythm is assigned to the user preset**

Measure	1	2	3	4
Beat	1 2 3 4 5 6	1 2 3 4 5 6	1 2 3 4 5 6	1 2
Chord progression	Dm A7	Dm G7	C Em	Am

## ● 3/2

Plays chords measure-by-measure at a timing that is 3/2 times that of the recording. This setting is best for use with a 6/4 time rhythm.

Playing back a chord progression like that shown for “Half” above while “3/2” is specified results in the progression shown below.

**3/2 Playback when a 4/4 time rhythm is assigned to the user preset**

Measure	1	2	3	4
Beat	1 2 3 4	1 2 3 4	1 2 3 4	1 2 3 4
Chord progression	Dm A7	Dm G7	C Em	Am C7

**3/2 Playback when a 6/4 time rhythm is assigned to the user preset**

Measure	1	2	3	4
Beat	1 2 3 4 5 6	1 2 3 4 5 6	1 2 3 4 5 6	1 2
Chord progression	Dm A7	Dm G7	C Em	Am

 **NOTE**

- When “Double” or “3/2” is selected, chord timing is shifted to a later timing. Any chords that do not fit within a measure are not played.

## Deleting a User Preset

1. On the MENU screen, touch “MUSIC PRESET”.
2. Touch “Edit”.
3. Touch “Clear”.
4. Touch the user preset you want to delete and then touch “Execute”.
5. Touch “Yes”.

This deletes the selected user preset.

- To cancel the delete operation, touch “No”.

# Registering Tone and Rhythm Setups

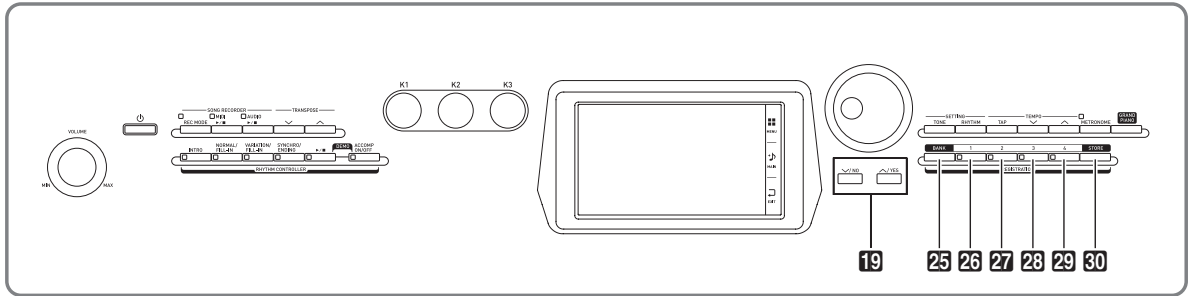

Registration memory lets you store Digital Piano setups (tone, rhythm, etc.) for instant recall whenever you need them. Registration memory simplifies performance of complex pieces that require successive tone and rhythm changes.

You can have up to 96 setups in Registration memory at one time. To select a setup, use the **25** BANK button and **REGISTRATION** buttons **26** through **29**.

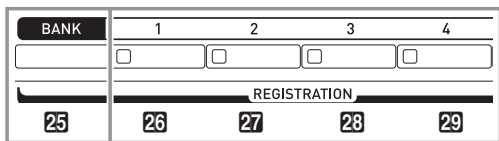

	Area 1	Area 2	Area 3	Area 4
Bank 1	Setup 1-1	Setup 1-2	Setup 1-3	Setup 1-4
Bank 2	Setup 2-1	Setup 2-2	Setup 2-3	Setup 2-4
.	.	.	.	.
Bank 24	Setup 24-1	Setup 24-2	Setup 24-3	Setup 24-4

- Press the **25** BANK button and then use the **19**  $\nabla$ ,  $\wedge$  buttons to change the bank number.
- Pressing a **REGISTRATION** button (**26** through **29**) selects the corresponding area in the currently selected bank.

## NOTE

- Refer to the separate Appendix for details.

## To save registration data

1. Configure the Digital Piano with the tone, rhythm, and other settings you want to save.
2. While holding down the **30** STORE button, perform the operation below.

Use the **19**  $\nabla$ ,  $\wedge$  buttons to select the bank where you want to store the data, and then press a **REGISTRATION** button (**26** through **29**) to specify an area.

The data will be saved to the bank and area you specify.

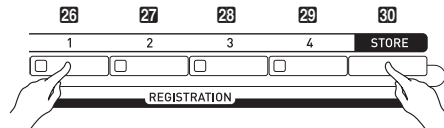

Example: Bank 4, Area 1

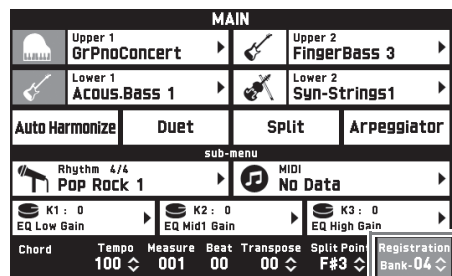

Bank

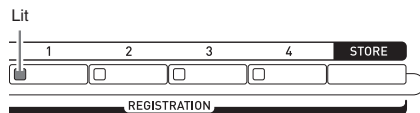

## To recall a registration setup

- Press the **25** **BANK** button to select the bank that contains the setup you want to recall.
  - The currently selected bank and area numbers are shown on the MAIN screen and button lamps.

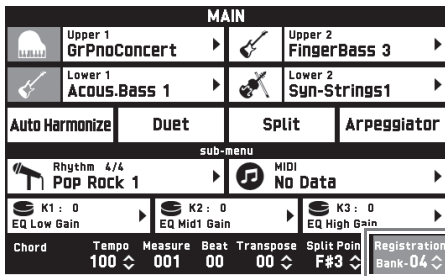
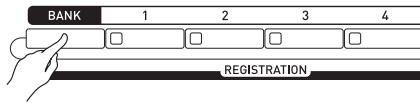

- Use the **REGISTRATION** buttons (**26** through **29**) to select the area whose setup you want to recall.

This recalls the registration memory setup and automatically configure the Digital Piano settings accordingly.

*Example:* When recalling the registration data in Bank 4, Area 1

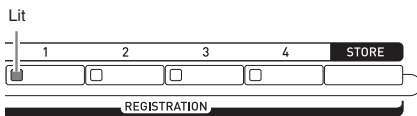

### NOTE

- You can specify which particular items should remain unchanged when a registration function setup is applied. For details, see “REGISTRATION Screen” under “Configuring Digital Piano Settings” (pages EN-68 through EN-81).

### ■ Saving Setup Registration Data to an External Device

See “Connecting to a Computer” (page EN-86).

# Recording and Playback

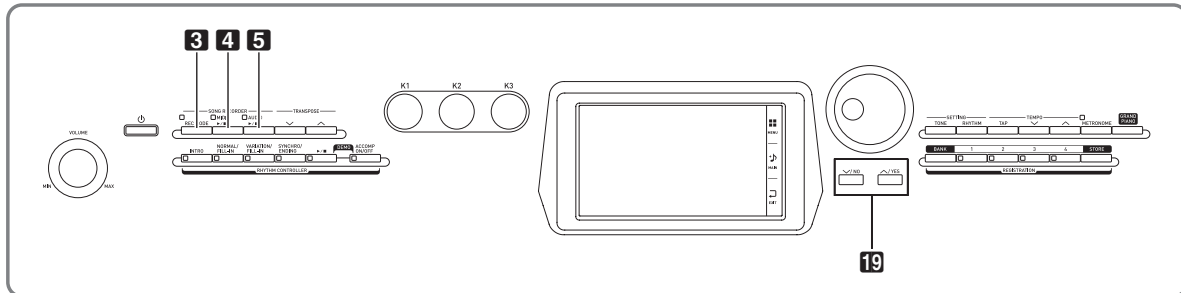



Your Digital Piano can record what you play on the keyboard and play it back when you want. The Digital Piano has two recording functions: a MIDI Recorder and an Audio Recorder. Select the function that suits the needs for the type of recording you want to make.

## IMPORTANT!

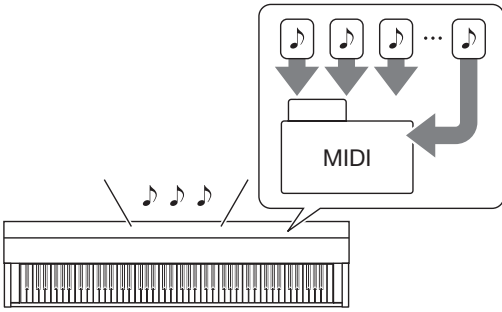
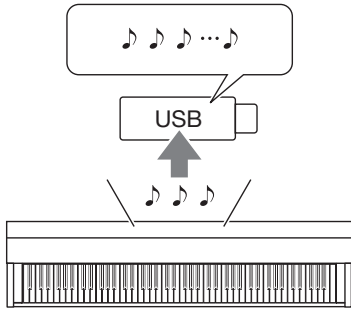

- CASIO COMPUTER CO., LTD. takes no responsibility for any damages, lost profits, or claims by third parties arising from the deletion of recorded data due to malfunction, repair, or for any other reason.

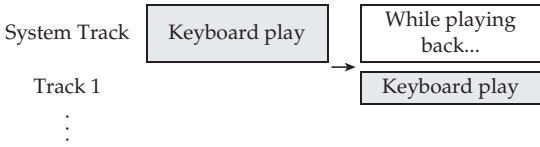
## Recording Features

MIDI Recorder	Audio Recorder
<p>Keyboard performance information is recorded as MIDI data* to a system track or 16 tracks (storage areas for keyboard performance data) in Digital Piano memory.</p>  <ul style="list-style-type: none"> <li>• Keyboard performance information (keyboard keys press/release, touch pressure, etc.) is recorded as MIDI data.</li> <li>• The size of MIDI data is much smaller when compared with audio data, making it easier to edit later on a computer, etc.</li> <li>• Supported recording capacity: 100 songs approximately 50,000 notes per song (total of all tracks)</li> </ul>	<p>Keyboard performance information is recorded to a USB flash drive as audio data.</p>  <ul style="list-style-type: none"> <li>• Like a portable music player or tape recorder, notes are recorded as audio data.</li> <li>• Audio data files are much larger compared to MIDI data files. The advantage of audio data files is that they can be easily played back on a computer, portable music player, etc.</li> <li>• Supported recording capacity: Up to 100 files, each file up to a maximum length of 74 minutes</li> </ul>

MIDI Recorder	Audio Recorder
<p><b>What you can do...</b> Record to one track while playing back from the other track</p> 	<p><b>What you can do...</b> Record performance while playing back a song recorded with the MIDI Recorder</p>  <p>Record input of an external device connected to the LINE IN terminal along with Digital Piano performance and playback</p> <p><b>NOTE</b></p> <ul style="list-style-type: none"> <li>AUDIO IN terminal input is not recorded.</li> </ul>

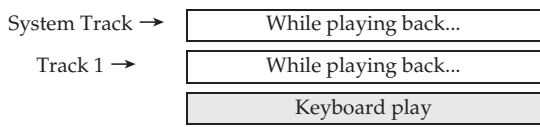
## ■ Playback Features

MIDI Recorder	Audio Recorder
<p>Playback plays the system track and tracks 1 through 16.</p> <ul style="list-style-type: none"> <li>With the MIDI Recorder, the Digital Piano automatically performs playback using its internal sound source in accordance with the performance information recorded as MIDI data.</li> </ul> <p><b>What you can do...</b> Play on the keyboard along with playback of tracks</p> 	<p>You can play back audio data from a USB flash drive.</p> <ul style="list-style-type: none"> <li>The Audio Recorder plays back the waveform of sound recorded as audio data.</li> </ul> <p><b>What you can do...</b> You can play along on the keyboard while the audio data is playing.</p> 

### \* MIDI

MIDI is short for “Musical Instrument Digital Interface”. It is a universal standard that makes it possible for musical instruments, computers, and other devices to exchange performance information (keyboard key press/release, touch pressure, etc.) regardless of manufacturer. Performance data in this case is called “MIDI data”.



## Recording to Digital Piano Memory (MIDI Recorder)

Perform the steps below to record your keyboard play to Digital Piano Memory.

### 1. Configure the tone, rhythm, and other settings you want to use.

- The settings you configure here will be included as part of the recorded MIDI data.
- For details about what is included in the recorded MIDI data, see “System Track” (page EN-57).

### 2. On the MENU screen, touch “MIDI RECORDER”.

### 3. Touch “●”.

This turns on the recorder and enters record mode.

- Each touch of “●” cycles through modes as shown below.

Playback mode

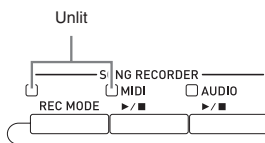
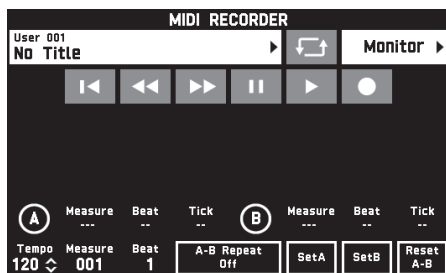

Recording mode

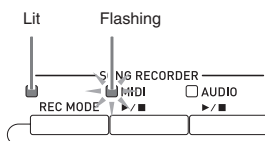
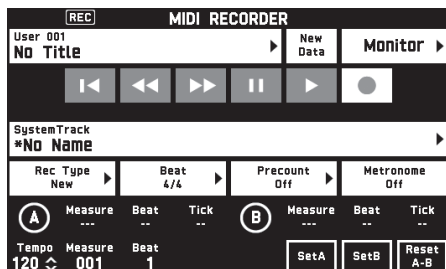

### 4. Touch “New Data”.

This enables recording of new data to the system track.

### 5. Play something on the keyboard.

Recording starts as soon as you play something.

- You can also start recording by touching “▶”.
- You also can configure the piano so Auto Accompaniment is included in the recorded data.
- The **4** MIDI ▶/■ button is lit while recording is in progress.

### 6. After you finish recording, touch “■”.

This causes the **3** REC MODE button and **4** MIDI ▶/■ button lamps to become unlit, and enters the playback mode.

Unlit: Playback mode

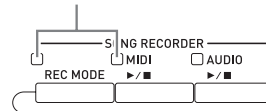

### NOTE

- You can also enter the recording mode by pressing the **3** REC MODE button and then touching “MIDI RECORDER”. This method can be used to enter the recording mode only for making a new recording.
- Recording memory capacity is approximately 50,000 notes per song. When remaining capacity is 100 or fewer notes, the **4** MIDI ▶/■ button lamp will flash at high speed. Recording will stop automatically when the allowable limit is reached.

### IMPORTANT!

- The Digital Piano has memory for 100 songs.
- If power to the Digital Piano is cut off while recording is in progress, everything you recorded up to that point will be lost. Take care so power is not turned off accidentally during recording operations.

## To record to a specific track (Part)

You can record specific instruments, the left hand and right hand, or other parts of a song individually, and then combine them into a final song.

### ■ What is a track?

A “track” is a separate recorded part of a song. The MIDI Recorder of this Digital Piano has a total of 17 tracks, one of which is a system track as described below.

#### ● System Track

In addition to notes you play on the keyboard and other performance operation data, the system track also includes a wide range of setup information for the song, including layer on/off, split on/off, tempo, Auto Accompaniment settings, reverb type, etc. When you record a single-track song to recorder memory, as shown under “Recording to Digital Piano Memory (MIDI Recorder)” (page EN-56) everything is recorded to the system track.

#### ● Tracks 01 through 16

These tracks can be used to record notes, as well as pitch bend wheel and pedal operations, and the keyboard tone setting. These tracks can be combined with the system track and each other to create the final song.

### ■ Supported Track Data

The following describes the data that can be recorded to each type of track.

#### System Track, Tracks 01 through 16

Keyboard performance\*<sup>1</sup>, the keyboard tone setting\*<sup>1</sup>, pedal and pitch bend wheel operation, mixer settings (except for part on/off), part manipulation by a controller

#### System Track only

Rhythm, balance setting, effect setting (reverb, chorus, delay), tempo, Auto Accompaniment performance/setting, one-touch preset, music preset performance\*<sup>2</sup>, registration\*<sup>2,3</sup>, system manipulation by a controller\*<sup>4</sup>

\*1 Upper 1 only for Tracks 1 through 16

\*2 Recall only

\*3 The Auto Accompaniment volume level and transpose setting of the recalled data is not included in the recording.

\*4 However, the settings of functions such as Master Comp and Master EQ are not recorded.

1. Record the first part to the system track.
  - Use the procedure under “Recording to Digital Piano Memory (MIDI Recorder)” (page EN-56) to record to the system track.
2. Next, select the tone of the part you want to play and record.
3. On the MENU screen, touch “MIDI RECORDER”.
4. Touch “●” to enter the recording mode.
5. Touch the track name.

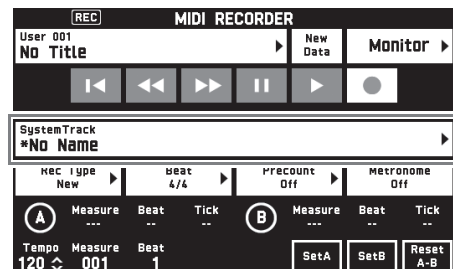

6. Touch the track (Solo Track 1 through Solo Track 16) you want to record.
7. Start playing something on the keyboard.

This starts recording along with playback of what you recorded to the system track, so you can play along with system track.

## 8. After you are finished playing, touch “■”.

This enters the playback mode. Touch “▶” to play back what you recorded up to this point. To stop playback, touch “■”.

- You can use the following procedure to turn specific tracks on (play enabled) and off (play disabled). This allows you to listen only to the track(s) you want when recording a new track.

- Touch “Monitor”.  
This displays the MIDI Recorder playback properties screen.
- You can select “Mute” or “Solo” for each of the tracks.  
Mute: Track is not played.  
Solo: Selected track is played alone.

You can mute specific recorded tracks so they do not play as you record a new track.

## 9. Repeat steps 2 through 8 above as required to record all of the parts you need to complete your song.

### NOTE

- You can re-record the currently selected track without changing any settings. Simply touch “Rec Type” on the screen that is displayed in the recording mode, and then select “Re-Recording”.

### To re-record part of a recorder song (Punch-in Recording)

You can use punch-in recording to re-record a specific part of recorder song that you want to improve or correct.

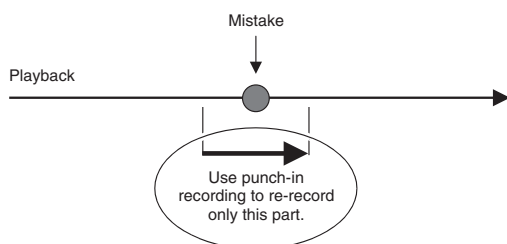

## 1. Enter the MIDI recorder recording mode and then select the track where you want to perform punch-in recording.

- For information about how to select a track, see steps 4 and 5 under “To record to a specific track (Part)” (page EN-57).

## 2. Touch “Rec Type”.

## 3. Touch “Punch In Sync”.

- If you want to delete all of the data in the track following the section you recorded with punch-in recording, touch “Punch Out Erase”.

## 4. Touch “▶”.

This will start playback of the selected track.

## 5. When playback reaches the point you want to re-record, play the desired note(s) on the keyboard.

This starts punch-in recording, so continue to play.

- Performing a pedal or pitch bend wheel operation also will start punch-in recording.
- Besides keyboard play, you can also start punch-in recording by performing the operation below.  
Touch “Punch In”<sup>\*1</sup>, change the tone, change the rhythm<sup>\*2</sup>, change the tempo<sup>\*2</sup>.

<sup>\*1</sup> Used when you want to start punch-in recording without modifying play or settings.

<sup>\*2</sup> System track only

- During punch-in playback, you can touch “◀◀” to skip back or “▶▶” to skip forward. This lets you jump more quickly to the location you want to record. You can also pause playback by touching “||”.

## 6. After you are finished punch-in recording, touch “■”.

Anything in the track following the point where you touched “■” will be retained as-is.

- If you want to cancel punch-in recording part way through and retain the original track data, touch “Cancel Punch”.

## To re-record a specific range (Auto Punch-in Recording)

You can use the following procedure to specify a particular range for punch-in recording.

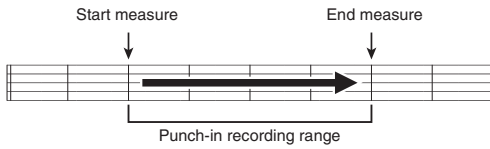

1. Enter the MIDI recorder recording mode and then select the song that contains the section you want to re-record.
2. Use “◀◀” and “▶▶” to display the first measure of the section you want to record and then touch “Set A”.

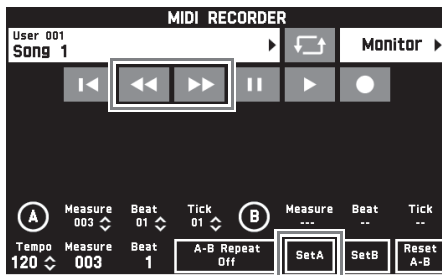

3. Use “◀◀” and “▶▶” to display the last measure and then touch “Set B”.
  4. Touch “◀” to return to the beginning of the song, or use “◀◀” and “▶▶” to adjust the position to start playback.
  5. Touch “●”.
- This enters record standby.
6. Touch “Rec Type”.
  7. Touch “Punch In A-B”.
  8. Touch “▶”.
- Punch in recording will start from the start measure and stop with the end measure automatically.

## To re-record an area smaller than one measure

Use the procedure below to specify a punch-in recording area that includes a part of a measure.

*Example:* To re-record from beat 3 of measure 2 up to beat 1 of measure 4

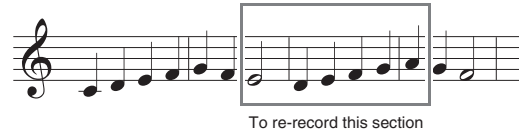

1. Use the MIDI Recorder to start playback of the song that contains the section you want to re-record.
  2. When playback reaches the point where you want to start punch-in recording, touch “Set A”.
- After touching “Measure”, “Beat”, or “Tick” for Point A, you can then use the **19** ↓, ↑ buttons to make fine adjustments to the start point.

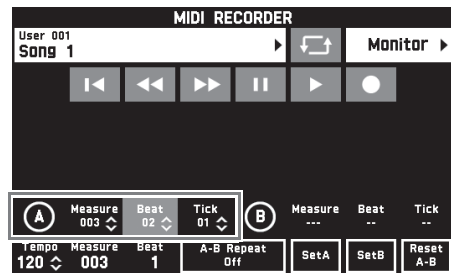

3. When playback reaches the point where you want to end punch-in recording, touch “Set B”.
- After touching “Measure”, “Beat”, or “Tick” for Point B, you can then use the **19** ↓, ↑ buttons to make fine adjustments to the end point.

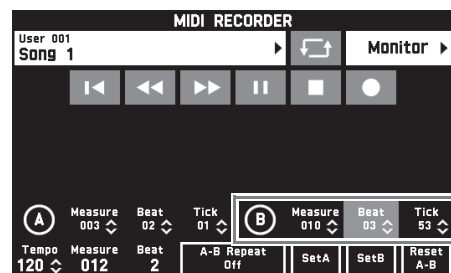

4. Touch “■” to stop play back.

5. Touch “⏮” to return to the beginning of the song, or use “◀◀” and “▶▶” to adjust the position to start playback.
6. Touch “●” to enter the recording mode and select the track where you want to perform punch-in recording.
  - For information about how to select a track, see steps 4 and 5 under “To record to a specific track (Part)” (page EN-57).
7. Touch “Rec Type”.
8. Touch “Punch In A-B”.
9. Touch “▶”.

  - Punch-in recording automatically starts when playback reaches the start point and ends when it reaches the end point you specified in step 3.

### To play MIDI data

You can use the procedure below to perform auto play of MIDI data (MIDI recording data or SMF files) stored in Digital Piano memory or on a USB flash drive, and practice along on the keyboard.

- For information about loading a USB flash drive on the Digital Piano and importing MIDI data to Digital Piano memory, see “Loading Data from a USB Flash Drive to Digital Piano Memory” (page EN-85).

1. On the MENU screen, touch “MIDI RECORDER”.  
This displays a MIDI RECORDER screen.

2. Touch the file name.

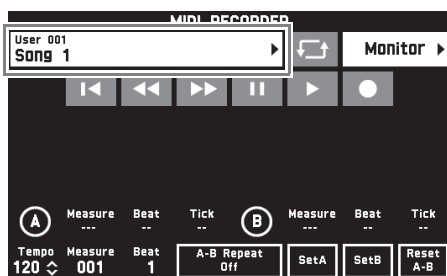

3. Touch the “User” tab to play back MIDI data stored in Digital Piano memory or the “Media” tab to play back from a USB flash drive.
4. Touch the MIDI data you want to play.

5. Touch “▶”.

This starts playback.

- You can also start playback by pressing the **4** MIDI ▶/■ button.
- The operations below are supported while MIDI data is playing back, during playback standby, or while playback is paused.

This icon:	Does this:
↺	Performs repeat play. Each touch of an icon cycles the setting in the following sequence: 1 song repeat → All song repeat → Off.
⏮	Returns to the beginning of a song.
◀◀	Rewinds. A single touch rewinds one measure, holding down performs continuous rewind.
▶▶	Fast forwards. A single touch fast forwards one measure, holding down performs continuous fast forward.
⏸	Pauses or resumes the currently playing MIDI data. The icon flashes while playback is paused.
▶/■	Starts playback MIDI data or stops playback.
●	Toggles between the recording mode and playback mode.

6. To stop playback, touch “■”.

- You can also stop playback by pressing the **4** MIDI ▶/■ button.

## To adjust the Balance between Playback and Keyboard Volume (MIDI Volume)

You can change the volume level of the MIDI data auto play only, without affecting the volume of the keyboard. For details, see “BALANCE Screen” under “Configuring Digital Piano Settings” (pages EN-68 through EN-81).

## To repeat playback of a specific section (Repeat)

You can configure the piano to repeat the section of a song you want to practice. You could, for example, specify repeat play from measure 5 to measure 8.

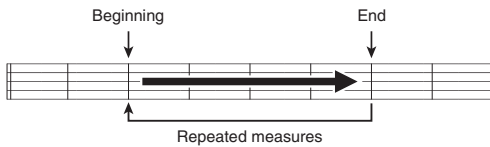

### 1. Touch “▶”.

This starts auto play.

### 2. When play reaches the beginning of the section you want to repeat, touch “Set A”.

This makes the measure where you touched “Set A” the “start measure”.

- You can also make fine adjustments to the start point. After touching “Measure”, “Beat”, or “Tick” for Point A, you can then use the **19**  $\downarrow$ ,  $\uparrow$  buttons to adjust.

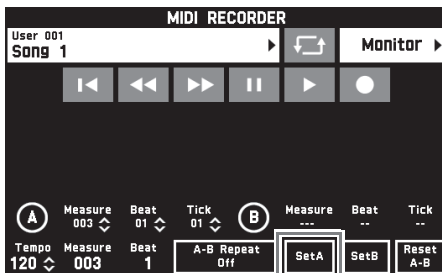

### 3. When play reaches the end of the section you want to repeat, touch “Set B”.

This makes the measure where you touched “Set B” the “end measure”.

- You can also make fine adjustments to the end point. After touching “Measure”, “Beat”, or “Tick” for Point B, you can then use the **19**  $\downarrow$ ,  $\uparrow$  buttons to adjust.

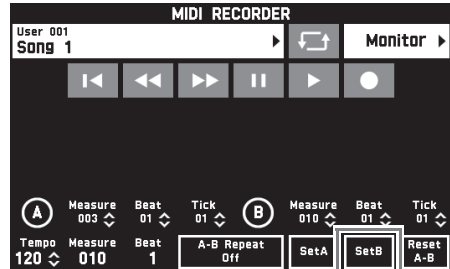

### 4. Touch “A-B Repeat” to enable repeat playback.

This starts repeat playback of the specified section.

### 5. To disable repeat playback, touch “A-B Repeat” again, which will return to normal playback.

#### **NOTE**

- To clear the start measure and end measure settings, touch “Reset A-B”.

### To rename recorded MIDI data

---

1. On the MENU screen, touch "MIDI RECORDER".
2. Touch the data name.
3. Touch "User Data Edit".
4. Touch "Rename".
5. Touch the data you want to rename.
6. Input the new name.
7. After you are finished inputting the name, touch "Enter".
8. Touch "Yes".
  - To cancel the rename operation, touch "No".

### To copy recorded MIDI data

---

1. On the MENU screen, touch "MIDI RECORDER".
2. Touch the data name.
3. Touch "User Data Edit".
4. Touch "Copy".
5. Touch the data you want to copy.
6. Touch "Execute".
7. Touch "Yes".
  - To cancel the copy operation, touch "No".

### To delete recorded data

---

1. On the MENU screen, touch "MIDI RECORDER".
2. Touch the data name.
3. Touch "User Data Edit".
4. Touch "Delete".
5. Touch the data you want to delete.
6. Touch "Execute".
7. Touch "Yes".

This deletes the MIDI data you selected.

  - To cancel the delete operation, touch "No".

### To rename a track

---

1. On the MENU screen, touch "MIDI RECORDER".
2. Touch "Monitor".
3. Touch "Edit".
4. Touch "Rename".
5. Touch the track you want to rename.
6. Input the new name.
7. After you are finished inputting the name, touch "Enter".
8. Touch "Yes".
  - To cancel the rename operation, touch "No".



### To copy one track to another

1. On the MENU screen, touch “MIDI RECORDER”.
2. Touch “Monitor”.
3. Touch “Edit”.
4. Touch “Copy”.
5. In the “Source” list, touch the track you want to copy.
6. In the “Destination” list, touch the destination track.
7. Touch “Execute”.
8. Touch “Yes”.
  - To cancel the copy operation, touch “No”.

### To clear a track

1. On the MENU screen, touch “MIDI RECORDER”.
2. Touch “Monitor”.
3. Touch “Edit”.
4. Touch “Clear”.
5. Touch the track you want to clear.
6. Touch “Execute”.
7. Touch “Yes”.
  - To cancel the delete operation, touch “No”.

### To insert a blank measure at a specific position in a specific track

1. On the MENU screen, touch “MIDI RECORDER”.
2. Touch “Monitor”.
3. Touch “Edit”.
4. Touch “Insert Measure”.
5. Touch the track into which you want to insert a blank measure.
6. Touch the item whose setting you want to change, and then use the **19** ,  buttons to change it.

Measure: Specifies the measure number from which insertion starts.

Size: Specifies the number of measures to be inserted.
7. After you are finished configuring settings, touch “Execute”.
8. Touch “Yes”.
  - To cancel the insert operation, touch “No”.

#### NOTE

- If a Point A and Point B are specified using the procedure under “To repeat playback of a specific section (Repeat)” (page EN-61) before performing this operation “Measure” and “Size” settings will be configured automatically.



## To delete a specific measure from a specific track

1. On the MENU screen, touch “MIDI RECORDER”.
2. Touch “Monitor”.
3. Touch “Edit”.
4. Touch “Delete Measure”.
5. Touch the track that contains the measure you want to delete.
6. Touch the item whose setting you want to change, and then use the **19**  $\downarrow$ ,  $\uparrow$  buttons to change it.  
Measure: Specifies the measure number from which delete starts.  
Size: Specifies the number of measures to be deleted.
7. After you are finished configuring settings, touch “Execute”.
8. Touch “Yes”.
  - To cancel the delete operation, touch “No”.

### NOTE

- If a Point A and Point B are specified using the procedure under “To repeat playback of a specific section (Repeat)” (page EN-61) before performing this operation “Measure” and “Size” settings will be configured automatically.

## To quantize a specific step\*

\* Quantize is an operation that automatically adjusts the timing of the note on operation of each step to match a reference note.

1. On the MENU screen, touch “MIDI RECORDER”.
2. Touch “Monitor”.
3. Touch “Edit”.
4. Touch “Quantize”.
5. Touch the track you want to quantize.
6. Touch the note icon.
7. Touch the note you want to use as the quantize reference note.
8. Touch the item whose setting you want to change, and then use the **19**  $\downarrow$ ,  $\uparrow$  buttons to change it.  
Measure: Specifies the measure number from which quantize starts.  
Size: Specifies the number of measures to be quantized.
9. Touch “Execute”.
10. Touch “Yes”.
  - To cancel the quantize operation, touch “No”.

### NOTE

- If a Point A and Point B are specified using the procedure under “To repeat playback of a specific section (Repeat)” (page EN-61) before performing this operation “Measure” and “Size” settings will be configured automatically.

## To key shift a specific measure from a specific track

1. On the MENU screen, touch “MIDI RECORDER”.
2. Touch “Monitor”.
3. Touch “Edit”.
4. Touch “Key Shift”.
5. Touch the track you want to key shift.
6. Touch the item whose setting you want to change, and then use the **19**  $\nabla$ ,  $\wedge$  buttons to change it.
 

Shift: Specifies the extent of the key shift. You can specify a value in the range of -24 to +24.

Measure: Specifies the measure number from which key shift starts.

Size: Specifies the number of measures to be key shifted.
7. After you are finished configuring settings, touch “Execute”.
8. Touch “Yes”.
  - To cancel the key shift operation, touch “No”.

### NOTE

- If a Point A and Point B are specified using the procedure under “To repeat playback of a specific section (Repeat)” (page EN-61) before performing this operation “Measure” and “Size” settings will be configured automatically.

## Recording to a USB Flash Drive (Audio Recorder)

Anything played on the Digital Piano is recorded to the USB flash drive as audio data (WAV files\*). If you play along on the Digital Piano as you play back data stored in Digital Piano memory, the memory playback and your keyboard play are both recorded to USB flash drive.

\* Linear PCM, 16bit, 44.1 kHz, Stereo

- Each new recording of audio data to a USB flash drive is automatically assigned a new file name, so existing data is not overwritten.
- Never remove the USB flash drive while Audio Recorder recording or playback is in progress. Doing so can corrupt the data on the USB flash drive and damage the USB flash drive port.

## To record keyboard play to a USB flash drive

### PREPARATION

- Be sure to format the USB flash drive on the Digital Piano before using it. See “USB Flash Drive” on page EN-82 for more information.

1. Insert the USB flash drive into the Digital Piano’s USB flash drive port.
  - When you perform a USB flash drive operation or turn on the Digital Piano while a USB flash drive is plugged in, the Digital Piano initially needs to perform a “mounting” sequence to prepare for data exchange with the USB flash drive. Digital Piano operations may be momentarily disabled while a mounting sequence is being performed. While the mounting process is in progress, the message “Media Mounting” will be displayed on the display. It may take up to 10 or 20 seconds or even longer for a USB flash drive to be mounted. Do not attempt to perform any operation on the Digital Piano while a mounting sequence is in progress. A USB flash drive needs to be mounted each time it is connected to the Digital Piano.
2. On the MENU screen, touch “AUDIO RECORDER”.

### 3. Touch “●”.

This turns on the recorder and enters recording mode.

- Each touch of “●” cycles through modes as shown below.

Playback mode

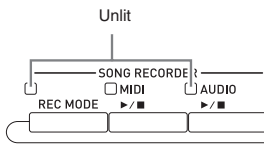
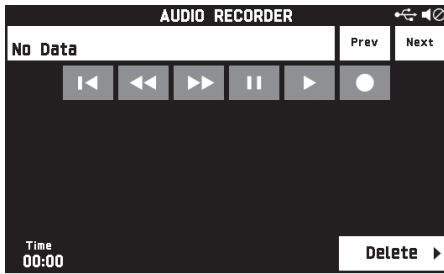

Recording mode

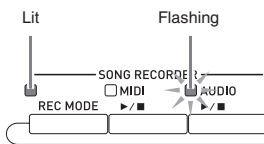
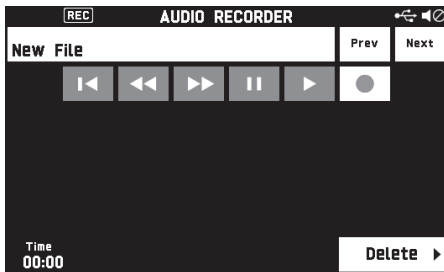

### 4. Start playing something on the keyboard.

This will cause recording to the USB flash drive to start.

- You can also start recording by touching “▶”.
- The **5** AUDIO ▶/■ button is lit while recording is in progress.

#### NOTE

- Do not remove the USB flash drive from the USB flash drive port while the **5** AUDIO ▶/■ button lamp is lit or flashing. Doing so will interrupt recording and may corrupt data.

### 5. To stop recording, touch “■”.

#### NOTE

- You can also enter the recording mode by pressing the **3** REC MODE button and then touching “AUDIO RECORDER”.

### To record keyboard play with playback from Digital Piano memory

1. On the MENU screen, touch “AUDIO RECORDER”.
2. Touch “●” to enter the recording mode.

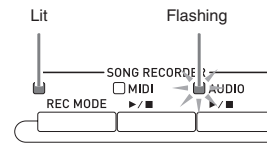

### 3. Touch “▶”.

### 4. Press the **4** MIDI ▶/■ button.

- This starts playback of the Digital Piano’s memory contents. Play along on the keyboard.

### 5. To stop recording, touch “■”.

## To play along with data recorded on a USB flash drive

1. On the MENU screen, touch “AUDIO RECORDER”.
  - The above step is not necessary if you are playing back recorded data immediately after recording it (while the AUDIO RECORDER screen is displayed).

2. Touch the file name.

This displays the audio file selection screen.



3. Touch the song you want to play.

4. Touch “▶”.

This starts playback of the selected song.

- You can also start playback by pressing the **5** AUDIO ▶/■ button.
- The **5** AUDIO ▶/■ button is flashing while playback is in progress.
- The operations below are supported while audio data is playing back, during playback standby, or while playback is paused.

Note that rewind (◀◀) and fast forward (▶▶) operations are supported only while audio data is playing back or while playback is paused.

This icon:	Does this:
Prev	Plays the previous audio data.
Next	Plays the next audio data.
◀◀	Returns to the beginning of a song.
◀◀	Rewinds. A single touch rewinds one second, holding down performs continuous rewind.
▶▶	Fast forwards. A single touch fast forwards one second, holding down performs continuous fast forward.
	Pauses or resumes the currently playing audio data. The icon flashes while playback is paused.
▶/■	Starts playback from the beginning of audio data or stops playback.
●	Toggles between the recording mode and playback mode.

5. To stop the song, touch “■”.

- You can also stop playback by pressing the **5** AUDIO ▶/■ button.

## To delete an audio file from a USB flash drive

Files can be deleted one at time.

### ! IMPORTANT!

- The procedure below deletes all of the data of the selected song. Note that the delete operation cannot be undone. Check to make sure you really do not need the data in Digital Piano memory before you perform the following steps.

1. On the MENU screen, touch “AUDIO RECORDER”.

2. Touch the file name.

3. Touch “Delete”.

4. Touch the data you want to delete.

5. Touch “Execute”.

6. Touch “Yes”.

This deletes the audio data you selected.

- To cancel the delete operation, touch “No”.

# Configuring Digital Piano Settings

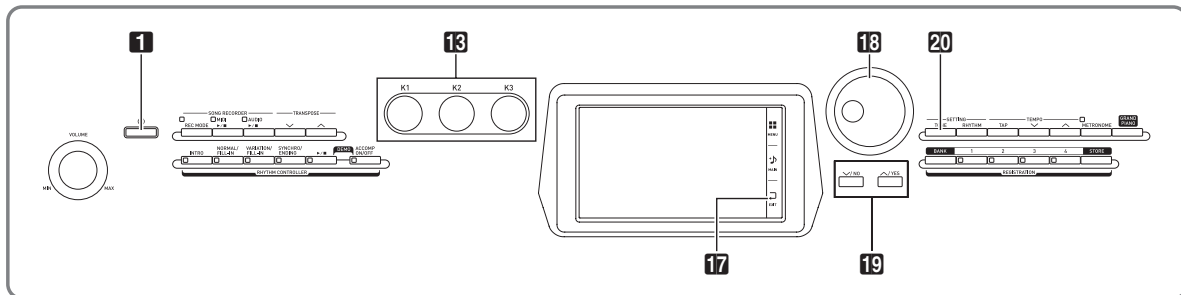

On the MENU screen, you can change the selected tone and rhythm, and also change the keyboard key and touch settings, pedal and MIDI settings, and more. This means you can tailor Digital Piano operation to suit your particular needs.

## Configuring Digital Piano Settings

1. On the MENU screen, touch the menu for the settings you want to configure.

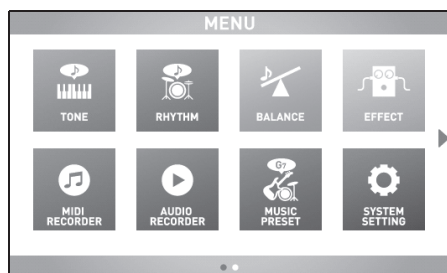

2. Touch the item whose setting you want to change.
3. Use the **18** Dial or the **19**  $\downarrow$ ,  $\uparrow$  buttons to change the setting.

## ■ TONE Screen

Use this screen to configure tone and other keyboard settings.

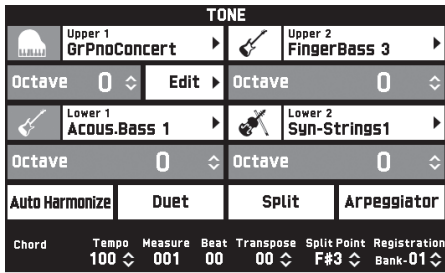

### NOTE

- You can also display the TONE screen by pressing the **20** TONE button.

Item	Description	Setting
Upper 1, Upper 2, Lower 1, Lower 2	Turns each part on or off, and specifies its tone.	Off, On
Edit	See page EN-23.	–
Octave	Change the range of each part in octave units.	-2 to 0 to 2
Auto Harmonize	See page EN-42.	Off, On
Duet	See page EN-17.	Off, On
Split	See page EN-16.	Off, On
Arpeggiator	Turns the arpeggiator on or off.	Off, On

## ■ RHYTHM Screen

Use this screen to configure Auto Accompaniment settings. See “Using Auto Accompaniment” (page EN-38) for more information.

## ■ BALANCE Screen

Use this screen to adjust volume settings for the keyboard, Auto Accompaniment, etc.

BALANCE			
Parameter	Setting	Parameter	Setting
Upper 1 Volume	127 ⇅	Upper 2 Volume	127 ⇅
Lower 1 Volume	127 ⇅	Lower 2 Volume	127 ⇅
Keyboard Volume	127 ⇅	Accomp Volume	127 ⇅
MIDI Volume	127 ⇅	Metronome Volume	100 ⇅
Audio Volume	127 ⇅		
Line In Volume	127 ⇅		

Item	Description	Setting
Upper 1 Volume	See page EN-19.	0 to 127
Upper 2 Volume	See page EN-19.	0 to 127
Lower 1 Volume	See page EN-19.	0 to 127
Lower 2 Volume	See page EN-19.	0 to 127
Keyboard Volume	Adjusts the volume levels of all parts that are controlled by the keyboard.	0 to 127
Accomp Volume	Adjusts the volume level of the Auto Accompaniment without changing the keyboard tone volume level.	0 to 127
MIDI Volume	Adjusts the volume level of the MIDI data without changing the keyboard tone volume level.	0 to 127
Audio Volume	Adjusts the volume level of audio data stored on a USB flash drive.	0 to 127
Line In Volume	Adjusts the volume of <b>LINE IN</b> terminal input.	0 to 127
Metronome Volume	See page EN-19.	0 to 127

## ■ EFFECT Screen

Use this screen to apply variety of acoustic effects to notes.

Your Digital Piano has three types of effects, each of which includes the effects described below.

### A) Digital Signal Processor (DSP)

A collection of versatile Normal DSP effects help to enhance the sound of tones. For example, distortion can be applied to an electric guitar sound to make it sound more powerful. There are 20 different Normal DSP types, and the most appropriate one for the selected tone is applied automatically.

### B) System Effects (SYSTEM)

These effects are shared by all Digital Piano parts. The depth of an effect can be adjusted by specifying the send level from the part to each system effect.

- Chorus (Chorus): Combines multiple layers of the same note to create a sound with more depth.
- Delay (Delay): Delays the input signal and feeds it back to create a repeating effect and give notes more breadth.
- Reverb (Reverb): Adds reverberation to make it sound like you are playing in a room or in a hall.
- Acoustic Simulator (Acoustic Simulator): Simulates the resonance of acoustic piano strings. String Resonance (String Reso): Generates resonance for the strings of keys being pressed. Damper Resonance (Damper Reso): Generates string resonance when the damper pedal is pressed. Note that use of string resonance and damper resonance is supported only for certain tones.

### C) Master Effects (MASTER)

These effects are applied to the Digital Piano master output signal.

- Equalizer (Master Equalizer (EQ)): Adjusts the master frequency characteristics. The Master Equalizer can be used to adjust the frequency and gain of four frequency bands: low, mid1, mid2, and high.
- Compressor (Master Compressor): Compresses the instrument master output signal. This effect can be used to suppress level dispersion and limit the level of the input signal so it does not exceed the setting value.

Parameter	EFFECT Setting	
Reverb Edit	Enter ▶	⏶
Chorus Edit	Enter ▶	1/2
Delay Edit	Enter ▶	
Master Comp Edit	Enter ▶	
Master EQ Edit	Enter ▶	
Acoustic Simulator	Enter ▶	

Item	Description	Setting
Reverb Edit		
Reverb Type	Selects the reverb type.	Room1, Room2, Room3, Hall1, Hall2, Hall3, Plate1, Plate2, Plate3, Delay, Pan Delay, Large Room1, Large Room2, Stadium1, Stadium2, Long Delay1, Long Delay2
Time	Adjusts the reverb time.	0 to 127
Early Reflection	Adjusts the level of the initial reflection.	0 to 127
High Damp	Adjusts the high-range damp. A smaller number increases damping.	0 to 127
Tone	Adjusts the tone.	0 to 127
Return	Adjusts the return level.	0 to 127



Item	Description	Setting
<b>Chorus Edit</b>		
Chorus Type	Selects the chorus type.	Chorus1, Chorus2, Chorus3, Chorus4, FB Chorus, Flanger1, Flanger2, Flanger3, Flanger4, Short Delay1, Short Delay2, Short Delay3, Short Delay4, Soft Chorus, Bright Chorus, Deep Chorus
LFO Rate	Adjusts the LFO rate.	0 to 127
LFO Depth	Adjusts the LFO depth.	0 to 127
Feedback	Adjusts the feedback amount.	0 to 127
Tone	Adjusts the tone.	0 to 127
Delay Time	Adjusts the delay time.	0 to 127
Delay Send	Adjusts the send level to system delay.	0 to 127
Reverb Send	Adjusts the send level to system reverb.	0 to 127
Return	Adjusts the return level.	0 to 127
<b>Delay Edit</b>		
Delay Type	Selects the delay type.	Short 1, Short 2, Echo, Short Tempo, Mid Tempo, Long Tempo
Time	Adjusts the total delay time.	0 to 127
Feedback	Adjusts the feedback amount of the center channel.	0 to 127
High Damp	Adjusts the high-range damp. A smaller number increases damping.	0 to 127
Ratio L	Adjusts the ratio of the left channel relative to the total delay time.	0 to 127
Ratio C	Adjusts the ratio of the center channel relative to the total delay time.	0 to 127
Ratio R	Adjusts the ratio of the right channel relative to the total delay time.	0 to 127
Level L	Adjusts the level of the left channel.	0 to 127
Level C	Adjusts the level of the center channel.	0 to 127
Level R	Adjusts the level of the right channel.	0 to 127
Tempo Sync	Specifies how the actual total delay time is synced with tempo. Off: Uses Delay Time value. 1/4 to 2: Uses value in accordance with number of beats.	Off, 1/4, 1/3, 3/8, 1/2, 2/3, 3/4, 1, 4/3, 3/2, 2
Reverb Send	Adjust the send level to system reverb.	0 to 127
Return	Adjusts the return level.	0 to 127
<b>Master Comp Edit</b>		
Threshold	Adjusts the threshold (where application of an effect starts) level. Set a lower value for a compressor effect, and a higher value for a limiter effect.	0 to 127
Ratio	Adjusts the compression ratio. Set a lower value to for a compressor effect, and the maximum value to for a limiter effect.	0 to 127
Level	Adjusts the output level.	0 to 127
Attack	Adjusts the time until the compression effect starts. A smaller value causes prompt compressor operation, which suppresses the attack of the input signal. A larger values delays compressor operation, which causes the attack of the input signal to be output as-is.	0 to 127

Item	Description	Setting
Release	Adjusts the release time. Adjusts the time until the compression effect is released.	0 to 127
Position	Selects the connection position with the compressor EQ.	PreEQ, PostEQ
Master EQ Edit	See page EN-81.	
Acoustic Simulator		
Hammer Response	Controls the time deviation between when a key is pressed and the note actually sounds.	0 to 7: A greater value produces slower timing.
Damper Resonance	Adjusts the damper resonance send level.	0 to 15: A greater value increases the send level.
String Resonance	Adjusts the string resonance that is characteristic of an acoustic piano.	0 to 15: A larger value increases the resonance level.
Damper Noise Level	Specifies the noise volume output when the damper pedal is pressed.	0 to 15: A greater value increases the noise volume.
SysFX Bypass	Temporarily disables (bypasses) system effects.	Off, On
MasFX Bypass	Temporarily disables (bypasses) master effects.	Off, On
DSP Bypass	Temporarily disables (bypasses) DSP effects.	Off, On

### ■ MIDI RECORDER Screen

Use this screen to record a performance to Digital Piano memory and to play back recordings. For more information, see “Recording to Digital Piano Memory (MIDI Recorder)” (page EN-56).

### ■ AUDIO RECORDER Screen

Use this screen to record a performance on a commercially available USB flash drive, and to play back recorded audio data on the Digital Piano. For more information, see “Recording to a USB Flash Drive (Audio Recorder)” (page EN-65).

### ■ MUSIC PRESET Screen

Music presets provide you with one-touch tone, rhythm, chord, and other settings that are optimized for specific musical genres and songs. In addition to built-in presets, you can create your own original music presets (user presets). For more information, see “Music Presets” (page EN-46).

## ■ SYSTEM SETTING Screen

Use this screen to configure global Digital Piano settings.

SYSTEM SETTING		
Parameter	Setting	
Speaker	On	⤴
Touch Response	Normal	▶
Touch Off Velocity	100	◇
Metronome Beat	4	◇
Tuning	440.0	◇
Temperament	Equal	▶

1/3

Item	Description	Setting
Speaker	Specifies whether sound should be output from the Digital Piano speakers (On) or muted (Off).	Off, On
Touch Response	Adjusts keyboard touch	Off: Disabled Light: Strong sound even with light pressure Normal: Normal key touch Heavy: Normal sound even with strong pressure
Touch Off Velocity	Specifies the velocity value when the Touch Response setting is Off.	0 to 127
Metronome Beat	Specifies the number of metronome beats per measure.	0 to 9
Tuning	Raises or lowers the overall pitch of the Digital Piano from the standard pitch of A4 = 440 Hz in 0.1Hz units.	415.5Hz to 440.0Hz to 465.9Hz
Temperament	Changes the temperament of the keyboard and Auto Accompaniment from the standard equal temperament to another tuning more suitable for playing classics, Arabian music, etc.	Equal, Pure Major, Pure Minor, Pythagorean, Kimberger 3, Werckmeister, Mean-Tone, Rast, Bayati, Hijaz, Saba, Dashti, Chahargah, Segah, Gurjari Todi, Chandrakauns, Charukeshi
Temperament Base Note	Pressing a keyboard key makes the pressed key the root of the temperament.	C to B (12 types)
Acmp Temperament	Turn this setting off to play Auto Accompaniment using standard equal temperament, regardless of the current scale setting selected with the Temperament Base Note parameter above.	Off, On
Stretch Tuning	Sharpens high notes and flattens low notes to achieve stretch tuning. This type of tuning is called "stretch tuning". Turn off this setting to play with normal (non-stretch) tuning.	Off, On
Brightness	Use this item to adjust display brightness.	1 to 13
N. Gate Thresh	Cuts <b>LINE IN</b> terminal input sound that is below a preset level, which reduces noise. A larger setting value raises the sound cutoff level.	1, 2, 3
Int By Wave	Select "On" to link the envelope and other parameters when a wave is selected or "Off" not to link.	Off, On
Operation Lock	When this setting is turned on, the Digital Piano's buttons (except for the <b>1</b>  button and buttons required for unlock) are locked, so no operation can be performed. Turn on operation lock when you want to protect against unintentional button and control panel operations.	Off, On

Item	Description	Setting
Auto Resume	When "On" is selected for this setting, the Digital Piano will remember its settings whenever it is turned off, and restore them when it is turned on again. When "Off" is selected, settings are reset to their initial defaults whenever the Digital Piano is turned on.	Off, On
Auto Power Off	Specifies if Auto Power Off (page EN-8) is enabled (On) or disabled (Off).	Off, On
Exp.pedal Calibration	Performs an expression pedal calibration operation. 1. When the message "Move the expression pedal to the highest position and Press "OK"" appears, press the pedal and then touch "OK". 2. When the message "Move the expression pedal to the lowest position and Press "OK"" appears, release the pedal and then touch "OK". The message "Complete" will appear on the display when the operation is complete. • Touch <b>17</b> EXIT to exit the calibration operation.	-
Factory Reset	Use this screen to return the piano's stored data and settings to their initial factory defaults.	-
Information	Shows the version of the firmware installed on the Digital Piano. Also use this item when updating the Digital Piano firmware.	-

## ■ CONTROLLER Screen

Use this to configure pedal and pitch bend wheel settings.

CONTROLLER		
Parameter	Setting	
Knob1 Edit	Enter ▶	⤴
Knob2 Edit	Enter ▶	1/2
Knob3 Edit	Enter ▶	
Modulation Edit	Enter ▶	
Pedal Edit	Enter ▶	
Pedal Type	Foot Switch ▶	

Item	Description	Setting
Knob1-3 Edit	This is a group editable parameters for <b>13</b> knobs (K1 to K3).	
Target	<p>Selects the parameters to be controlled by a controller. For example, the “CC67:Soft” setting specifies a soft pedal effect.</p> <ul style="list-style-type: none"> <li>Two targets can be specified for a single controller.</li> </ul> <p>No Assign: No target specified.            CC00 to CC97: MIDI control change*1            NRPN, RPN: MIDI NRPN and RPN parameters*1 *2            Pressure: MIDI channel pressure*1            Tempo: Tempo setting (page EN-20)            EQ Low Gain - EQ High Gain: Master EQ &gt;Low Gain - High Gain (page EN-81)            Upper 1 On/Off to Lower 2 On/Off: On/Off setting of each tone            Upper 1 Volume to Metronome Volume: Balance adjustment of keyboard, Auto Accompaniment, and other volume levels            Layer Detune: Layer detune (page EN-33)            Layer 1 - Layer 6: Tone parameter settings of each layer</p> <ul style="list-style-type: none"> <li>The following can be assigned: On/Off, Volume (Volume), Pan (panning), OctShift (octave shift), DspOnOff (DSP on/off), LfoPitch (LFO pitch), LfoFiltr (LFO filter), LfoAmp (LFO amp). For details about each setting, see the editable parameters under “Editing a Tone” (page EN-23).</li> </ul> <p>DSP Bypass: Temporarily bypasses the DSP.            Dsp Param 1-16: DSP parameters            SysFX Bypass: Temporarily bypasses system effects.            MasFX Bypass: Temporarily bypasses master effects.</p> <p>*1 For details about each setting, see the MIDI Implementation Chart and/or MIDI documentation.            *2 After selecting these parameters, adjust the parameters below.            MSB: CC99 for NRPN, CC101 for RPN (Setting range: 000 to 127)            LSB: CC98 for NRPN, CC100 for RPN (Setting range: 000 to 127)            Data Entry MSB/LSB: Specifies which Data Entry (MSB (CC06) or LSB (CC38)) is controlled by a controller operation. (Settings: MSB, LSB)</p>	Refer to the information to the left.
Min Value	Controller minimum output value setting.	0 to 127
Max Value	Controller maximum output value setting.	0 to 127
Upper1 Enable	Turning on this setting applies output MIDI messages to the Upper1 tone.	Off, On
Upper2 Enable	Turning on this setting applies output MIDI messages to the Upper2 tone.	Off, On
Lower1 Enable	Turning on this setting applies output MIDI messages to the Lower1 tone.	Off, On
Lower2 Enable	Turning on this setting applies output MIDI messages to the Lower2 tone.	Off, On
Auto Resolution (Knobs 1, 2, 3 only)	Turning on this setting causes the amount of change applied when a knob is rotated to be in accordance with the “Target”, “Min Value”, and “Max Value” settings. When this setting is off, each click of a knob changes the applicable setting by one.	Off, On
Modulation Edit	This is a group of <b>33</b> MODULATION wheel editable parameters. Details of the editable parameters are the same as “Knob1 Edit”, above.	

Item	Description	Setting
Pedal Edit	This is a group of editable parameters for the pedal connected to the <b>ASSIGNABLE PEDAL</b> terminal. Details of the editable parameters are the same as "Knob1 Edit", above.	
Pedal Type	Specifies whether the pedal connected to the <b>ASSIGNABLE PEDAL</b> jack is to be used as a foot switch or an expression pedal. Do not change this setting while the pedal is depressed.	Foot Switch, Exp. Pedal
Pedal Mode	Selects the operation performed when the pedal is pressed. Momentary: On while the pedal is depressed, off while the pedal is released. Toggle: On after the pedal is pressed and remains on even if the pedal is released. Off when the pedal is pressed again.	Momentary, Toggle
Upper1 Pedal	Turning on this setting applies the effect to the main tone when the pedal connected to the <b>DAMPER PEDAL</b> terminal or pedal connector is depressed.	Off, On
Upper2 Pedal	Turning on this setting applies the effect to the layer tone when the pedal connected to the <b>DAMPER PEDAL</b> terminal is depressed.	Off, On
Lower1 Pedal	Turning on this setting applies the effect to the split (main) tone when the pedal connected to the <b>DAMPER PEDAL</b> terminal is depressed.	Off, On
Lower2 Pedal	Turning on this setting applies the effect to the split (layer) tone when the pedal connected to the <b>DAMPER PEDAL</b> terminal is depressed.	Off, On
Bend Range	Specifies (in semitone units) how much the pitch of the keyboard performance parts (Port A parts 1 through 5) changes when the pitch bend wheel is rotated all the way upwards or downwards.	00 to 24

## ■ MIXER Screen

Use this screen to change the tone of each part, and to adjust its volume and reverb.

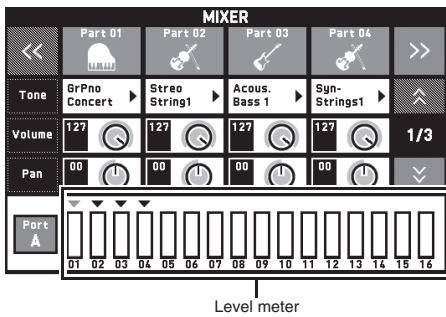





Item	Meaning	Setting
Part	A part that is turned on is sounded. Turn off parts you do not want to sound.	Off, On
Tone	Changes the tone.	650
Volume	Adjusts the volume. The volume level of each part is shown by an on-screen level meter.	0 to 127
Pan	Specifies the stereo pan position of the sound output by the Digital Piano. 0 indicates the center, while a smaller values shifts to the left and a larger value shifts to the right.	-64 to 0 to +63
Coarse Tune	Specifies, in semitone steps, the pitch of the notes of each part.	-24 to 0 to +24
Fine Tune	Specifies, in cent steps, the pitch of the notes of each part.	-99 to 0 to +99
Bend Range	Adjusts, in semitone steps, the bend range of each part.	0 to 24
Reverb Send	Specifies how much reverb is applied to each part. No reverb is applied at all when this setting is 0, while maximum reverb is applied when it is 127.	0 to 127
Chorus Send	Specifies how much chorus is applied to each part. No chorus is applied at all when this setting is 0, while maximum chorus is applied when it is 127.	0 to 127
Delay Send	Specifies how much delay is applied to each part. No delay is applied at all when this setting is 0, while maximum delay is applied when it is 127.	0 to 127
Port	Specifies the port. For information about MIDI channels assigned to each port, see "Part and MIDI Channel Assignments and Diagram" (page A-5).	Port A, Port B, Port C

## ■ MIDI Screen

Use this screen to configure MIDI settings.

For information about MIDI channels assigned to each port, see “Part and MIDI Channel Assignments and Diagram” (page A-5).

MIDI	
Parameter	Setting
Keyboard Channel	01  
Accomp Out	Off
Chord Judge	Off
Hi-Res Vel Out	On
Local Control	On
MIDI Out/Thru	Out  

Item	Description	Setting
Keyboard Channel	Selects the channel for sending keyboard play MIDI data to an external device (keyboard channel).	01 to 16
Accomp Out	Turn on this setting to send MIDI data corresponding to Auto Accompaniment to an external device.	Off, On
Chord Judge	Turning on this setting enables Auto Accompaniment chord input in accordance with the keyboard key press information input in the MIDI channel (any one of ports A, B, or C) specified by the Keyboard Channel from MIDI IN. Just as when chords are input on the Digital Piano keyboard, the chord input keyboard range is for Auto Accompaniment chord input.	Off, On
Hi-Res Vel Out	Turns high-resolution velocity MIDI out on or off.	Off, On
Local Control	Selecting “Off” for Local Control cuts off the Digital Piano’s sound source, so no sound is produced by the Digital Piano when keys are pressed.	Off, On
MIDI Out/Thru	Specifies either Out or Thru as the <b>MIDI OUT</b> terminal function.	Out, Thru
MIDI In Port	Select the port to be used for input from the <b>MIDI In</b> .	A, B, C

## ■ MEDIA Screen

Use this screen to save data to a USB flash drive inserted in the Digital Piano and to import data from a USB flash drive to Digital Piano memory. For more information, see “USB Flash Drive” (page EN-82).

## ■ ARPEGGIATOR Screen

Screen for configuring arpeggiator settings. For details, see “Sounding Arpeggio Phrases Automatically (Arpeggiator)” (page EN-22).



## ■ REGISTRATION Screen

You can specify which current settings should be left unchanged when parameter settings are recalled using the registration function.

REGISTRATION			
Bank		1	
Filter	Setting	Filter	Setting
Split Point	Off	System Setting	Off
Transpose	Off	Controller	Off
Tone	Off	Mixer	Off
Rhythm	Off		
Effect	Off		

Item	Description	Setting
Split Point	Turning on this setting disables recall of the split point setting.	Off, On
Transpose	Turning on this setting disables recall of the transpose setting.	Off, On
Tone	Turning on this setting disables recall of TONE related settings.	Off, On
Rhythm	Turning on this setting disables recall of RHYTHM related settings.	Off, On
Effect	Turning on this setting disables recall of EFFECT related settings.	Off, On
System Setting	Turning on this setting disables recall of SYSTEM SETTING related settings.	Off, On
Controller	Turning on this setting disables recall of CONTROLLER related settings.	Off, On
Mixer	Turning on this setting disables recall of MIXER related settings.	Off, On

- For details about setting items saved by registration, refer to the setting item list in the separate Appendix.

## ■ EQUALIZER Screen

Adjusts the frequency characteristics of all tones.

EQUALIZER				
	Low	Mid1	Mid2	High
Frequency	200Hz ▶	1.0kHz ▶	2.5kHz ▶	10kHz ▶
Gain	00 ◯	00 ◯	00 ◯	00 ◯
Input Level			074	↕
Output Level			127	↕

Item	Description	Setting
Low Frequency	Selects the low-range cutoff frequency.	50, 63, 80, 100, 125, 160, 200, 250, 315, 400, 500, 630, 800 (Hz)
Low Gain	Adjusts the low-range gain.	-12 to 0 to +12
Mid1 Frequency	Selects the low mid-range frequency.	100, 125, 160, 200, 250, 315, 400, 500, 630, 800, 1.0k, 1.3k, 1.6k, 2.0k, 2.5k, 3.2k, 4.0k, 5.0k, 6.3k, 8.0k (Hz)
Mid1 Gain	Adjusts the low mid-range gain.	-12 to 0 to +12
Mid2 Frequency	Selects the middle high-range frequency.	100, 125, 160, 200, 250, 315, 400, 500, 630, 800, 1.0k, 1.3k, 1.6k, 2.0k, 2.5k, 3.2k, 4.0k, 5.0k, 6.3k, 8.0k (Hz)
Mid2 Gain	Adjusts the middle high-range gain.	-12 to 0 to +12
High Frequency	Selects the high-range cutoff frequency.	2.0k, 2.5k, 3.2k, 4.0k, 5.0k, 6.0k, 8.0k, 10k, 13k, 16k (Hz)
High Gain	Adjusts the high-range gain.	-12 to 0 to +12
Input Level	Adjusts the input level.	0 to 127
Output Level	Adjusts the output level.	0 to 127

# USB Flash Drive

Your Digital Piano supports the following USB flash drive operations.

- USB flash drive formatting
- Data storage to a USB flash drive
  - Song data recorded with the Digital Piano's MIDI recorder is stored on a USB flash drive as-is or stored as a MIDI file (SMF format 0).
  - Standard audio data from a computer (WAV files) can also be stored on a USB flash drive and played back on the Digital Piano.
  - Digital Piano play can be recorded directly to a USB flash drive.  
For details, see "Recording to a USB Flash Drive (Audio Recorder)" (page EN-65).
  - Storage of edited Auto Accompaniment data on a USB flash drive
- USB flash drive data loading to Digital Piano memory
  - MIDI files and CASIO format files stored on a USB flash drive can be loaded into the Digital Piano memory (page EN-60).
- Delete data from a USB flash drive
- Easy play back of song data from a USB flash drive

## ■ Types of Data

Data Type	Description (File Name Extension)	Supported Operations	
		Save to USB Flash Drive	Load from USB Flash Drive
User rhythms* (page EN-42)	Auto Accompaniment data edited with this Digital Piano (AC7)	<input type="radio"/>	<input type="radio"/>
User Tones	Tone data edited with this Digital Piano. 1. Melody tones (ZTN) 2. Hex layer tones (ZLT) 3. Drum sound data (ZDR)	<input type="radio"/>	<input type="radio"/>
User MIDI data (pages EN-60, EN-54)	One of the following two types of music data 1. Standard MIDI files (MID) SMF Format 0 or Format 1 2. MIDI data recorded on this Digital Piano (ZMF)	<input type="radio"/>	<input type="radio"/>
User Music Presets (page EN-47)	Music Preset data edited on this Digital Piano (ZMP)	<input type="radio"/>	<input type="radio"/>
Registration (page EN-52)	Tone and rhythm setup settings (ZRM)	<input type="radio"/>	<input type="radio"/>

\* Your Digital Piano also supports import of rhythm data created on another device. Supported file name extensions are: ac7, z00, and ckf.

## USB Flash Drive and USB Flash Drive Port Handling Precautions

### IMPORTANT!

- Be sure to observe the precautions provided in the documentation that comes with the USB flash drive.
- Avoid using a USB flash drive under the following conditions. Such conditions can corrupt data stored on the USB flash drive.
  - Areas subjected to high temperature, high humidity, or corrosive gas
  - Areas subjected to strong electrostatic charge and digital noise
- Never remove the USB flash drive while data is being written to or loaded from it. Doing so can corrupt the data on the USB flash drive and damage the USB flash drive port.
- Never insert anything besides a USB flash drive into the USB flash drive port. Doing so creates the risk of malfunction.
- A USB flash drive can become warm after very long use. This is normal and does not indicate malfunction.
- Static electricity conducted to the USB flash drive port from your hand or from a USB flash drive can cause malfunction of the Digital Piano. If this happens, turn the Digital Piano off and then back on again.

### Copyrights

You are allowed to use recordings for your own personal use. Any reproduction of an audio or music format file, without the permission of its copyright holder, is strictly prohibited under copyright laws and international treaties. Also, making such files available on the Internet or distributing them to third parties, regardless of whether such activities are conducted with or without compensation, is strictly prohibited under copyright laws and international treaties. CASIO COMPUTER CO., LTD. shall not be held in any way liable for any use of this Digital Piano that is illegal under copyright laws.

## Connecting a USB Flash Drive to and Detaching It from the Digital Piano

### IMPORTANT!

- Never plug any other device besides a USB flash drive into the USB flash drive port.
- When you perform a USB flash drive operation or turn on the Digital Piano while a USB flash drive is plugged in, the Digital Piano initially needs to perform a “mounting” sequence to prepare for data exchange with the USB flash drive. Digital Piano operations may be momentarily disabled while a mounting sequence is being performed. While the mounting process is in progress, the message “Media Mounting” will be displayed. It may take up to 10 or 20 seconds or even longer for a USB flash drive to be mounted. Do not attempt to perform any operation on the Digital Piano while a mounting sequence is in progress. A USB flash drive needs to be mounted each time it is connected to the Digital Piano.

### ■ To insert a USB flash drive

1. As shown in the illustration below, insert the USB flash drive into the Digital Piano’s USB flash drive port.
  - Carefully push the USB flash drive in as far as it will go. Do not use undue force when inserting the USB flash drive.

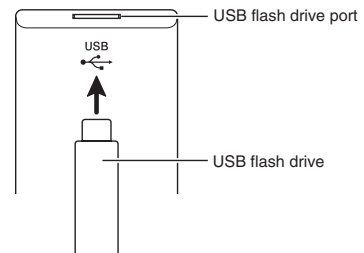

### ■ To remove a USB flash drive

1. Check to confirm that there is no data exchange operation being performed, and then pull the USB flash drive straight out.

## Formatting a USB Flash Drive

### IMPORTANT!

- Be sure to format a USB flash drive on the Digital Piano before using it for the first time.
- Before formatting a USB flash drive, make sure it does not have any valuable data stored on it.
- The format operation performed by this Digital Piano is a “quick format”. If you want to completely delete all of the data in USB flash drive, format it on your computer or some other device.

### Supported USB Flash Drives

This Digital Piano supports USB flash drives formatted to FAT32. If your USB flash drive is formatted to a different file system, use the Windows format function to reformat it to FAT32. Do not use quick format.

1. Insert the USB flash drive to be formatted into the Digital Piano’s USB flash drive port.
2. On the MENU screen, touch “MEDIA”.
3. Touch “FORMAT”.  
This displays a confirmation message (“Sure?”).
4. Touch “Yes”.
  - The message “Please Wait” remains on the display while the operation is being performed. Do not perform any operation while this message is on the display. “Complete” appears on the display after formatting is complete.
  - To cancel the format operation, touch “No”.

## Saving Standard Song Data to a USB Flash Drive

Even when the file format is WAV (general audio data) or SMF (standard MIDI file), the procedure below can be used to save data to USB flash drive and play it back on the Digital Piano.

1. Connect the USB flash drive to your computer.
2. Move the song data file you want to play back to the MUSICDAT folder on the USB flash drive.
  - For information about playback see “To play along with data recorded on a USB flash drive” (page EN-67).

## Saving Digital Piano Data to a USB Flash Drive

Digital Piano memory data (MIDI recorder songs) can be saved to a USB flash drive.

- MIDI Recorder songs can be converted to standard MIDI (SMF) files and stored on the USB flash drive.
- During recording of an Audio Recorder song, the data is stored directly to the USB flash drive, so the operation below is not required.

1. Insert the USB flash drive into the Digital Piano’s USB flash drive port.
2. On the MENU screen, touch “MEDIA”.
3. Touch “Save”.
4. Touch the data type you want to save.
5. Touch the data you want to save.
6. Rename the file as required.
7. After renaming the file, touch “Enter”.

This displays a confirmation message (“Sure?”). If there already a file with the same name on the USB flash drive, a confirmation message (“Replace?”) will appear asking if you want to overwrite it with the new data.

8. Touch “Yes”.
  - The message “Please Wait” remains on the display while the operation is being performed. Do not perform any operation while this message is on the display. “Complete” appears on the display after data save is complete.
  - To cancel the save operation, touch “No”.

## Loading Data from a USB Flash Drive to Digital Piano Memory

You can use the procedure below to load data from a USB flash drive into Digital Piano memory.

### IMPORTANT!

- Place the data (file) you want to load into the MUSICDAT folder on the USB flash drive.
- Insert the USB flash drive into the Digital Piano's USB flash drive port.
  - On the MENU screen, touch "MEDIA".
  - Touch "Load".
  - Touch the data type of the data you want to import.
  - On the "USB" list, touch the data you want to import.
  - On the "User Area" list, touch the import destination you want.
    - If you are importing MIDI data, you will not be able to specify an import destination.
  - Touch "Execute".
 

This displays an import confirmation message ("Sure?"). If there is already data in the import destination in Digital Piano memory, a message ("Replace?") will appear asking if you want to replace it with the new data.
  - Touch "Yes".
    - The message "Please Wait" remains on the display while the operation is being performed. Do not perform any operation while this message is on the display. "Complete" appears on the display after data import is complete.
    - To cancel the import operation, touch "No".

## Deleting Data from a USB Flash Drive

Use the following procedure to delete USB flash drive data (files).

- Insert the USB flash drive into the Digital Piano's USB flash drive port.
- On the MENU screen, touch "MEDIA".
- Touch "Delete".
- Touch the data type of the data you want to delete.
- Touch the data you want to delete.
- Touch "Execute".
 

This displays a delete confirmation message ("Sure?").
- Touch "Yes".
  - The message "Please Wait" remains on the display while the operation is being performed. Do not perform any operation while this message is on the display. "Complete" appears on the display after data delete is complete.
  - To cancel the delete operation, touch "No".

# Connecting to a Computer

You can connect the Digital Piano to a computer and exchange MIDI data between them. You can send play data from the Digital Piano to commercially available music software running on your computer, or you can send MIDI data from your computer to the Digital Piano for playback.

## Minimum Computer System Requirements

The following shows the minimum computer system requirements for sending and receiving MIDI data. Check to make sure that your computer complies with these requirements before connecting the Digital Piano to it.

### ● Operating System

Windows Vista® \*1

Windows® 7 \*2

Windows® 8 \*3

Windows® 8.1 \*4

Mac OS® X (10.6.X, 10.7.X, 10.8.X, 10.9.X, 10.10.X)

\*1: Windows Vista (32-bit)

\*2: Windows 7 (32-bit, 64-bit)

\*3: Windows 8 (32-bit, 64-bit)

\*4: Windows 8.1 (32-bit, 64-bit)

### ● USB port

## ! IMPORTANT!

- Never connect to a computer that does not conform to the above requirements. Doing so can cause problems with your computer.

## NOTE

- For the latest news about supported operating systems, visit the website at the URL below.  
<http://world.casio.com/>

## To connect the Digital Piano to your computer

### ! IMPORTANT!

- Make sure you follow the steps of the procedure below exactly. Connecting incorrectly can make data send and receive impossible.

1. Turn off the Digital Piano and then start up your computer.
  - Do not start up the music software on your computer yet!
2. After starting up your computer, use a commercially available USB cable to connect it to the Digital Piano.

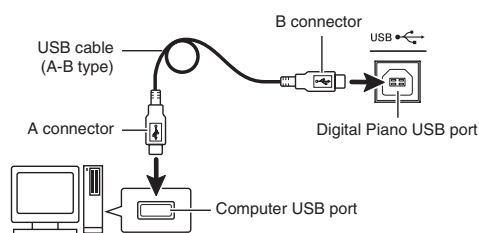

3. Turn on the Digital Piano.
  - If this is the first time you are connecting the Digital Piano to your computer, the driver software required to send and receive data will be installed on your computer automatically.
4. Start up commercially available music software on your computer.
5. Configure the music software settings to select "CASIO USB-MIDI" as the MIDI device.
  - For information about how to select the MIDI device, see the user documentation that comes with the music software you are using.

### ! IMPORTANT!

- Be sure to turn on the Digital Piano first before starting up your computer's music software.

**NOTE**

- Once you are able to connect successfully, there is no problem with leaving the USB cable connected when you turn off your computer and/or Digital Piano.
- This Digital Piano conforms to General MIDI Level 1 (GM).
- For detailed specifications and connections that apply to MIDI data send and receive by this Digital Piano, see the latest support information provided by the website at the following URL.  
<http://world.casio.com/>

## Using MIDI

### What is MIDI?

The letters MIDI stand for Musical Instrument Digital Interface, which is the name of a worldwide standard for digital signals and connectors that makes it possible to exchange musical data between musical instruments and computers (machines) produced by different manufacturers.

For details about the MIDI specifications of this Digital Piano, see the “MIDI Implementation” document at the website located at the URL below.

<http://world.casio.com/>

**NOTE**

- You can alter the Digital Piano’s MIDI setup by changing the MIDI data send channel or other settings. For details, see “MIDI Screen” (page EN-79).
- Use a separately available or commercially available MIDI cable to connect the MIDI terminals of your Digital Piano and another electronic musical instrument for exchange of MIDI data.
- MIDI terminals are disabled while the Digital Piano is connected to a computer via the USB port.



## Error Messages

One of the error messages below appears on the display when a problem occurs.

- To clear an error message and return to the normal display, touch **17 EXIT** on the display.

Display Message	Cause	Action
<b>No Media</b>	<ol style="list-style-type: none"> <li>The USB flash drive is not connected to the Digital Piano's USB flash drive port.</li> <li>The USB flash drive was removed while some operation was in progress.</li> <li>The USB flash drive is write-protected.</li> <li>The USB flash drive has anti-virus software.</li> </ol>	<ol style="list-style-type: none"> <li>Correctly plug the USB flash drive into the USB flash drive port.</li> <li>Do not remove the USB flash drive while any operation is in progress.</li> <li>Unprotect the USB flash drive.</li> <li>Use a USB flash drive that does not have anti-virus software.</li> </ol>
<b>No File</b>	There is no loadable file or no playable file in the "MUSICDAT" folder.	Move the file you want to load or play into the appropriate location (pages EN-84, EN-85) in the "MUSICDAT" folder.
<b>No Data</b>	You are attempting to save user data (user preset, user rhythm, MIDI data, etc.) when there is no data to save.	Select a user data item for which there is data to save.
<b>Read Only</b>	A read-only file with the same name you are trying to use is already stored on USB flash drive.	<ul style="list-style-type: none"> <li>Change the name and then save the new data.</li> <li>Remove the read-only attribute from the existing USB flash drive file and overwrite it with the new data.</li> <li>Use a different USB flash drive.</li> </ul>
<b>Media Full</b>	There is not enough space available on the USB flash drive.	Delete some of the files on the USB flash drive to make room for new data (page EN-85) or use a different USB flash drive.
<b>Too Many Files</b>	<ol style="list-style-type: none"> <li>There are too many files on the USB flash drive.</li> <li>There is a file named TAKE99.WAV in the "MUSICDAT" folder.</li> </ol>	<ol style="list-style-type: none"> <li>Delete some of the files on the USB flash drive to make room for new data.</li> <li>Delete the WAV file in the "MUSICDAT" folder.</li> </ol>
<b>Not SMF01</b>	You are attempting to play back SMF Format 2 song data.	This Digital Piano supports playback of SMF Format 0 or Format 1 only.
<b>Size Over</b>	<ol style="list-style-type: none"> <li>The MIDI recording data on the USB flash drive cannot be played because it is too big.</li> <li>The SMF file on the USB flash drive cannot be played because it is too big.</li> <li>The data you are trying to import cannot be imported because it is too big.</li> </ol>	<ol style="list-style-type: none"> <li>The Digital Piano supports playback of MIDI recording data up to approximately 700KB.</li> <li>The Digital Piano supports playback of SMF files up to 320 KB.</li> <li>The Digital Piano supports import of data (per item) up to the maximum sizes shown below. User Rhythms: Approximately 32 KB User Presets: Approximately 6 KB</li> </ol>
<b>Wrong Data</b>	<ol style="list-style-type: none"> <li>The USB flash drive data is corrupted.</li> <li>USB flash drive contains data that is not supported by this Digital Piano.</li> </ol>	—
<b>Memory Full</b>	<ol style="list-style-type: none"> <li>There is not enough Digital Piano memory available to convert a MIDI recorder song to SMF data and store it on the USB flash drive.</li> <li>There is not enough memory remaining for rhythm editing operations.</li> <li>Remaining memory became too low during music preset editing.</li> </ol>	<ol style="list-style-type: none"> <li>Reduce the size of the song data. Example: Delete any tracks that are not required.</li> <li>Select a different accompaniment pattern.</li> <li>The Digital Piano supports input of approximately 1,000 chords.</li> </ol>
<b>Format Error</b>	<ol style="list-style-type: none"> <li>The USB flash drive format is not compatible with this Digital Piano.</li> <li>The USB flash drive is corrupted.</li> </ol>	<ol style="list-style-type: none"> <li>Format the USB flash drive on the Digital Piano.</li> <li>Use a different USB flash drive.</li> </ol>
<b>Media Error</b>	The USB flash drive is corrupted.	Use a different USB flash drive.
<b>Measure Limit</b>	Attempting to input MIDI recording data or music preset that has more than 999 measures.	The Digital Piano supports input of up to 999 measures.
<b>Data Full</b>	Attempting to store data that exceeds the maximum allowable number of data items.	Delete unneeded data.

## Troubleshooting

Problem	Cause	Action	See Page
<b>No sound is produced when I press a keyboard key.</b>	<ol style="list-style-type: none"> <li>1. The <b>VOLUME</b> controller is set to "MIN".</li> <li>2. Headphones or an adaptor plug is plugged into one of the <b>PHONES</b> jacks.</li> <li>3. Upper 1 icon is off.</li> <li>4. The "Speaker" <b>SYSTEM SETTING</b> is off.</li> </ol>	<ol style="list-style-type: none"> <li>1. Rotate the <b>VOLUME</b> controller more towards "MAX".</li> <li>2. Disconnect whatever is connected to the <b>PHONES</b> jack.</li> <li>3. Touch the Upper 1 icon to turn it on.</li> <li>4. Turn on the "Speaker" <b>SYSTEM SETTING</b>.</li> </ol>	<p>☞ EN-7</p> <p>☞ EN-9</p> <p>☞ EN-15</p> <p>☞ EN-74</p>
<b>The pitch of the Digital Piano is off.</b>	<ol style="list-style-type: none"> <li>1. Digital Piano tuning is incorrect.</li> <li>2. The Digital Piano's key setting is something other than "440.0 Hz".</li> <li>3. A non-standard temperament setting is being used.</li> <li>4. Octave shift is enabled.</li> </ol>	<ol style="list-style-type: none"> <li>1. Adjust Digital Piano tuning, or turn the Digital Piano off and then back on again.</li> <li>2. Change the key setting to "440.0 Hz", or turn Digital Piano power off and then back on again.</li> <li>3. Change the temperament setting to "Equal", which is the standard modern tuning.</li> <li>4. Change the octave shift setting to 0.</li> </ol>	<p>☞ EN-21</p> <p>☞ EN-74</p> <p>☞ EN-74</p> <p>☞ EN-69</p>
<b>Tones and/or effects sound strange. Turning power off and then back on again does not eliminate the problem.</b> <i>Example: Note intensity does not change even though I alter key pressure.</i>	The "Auto Resume" feature is turned on.	Turn off "Auto Resume". Next, turn power off and then back on again.	☞ EN-75
<b>I cannot transfer data after connecting the Digital Piano to a computer.</b>	—	<ol style="list-style-type: none"> <li>1. Check to make sure that the USB cable is connected to the Digital Piano and computer, and that the correct device is selected with your computer's music software.</li> <li>2. Turn off the Digital Piano and then exit the music software on your computer. Next, turn the Digital Piano back on and then restart the music software on your computer.</li> </ol>	☞ EN-86
<b>I cannot record chord accompaniment data on my computer.</b>	"Accomp Out" is turned off.	Turn on "Accomp Out".	☞ EN-79
<b>I cannot store data to a USB flash drive or load data from a USB flash drive.</b>	—	See "Error Messages".	☞ EN-88
<b>Playback stops part way through while transferring song data from my computer.</b>	Digital noise from the USB cable or power cord caused data communication between your computer and Digital Piano to be interrupted.	<p>Stop song playback, disconnect the USB cable from the Digital Piano, and then reconnect it. Next, try playing back the song again.</p> <p>If this does not solve the problem, quit the MIDI software you are using, disconnect the USB cable from the Digital Piano, and then reconnect it. Next, restart the MIDI software and then try playing back the song again.</p>	☞ EN-86
<b>A tone's quality and volume sounds slightly different depending where it is played on the keyboard.</b>	<p>This is an unavoidable result of the digital sampling process,* and does not indicate malfunction.</p> <p>* Multiple digital samples are taken for the low range, middle range, and high range of the original musical instrument. Because of this, there may be a very slight difference in tonal quality and volume between sample ranges.</p>		

Problem	Cause	Action	See Page
<p><b>When I press a button, the note that is sounding cuts out momentarily or there is a slight change in how effects are applied.</b></p>	<p>Performing a button operation while playing with the Duet Mode, Auto Accompaniment, the recorder, or other functions can cause such phenomena when the Digital Piano switches internal tone effects. It does not indicate malfunction.</p>		
<p><b>Even though I play on different ranges of the keyboard, the notes do not change octaves.</b></p>	<p>The ranges of certain tones are limited, which means that octaves change normally up to a certain low note or high note. With such a tone, the notes of the lowest octave will be repeated to the left of the lowest possible note, and the highest octave will be repeated to the right of the highest possible note. This is due do limitations in the range of the original musical instrument for each tone, and does not indicate malfunction of the Digital Piano.</p>		

## Product Specifications

Model	PX-560MBE
Keyboard	88-key piano keyboard <ul style="list-style-type: none"> <li>• Velocity resolution: 16,256 maximum</li> <li>• Layer, Split</li> <li>• Duet: 4 octaves (-2 to 0 to +2)</li> <li>• Transpose: 2 octaves (-12 to 0 to +12)</li> <li>• Octave shift: 4 octaves (-2 to 0 to +2)</li> <li>• Key off velocity</li> </ul>
Sound Source	<ul style="list-style-type: none"> <li>• Number of Tones: 650</li> <li>• Melody Tones: Preset 532/User 280</li> <li>• Hex Layer Tones: Preset 100/User 100</li> <li>• Drum Sounds: Preset 18/User 20</li> <li>• Maximum polyphony: 256 tones</li> <li>• Touch Response (3 sensitivity levels, Off)</li> <li>• Tuning: 415.5 Hz to 440.0 Hz to 465.9 Hz (0.1 Hz units)</li> <li>• Temperament: Equal temperaments plus 16 other types</li> <li>• Stretch Tuning: On, Off</li> </ul>
Display	5.3-inch touch panel (5.0-inch 528 × 320-dot TFT color LCD)
Acoustic Simulator	Linear Morphing, Damper Resonance, Hammer response, String resonance
Effects	Reverb (17 types), Chorus (16 types), Delay (6 types), DSP, 4-band equalizer Editable
Auto Accompaniment	Data items: 220 preset, 30 user
Music Preset	Data items: 305 preset, 100 user
Demo Song	6
MIDI Recorder	<ul style="list-style-type: none"> <li>• Functions: Real-time recording, playback</li> <li>• Number of Song: 100</li> <li>• Number of Tracks: 17</li> <li>• Capacity: Up to approximately 50,000 notes per song</li> <li>• Recorded Data Protection: Built-in flash memory</li> <li>• MIDI Recorder Volume Level: Adjustable</li> </ul>
Audio Recorder	<ul style="list-style-type: none"> <li>• Real-time recording and playback to USB flash drive*               <ul style="list-style-type: none"> <li>* Linear PCM, 16bit, 44.1 kHz, stereo .WAV format</li> </ul> </li> <li>• Songs: 100 files</li> <li>• Approximately 74 minutes maximum recording per file.</li> <li>• Audio Recorder Volume Level: Adjustable</li> </ul>
Registration	96 (4 setups × 24 banks)
Metronome	<ul style="list-style-type: none"> <li>• Beats: 0 to 9</li> <li>• Tempo Range: 20 to 255</li> <li>• Metronome Volume Level: Adjustable</li> </ul>
Pedals	Damper (with half-pedal operation), Soft, Sostenuto, Expression
Other Functions	<ul style="list-style-type: none"> <li>• Dedicated piano tone buttons</li> <li>• Modulation wheel</li> <li>• Arpeggiator</li> <li>• Control knobs</li> <li>• Balance adjustment</li> <li>• Setting backup</li> <li>• Operation Lock</li> </ul>
MIDI	16-channel multi-timbre receive
Pitch Bend Wheel	Pitch Bend Range: 00 to 24 semitones
USB Flash Drive	<ul style="list-style-type: none"> <li>• Capacity: 32GB or less recommended</li> <li>• SMF direct playback, data storage, data loading, USB flash drive format, audio data playback and storage</li> </ul>

Inputs/Outputs	<ul style="list-style-type: none"> <li>• <b>PHONES</b> jacks: Stereo mini jacks × 2</li> <li>• Pedal Jacks: Standard jacks × 2</li> <li>• Power: 12V DC</li> <li>• <b>MIDI OUT/IN</b> terminals</li> <li>• <b>LINE IN R, L/MONO</b> jacks: Standard jacks × 2                  Input impedance: 9.0KΩ                  Input voltage: 200mV</li> <li>• <b>LINE OUT R, L/MONO</b> jacks: Standard jacks × 2                  Output impedance: 2.3KΩ                  Output voltage: 1.8V (RMS) MAX</li> <li>• Audio In: Stereo mini jack                  Input impedance: 9.0KΩ                  Input voltage: 200mV</li> <li>• USB port: Type B</li> <li>• USB flash drive port: Type A</li> <li>• Pedal connector (for optional SP-33 only)</li> </ul>
Speakers	φ 12cm × 2 + φ 5cm × 2 (Output 8W + 8W)
Power Requirements	AC Adaptor: AD-A12150LW • Auto Power Off: Approximately 4 hours after last operation. Auto Power Off can be disabled.
Power Consumption	12V --- 10W
Dimensions	132.2 (W) × 29.3 (D) × 14.7 (H) cm (52 <sup>1</sup> / <sub>16</sub> × 11 <sup>9</sup> / <sub>16</sub> × 5 <sup>13</sup> / <sub>16</sub> inch)
Weight	approximately 12kg (26.5 lbs)

- Specifications and designs are subject to change without notice.

## Operating Precautions

Be sure to read and observe the following operating precautions.

- With a model that has a recording function or other data storage function, be sure to back up any data you want to maintain to another medium before submitting this product for servicing or repair. Stored data may be accessed or even deleted as part of servicing or repair procedures.

### ■ Location

Avoid the following locations for this product.

- Areas exposed to direct sunlight and high humidity
- Areas subjected to temperature extremes
- Near a radio, TV, video deck, or tuner
- The above devices will not cause malfunction of the product, but the product can cause interference in the audio or video of a nearby device.

### ■ User Maintenance

- Never use benzine, alcohol, thinner, or other chemical agents to clean the product.
- To clean the product or its keyboard, wipe with a soft cloth moistened in a weak solution of water and a mild neutral detergent. Wring all excess moisture from the cloth before wiping.

### ■ Included and Optional Accessories

Use only accessories that are specified for use with this product. Use of unauthorized accessories creates the risk of fire, electric shock, and personal injury.

### ■ Weld Lines

Lines may be visible on the exterior of the product. These are “weld lines” that result from the plastic molding process. They are not cracks or scratches.

### ■ Musical Instrument Etiquette

Always be aware of others around you whenever using this product. Be especially careful when playing late at night to keep the volume at levels that do not disturb others. Other steps you can take when playing late at night are closing windows and using headphones.

- Any reproduction of the contents of this manual, either in part or its entirety, is prohibited. Except for your own, personal use, any other use of the contents of this manual without the consent of CASIO is prohibited under copyright laws.
- IN NO EVENT SHALL CASIO BE LIABLE FOR ANY DAMAGES WHATSOEVER (INCLUDING, WITHOUT LIMITATION, DAMAGES FOR LOSS OF PROFITS, BUSINESS INTERRUPTION, LOSS OF INFORMATION) ARISING OUT OF THE USE OF OR INABILITY TO USE THIS MANUAL OR PRODUCT, EVEN IF CASIO HAS BEEN ADVISED OF THE POSSIBILITY OF SUCH DAMAGES.
- The contents of this manual are subject to change without notice.

### ■ AC Adaptor Handling Precautions

- Use a power outlet that is easily accessible so you can unplug the AC adaptor when a malfunction occurs or whenever else you need to do so.
  - The AC adaptor is intended for indoor use only. Do not use it where it might be exposed to splashing or moisture. Do not place any container, such as a flower vase, that contains liquid on the AC adaptor.
  - Store the AC adaptor in a dry place.
  - Use the AC adaptor in an open, well-ventilated area.
  - Never cover the AC adaptor with newspaper, a table cloth, a curtain, or any other similar item.
  - Unplug the AC adaptor from the power outlet if you do not plan to use the Digital Piano for a long time.
  - Never try to repair the AC adaptor or modify it in any way.
  - AC adaptor operating environment  
Temperature: 0 to 40°C  
Humidity: 10% to 90% RH
- Output polarity: 

## AC Adaptor Handling Precautions

### Model: AD-A12150LW

1. Read these instructions.
2. Keep these instructions on hand.
3. Heed all warnings.
4. Follow all instructions.
5. Do not use this product near water.
6. Clean only with a dry cloth.
7. Do not install near radiators, heat registers, stoves, or any other source of heat (including amplifiers).
8. Use only attachments and accessories specified by the manufacturer.
9. Refer all servicing to qualified service personnel. Servicing is required after any of the following occurs: when the product is damaged, when the power supply cord or plug is damaged, when liquid is spilled into the product, when a foreign object falls into the product, when the product is exposed to rain or moisture, when the product does not operate normally, when the product is dropped.
10. Do not allow the product to be exposed to dripping or splashing liquid. Do not place any object containing liquid on the product.
11. Do not allow the electrical load output to exceed the label rating.
12. Make sure the surrounding area is dry before plugging into a power source.
13. Make sure the product is oriented correctly.
14. Unplug the product during lightning storms or when you do not plan to use it for a long time.
15. Do not allow product ventilation openings to become blocked. Install the product in accordance with the manufacturer's instructions.
16. Take care the power cord is located where it will not be stepped upon or bent severely, particularly in locations close to plugs and convenience receptacles, and in locations where it exits from the product.
17. The AC adaptor should be plugged into a power outlet as close to the product as possible to allow immediate disconnection of the plug in case of emergency.

The symbol below is an alert indicating un-insulated hazardous voltage inside the product's enclosure, which may be sufficient to constitute the risk of electric shock to users.



The symbol below is an alert indicating the presence of important operating and maintenance (servicing) instructions in the documentation that accompanies the product.



STLport

Copyright 1994 Hewlett-Packard Company

Copyright 1996,97 Silicon Graphics Computer Systems, Inc.

Copyright 1997 Moscow Center for SPARC Technology.

Permission to use, copy, modify, distribute and sell this software and its documentation for any purpose is hereby granted without fee, provided that the above copyright notice appear in all copies and that both that copyright notice and this permission notice appear in supporting documentation. Hewlett-Packard Company makes no representations about the suitability of this software for any purpose. It is provided "as is" without express or implied warranty.

Permission to use, copy, modify, distribute and sell this software and its documentation for any purpose is hereby granted without fee, provided that the above copyright notice appear in all copies and that both that copyright notice and this permission notice appear in supporting documentation. Silicon Graphics makes no representations about the suitability of this software for any purpose. It is provided "as is" without express or implied warranty.

Permission to use, copy, modify, distribute and sell this software and its documentation for any purpose is hereby granted without fee, provided that the above copyright notice appear in all copies and that both that copyright notice and this permission notice appear in supporting documentation. Moscow Center for SPARC Technology makes no representations about the suitability of this software for any purpose. It is provided "as is" without express or implied warranty.



# Information/Información

## Fingering Guide/Guía de digitación

### Fingered 1, Fingered 2 Chords/Acordes Fingered 1, Fingered 2

<b>C</b>	 	<b>C6</b> *1 *3	
<b>Cm</b>	 	<b>Cm6</b> *2 *3	
<b>Cdim</b>		<b>Cadd9</b>	
<b>Caug</b> *3		<b>Cmadd9</b>	
<b>C♭5</b>		<b>C69</b> *3	
<b>Csus4</b> *3		<b>Cm69</b> *3	
<b>Csus2</b> *3		<b>C7 (♭9)</b>	 
<b>C7</b>	 	<b>C7 (9)</b>	 
<b>Cm7</b> *3	 	<b>C7 (#9)</b>	 
<b>CM7</b>	 	<b>C7 (#11)</b>	
<b>CmM7</b>	 	<b>C7 (♭13)</b>	
<b>Cdim7</b> *3	 	<b>C7 (13)</b>	 
<b>CdimM7</b>		<b>Cm7 (9)</b>	 
<b>C7♭5</b> *3		<b>Cm7 (11)</b> *3	
<b>Cm7♭5</b> *3		<b>CM7 (9)</b>	 
<b>CM7♭5</b>		<b>CmM7 (9)</b>	 
<b>Caug7</b>		<b>C5</b> (Root and 5th only) *4 (La raíz y la 5ta. solamente) *4	
<b>CaugM7</b>		<b>C8</b> (Root only, or root plus octave) *4 (La raíz solamente o la raíz más la octava) *4	
<b>C7sus4</b>			

\*1 With Fingered 2, interpreted as Am7.

\*2 With Fingered 2, interpreted as Am7<sup>♭5</sup>.

\*3 Inverted form not supported in some cases.

\*4 Full Range Chord not supported.

\*1 Con Fingered 2, se interpreta como Am7.

\*2 Con Fingered 2, se interpreta como Am7<sup>♭5</sup>.

\*3 En algunos casos no se puede usar de forma invertida.

\*4 No es compatible con Full Range Chord.

## Fingered 3, Full Range Chords/ Acordes Fingered 3, Full Range

In addition to the chords that can be fingered with Fingered 1 and Fingered 2, the following chords also are recognized.

Además de los acordes que se pueden digitar con Fingered 1 y Fingered 2, también se pueden reconocer los siguientes acordes.

$\frac{C\#}{C}$	$\frac{D}{C}$	$\frac{F}{C}$	$\frac{F\#}{C}$	$\frac{G}{C}$	$\frac{A^b}{C}$	$\frac{A}{C}$	$\frac{B^b}{C}$	$\frac{C\#m}{C}$	$\frac{Dm}{C}$	$\frac{Fm}{C}$
$\frac{F\#m}{C}$	$\frac{Gm}{C}$	$\frac{A^bm}{C}$	$\frac{Am}{C}$	$\frac{B^bm}{C}$	$\frac{Bm}{C}$	$\frac{C\#dim}{C}$	$\frac{Ddim}{C}$			
$\frac{Fdim}{C}$	$\frac{F\#din}{C}$	$\frac{Gdim}{C}$	$\frac{A^bdin}{C}$	$\frac{Adin}{C}$	$\frac{Bdin}{C}$	$\frac{A^b7}{C}$	$\frac{F7}{C}$			
$\frac{Fm7}{C}$	$\frac{FM7}{C}$	$\frac{A^bM7}{C}$	$\frac{F\#m7^b5}{C}$	$\frac{Gm7}{C}$	$\frac{A^badd9}{C}$					

### NOTE

- With Fingered 3, the lowest note fingered is interpreted as the base note. Inverted forms are not supported.
- With Full Range Chord, when the lowest fingered is a certain distance from the neighboring note, the chord is interpreted as a fraction chord.
- Unlike Fingered 1, 2, and 3, Full Range Chord requires pressing of at least three keys to form a chord.

### NOTA

- Con Fingered 3, la nota más baja digitada se interpreta como nota base. No se pueden usar formas invertidas.
- Con Full Range Chord, cuando la nota digitada más baja se encuentre a cierta distancia de la nota adyacente, el acorde se interpreta como un acorde bitonal.
- A diferencia de Fingered 1, 2, y 3, Full Range Chord requiere la pulsación de tres teclas como mínimo para formar un acorde.

Chord Example List/Lista de ejemplos de acordes

Root Chord Type	C	C <sup>#</sup> /(D <sup>b</sup> )	D	(D <sup>#</sup> )/E <sup>b</sup>	E	F	F <sup>#</sup> /(G <sup>b</sup> )	G	(G <sup>#</sup> )/A <sup>b</sup>	A	(A <sup>#</sup> )/B <sup>b</sup>	B
M												
m												
dim												
aug												
♭5												
sus4												
sus2												
7												
m7												
M7												
mM7												
dim7												
dimM7												
7 <sup>♭5</sup>												
m7 <sup>♭5</sup>												
M7 <sup>♭5</sup>												
aug7												
augM7												
7sus4												

Root Chord Type	C	C $\sharp$ /(D $\flat$ )	D	(D $\sharp$ )/E $\flat$	E	F	F $\sharp$ /(G $\flat$ )	G	(G $\sharp$ )/A $\flat$	A	(A $\sharp$ )/B $\flat$	B
6												
m6												
add9												
madd9												
69												
m69												
7 (9)												
7 (9)												
7 (#11)												
7 (b13)												
7 (13)												
m7 (9)												
m7 (11)												
M7 (9)												
mM7 (9)												
5												
8												

- Since the chord input range is limited, this model may not support some of the chords shown above.
- Debido a que el rango de entrada de acordes es limitado, es posible que este modelo no admita algunos de los acordes mostrados arriba.

# Part and MIDI Channel Assignments and Diagram/ Asignaciones de las partes y de los canales MIDI y diagrama

Though this Digital Piano has a sound source that supports simultaneous play of 48 parts, the MIDI standard supports handling of information for up to a maximum of 16 parts. As a result, the 48 parts of the Digital piano are divided among three 16-part ports, resulting in the equivalent of three built-in 16-part MIDI sound sources. The MIDI sound source to which MIDI data that is input into the MIDI IN of the Digital Piano is sent is specified by the setting (Port A, B, or C) of the MIDI In Port setting.

Si bien este piano digital cuenta con una fuente de sonido que permite la ejecución simultánea de 48 partes, el estándar MIDI admite el manejo de información de hasta un máximo de 16 partes. Como resultado, las 48 partes del piano digital se dividen entre tres puertos de 16 partes, lo que resulta en el equivalente de tres fuentes de sonido MIDI incorporadas de 16 partes. La fuente de sonido MIDI a la cual se envían los datos MIDI introducidos en MIDI IN del piano digital se determina mediante la selección (puerto A, B, o C) del ajuste MIDI In Port.

## ■ Port and MIDI Channel Part Assignments/ Asignaciones de las puertas y de las partes de los canales MIDI

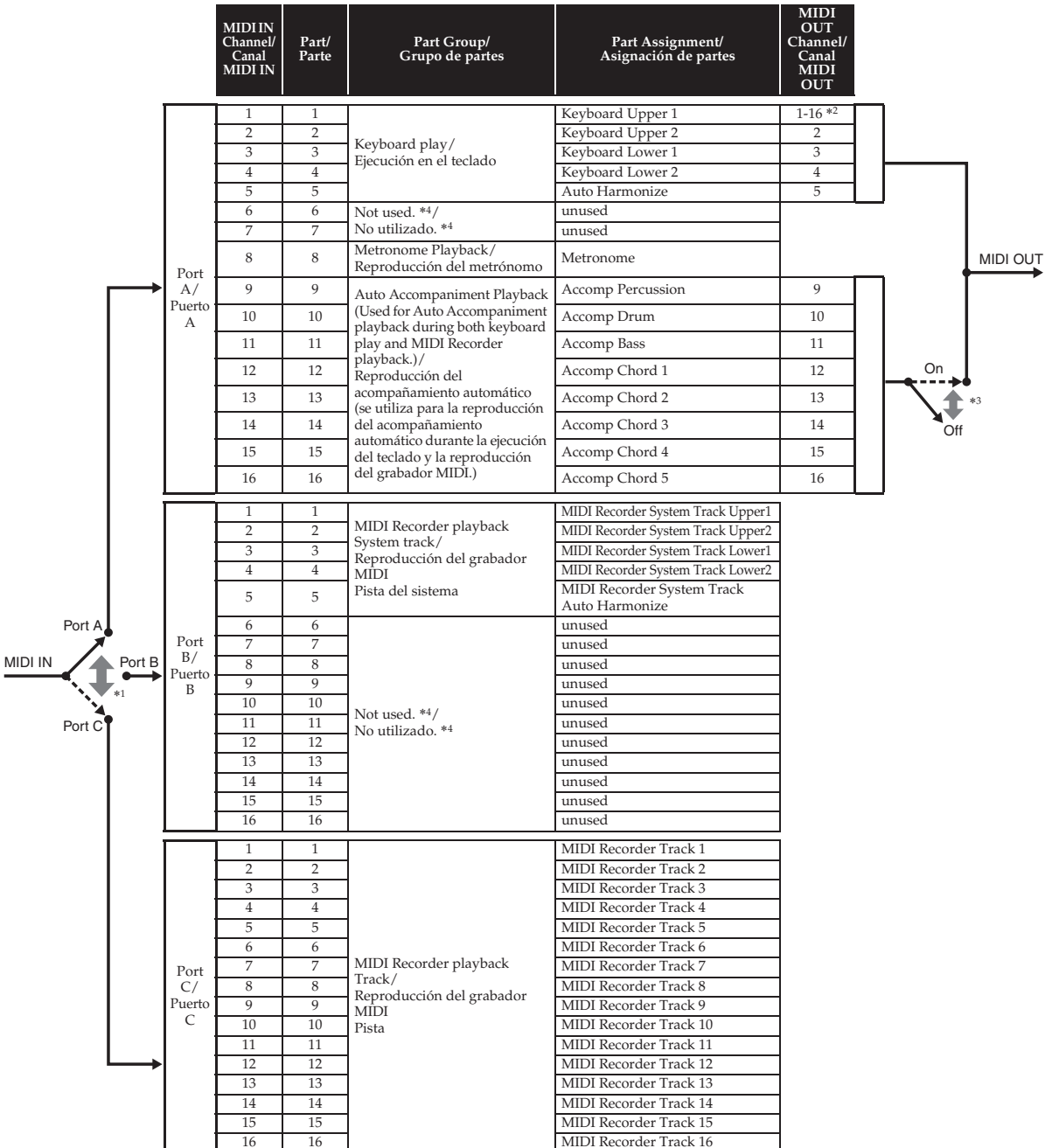

- \*1 The port that accepts MIDI In messages is specified by the "MIDI In Port" setting of the MIDI screen.
- \*2 The MIDI Out channel is specified by the "Keyboard Channel" setting of the MIDI screen.
- \*3 Auto Accompaniment MIDI data settings are configured by the "Accomp Out" setting of the MIDI screen.
- \*4 Use "Not used." parts when inputting performance information from an external source via MIDI In.

- \*1 El puerto que acepta los mensajes MIDI In se determina mediante el ajuste "MIDI In Port" de la pantalla MIDI.
- \*2 El canal MIDI Out se determina mediante el ajuste "Keyboard Channel" de la pantalla MIDI.
- \*3 Los ajustes de los datos MIDI del acompañamiento automático se configuran mediante el ajuste "Accomp Out" de la pantalla MIDI.
- \*4 Utilice las partes "Not used." (No utilizado) cuando se introduce información sobre la ejecución desde una fuente externa a través de MIDI In.

## Block Diagram/Diagrama de bloques

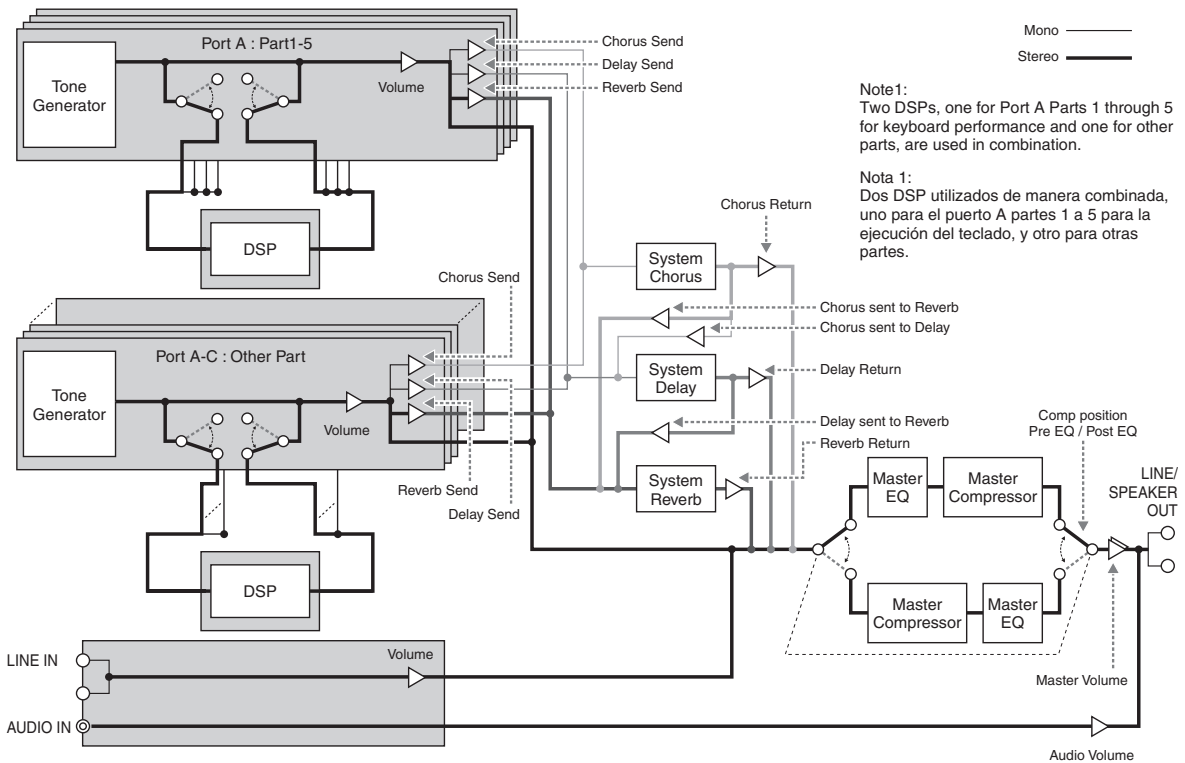

# MIDI Implementation Chart

Function	Transmitted	Recognized	Remarks
<b>Basic Channel</b> Default Changed	1 - 16 1 - 16	1 - 16 1 - 16	
<b>Mode</b> Default Messages Altered	Mode 3 X * * * * * * * * * *	Mode 3 X * * * * * * * * * *	
<b>Note Number</b> True voice	0 - 127 * * * * * * * * * *	0 - 127 0 - 127*1	
<b>Velocity</b> Note ON Note OFF	0 9nH v = 1 - 127 0 8nH v = 0 - 127	0 9nH v = 1 - 127 0 9nH v = 0, 8nH v = 0 - 127	
<b>After Touch</b> Key's Ch's	X X	X O	
<b>Pitch Bender</b>	O	O	
<b>Control Change *2</b>	0 1 5 6, 37 10 11 17 18 19 24 65 66 67 72	0 1 5 6, 37 10 11 17 18 19 24 65 66 67 72	Bank select Modulation Portamento Time Portamento Primary LSB, MSB Volume Pan Expression Expression Expression Parameter1*3 Parameter2*3 DSP Parameter3 DSP Parameter4*3 Portamento Portamento Switch Sostenuto Sustain pedal Sustain Release time







This recycle mark indicates that the packaging conforms to the environmental protection legislation in Germany.

Esta marca de reciclaje indica que el empaquetado se ajusta a la legislación de protección ambiental en Alemania.

**CASIO®**

