

minilogue

POLYPHONIC ANALOGUE SYNTHESIZER

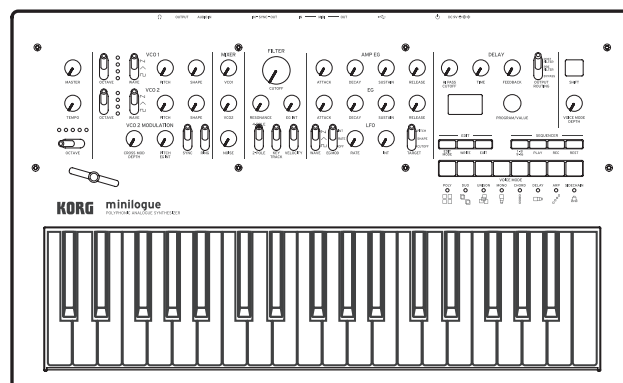

Owner's Manual

Table of contents

Introduction	2	Edit Mode	31
minilogue Key Features	2	How to enter the Edit mode	31
Block Diagram	3	PROGRAM EDIT mode	33
Controls and Connections	4	SEQ EDIT mode	37
Front Panel Controls	4	GLOBAL EDIT mode	40
Rear Panel Connections	5	Other functions	47
Turning the minilogue On and Off	6	Tuning	47
Playing Programs and Sequences	8	Restoring the Factory settings	47
Selecting and Playing a Program	8	Shortcuts using the SHIFT button	49
Using Favorites	9	Understanding MIDI	50
Playing the Sequencer	10	Connecting Devices via MIDI and USB	50
Programs	11	MIDI-Related Settings	52
Program Architecture	11	Program List	54
Creating Sounds	12	Specifications	56
Saving a Program	13	MIDI Implementation Chart	57
Basic Parameter Editing	14		
Voice modes	23		
Sequencer	25		

Introduction

minilogue Key Features

- 4-voice polyphonic synthesizer with onboard effects & sequencer.
- All-new innovative redesign of analogue synth circuitry.
- Instant recall of 100 factory Presets plus 100 additional user Programs.
- 8 Voice Modes (mono, poly, unison, duo, etc.) offer maximum flexibility.
- 41 dedicated panel controls deliver immediate parameter access.
- Real-time oscilloscope provides visual feedback of parameter changes.
- 16-step polyphonic sequencer can automate up to 4 synth parameters.
- Sync In and Sync Out jacks allow you to expand your session setup.

Block Diagram

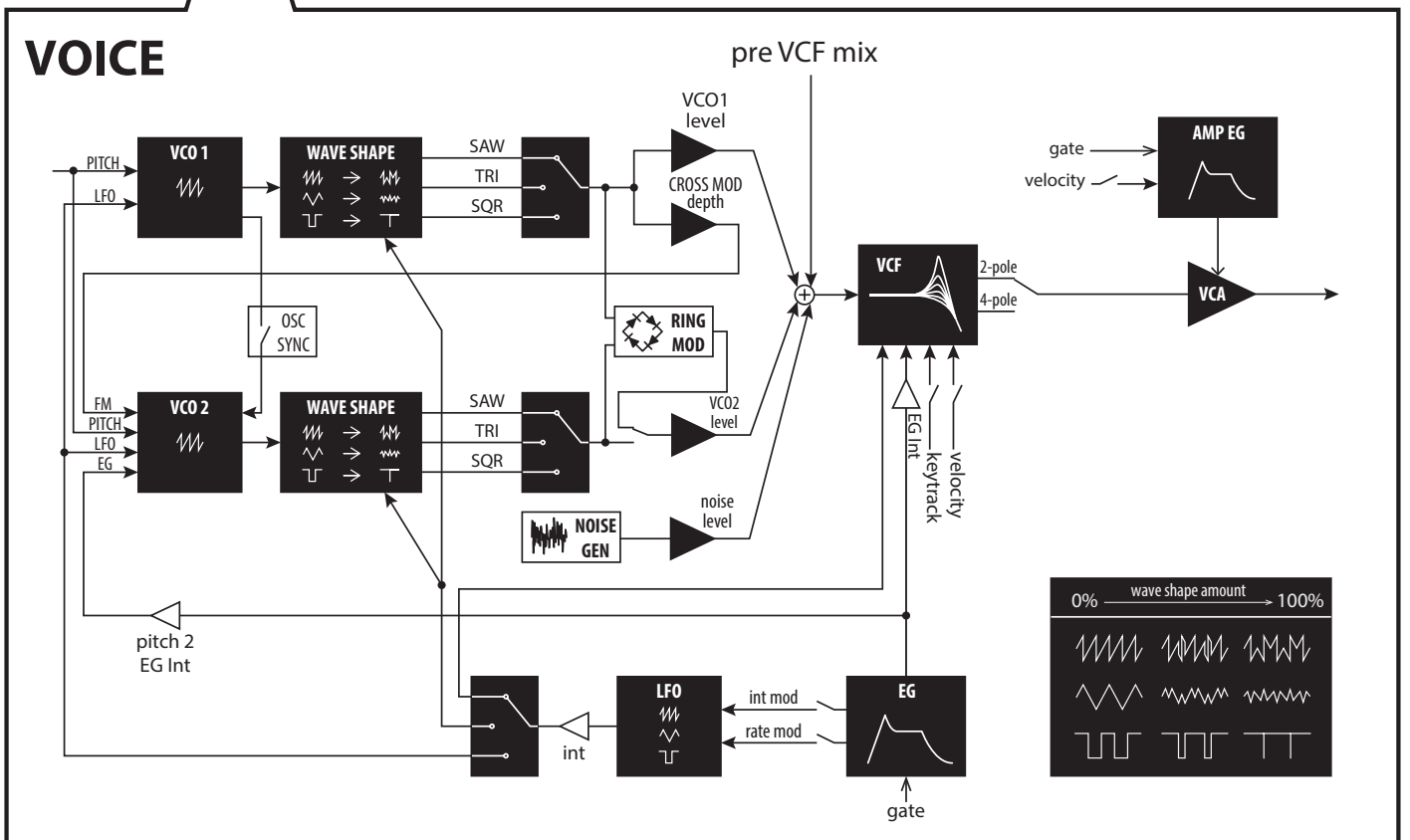
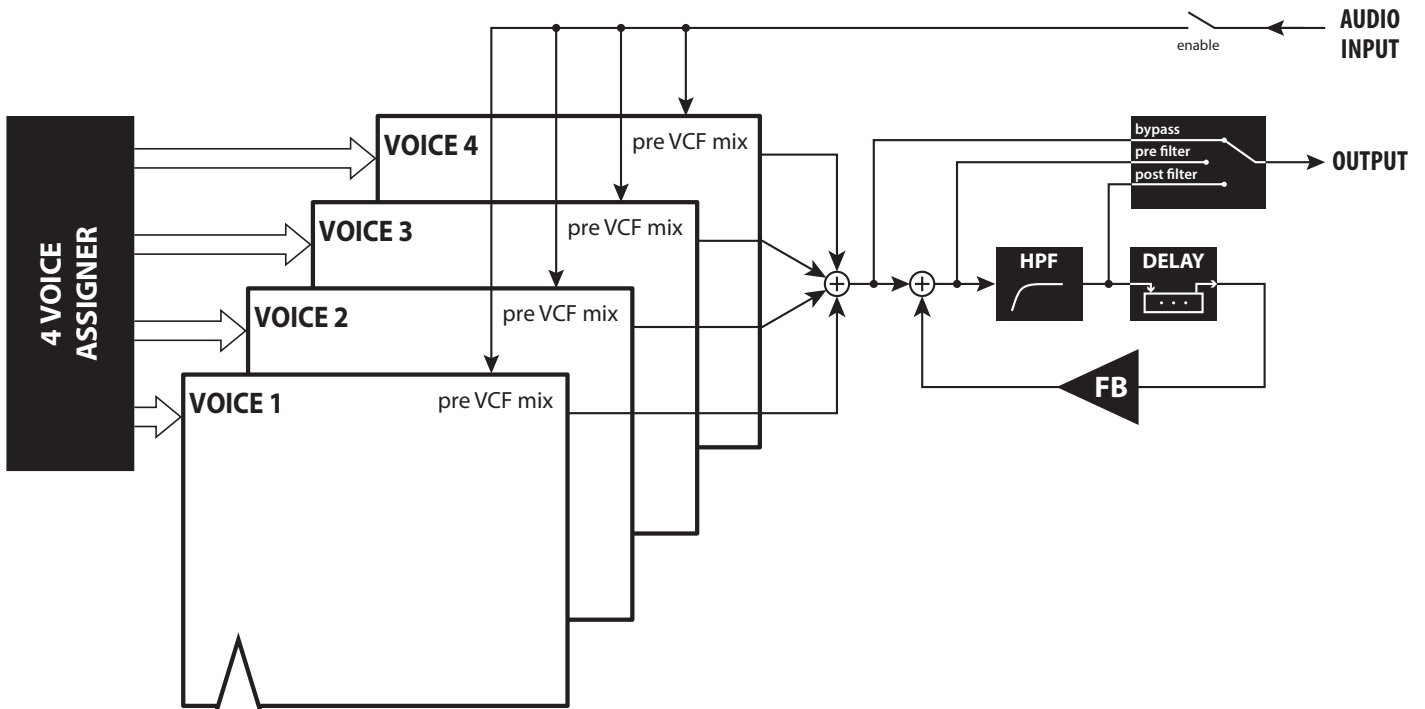

Controls and Connections

Front Panel Controls

This diagram shows the layout of the front panel knobs, switches, and buttons.

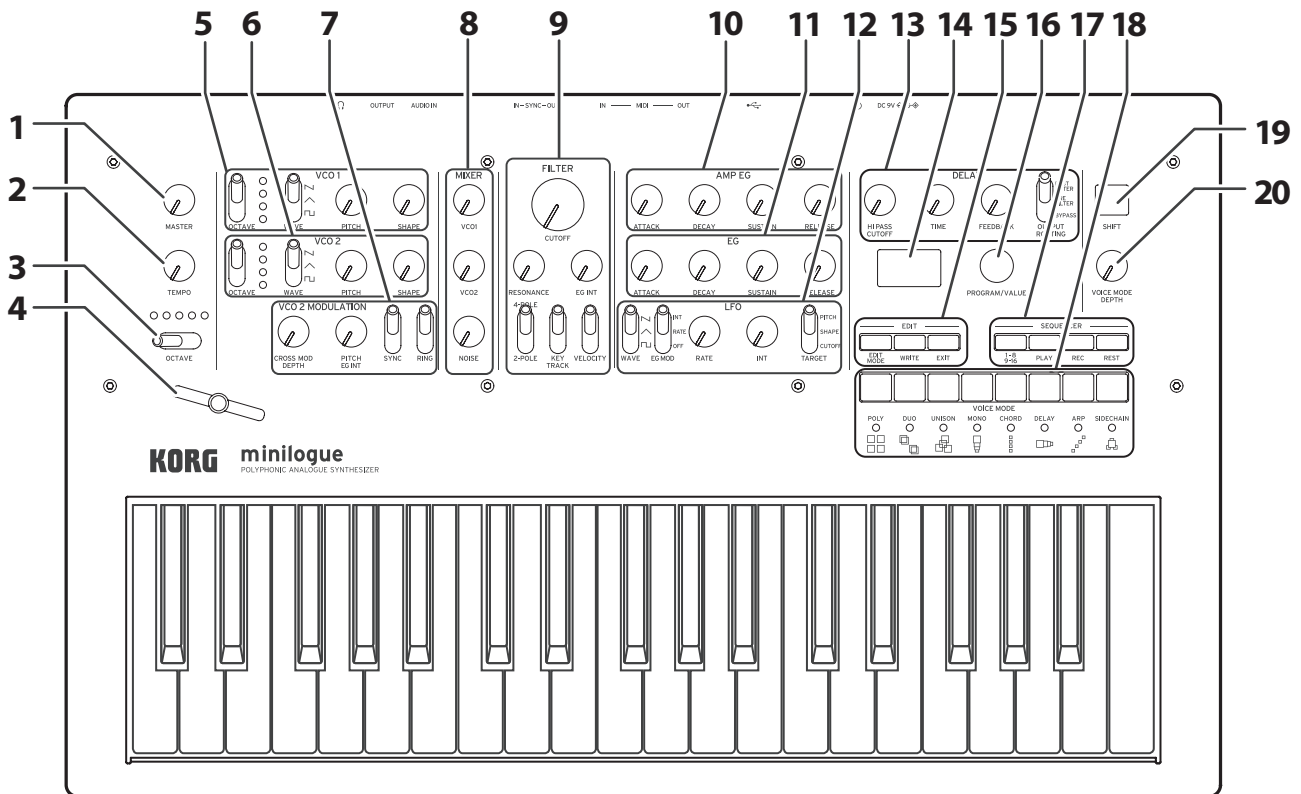

- | | | |
|---|---|---|
| <p>1. MASTER knob</p> <p>2. TEMPO knob</p> <p>3. OCTAVE switch</p> <p>4. Slider</p> <p>5. VCO 1</p> <p>6. VCO 2</p> <p>OCTAVE switch</p> <p>WAVE switch</p> <p>PITCH knob</p> <p>SHAPE knob</p> <p>7. VCO 2 MODULATION</p> <p>CROSS MOD DEPTH knob</p> <p>PITCH EG DEPTH knob</p> <p>SYNC switch</p> <p>RING switch</p> <p>8. MIXER</p> <p>VCO 1 knob</p> <p>VCO 2 knob</p> <p>NOISE knob</p> | <p>9. FILTER</p> <p>CUTOFF knob</p> <p>RESONANCE knob</p> <p>EG INT knob</p> <p>FILTER TYPE switch</p> <p>KEY TRACK switch</p> <p>VELOCITY switch</p> <p>10. AMP EG</p> <p>11. EG</p> <p>ATTACK knob</p> <p>DECAY knob</p> <p>SUSTAIN knob</p> <p>RELEASE knob</p> <p>12. LFO</p> <p>WAVE switch</p> <p>EG MOD switch</p> <p>RATE knob</p> <p>INT knob</p> <p>TARGET switch</p> | <p>13. DELAY</p> <p>HI PASS CUTOFF knob</p> <p>TIME knob</p> <p>FEEDBACK knob</p> <p>OUTPUT ROUTING switch</p> <p>14. Display</p> <p>15. EDIT</p> <p>EDIT MODE button</p> <p>EXIT button</p> <p>WRITE button</p> <p>16. PROGRAM/VALUE knob</p> <p>17. SEQUENCER</p> <p>1-8/9-16 buttons</p> <p>PLAY button</p> <p>REC button</p> <p>REST button</p> <p>18. Buttons 1-8</p> <p>19. SHIFT button</p> <p>20. VOICE MODE DEPTH knob</p> |
|---|---|---|

Rear Panel Connections

The illustration below shows a typical example of connections for the minilogue. Connect your equipment according to the needs of your own system.

SYNC IN, OUT jacks

The minilogue steps can be synchronized with other devices using these jacks. A pulse sent from the audio output of another device or DAW can be used by connecting it to the SYNC IN jack. Use an 1/8" cable (mini-phone plug) to sync with Korg volca products.

MIDI IN, OUT connectors

Connect these to an external MIDI device so that MIDI data can be transmitted or received.

USB B connector

This connector allows the minilogue to exchange MIDI messages with your computer.

Power switch

Hold this switch in to turn the minilogue On or Off.

Cable hook

Loop the DC Plug end of the AC Adapter cable around this hook to prevent the cable from being accidentally pulled out.

AUDIO IN jack

This standard 1/4" TS jack accepts a mono audio signal from another synthesizer, instrument, or external sound source.

OUTPUT jack

This standard 1/4" TS jack sends the sound of the minilogue to your powered monitoring system, mixer, recording setup, or external amplifier. The level is controlled by the MASTER knob.

Headphones jack

Connect your headphones here. This jack outputs the same sound as the OUTPUT jack.

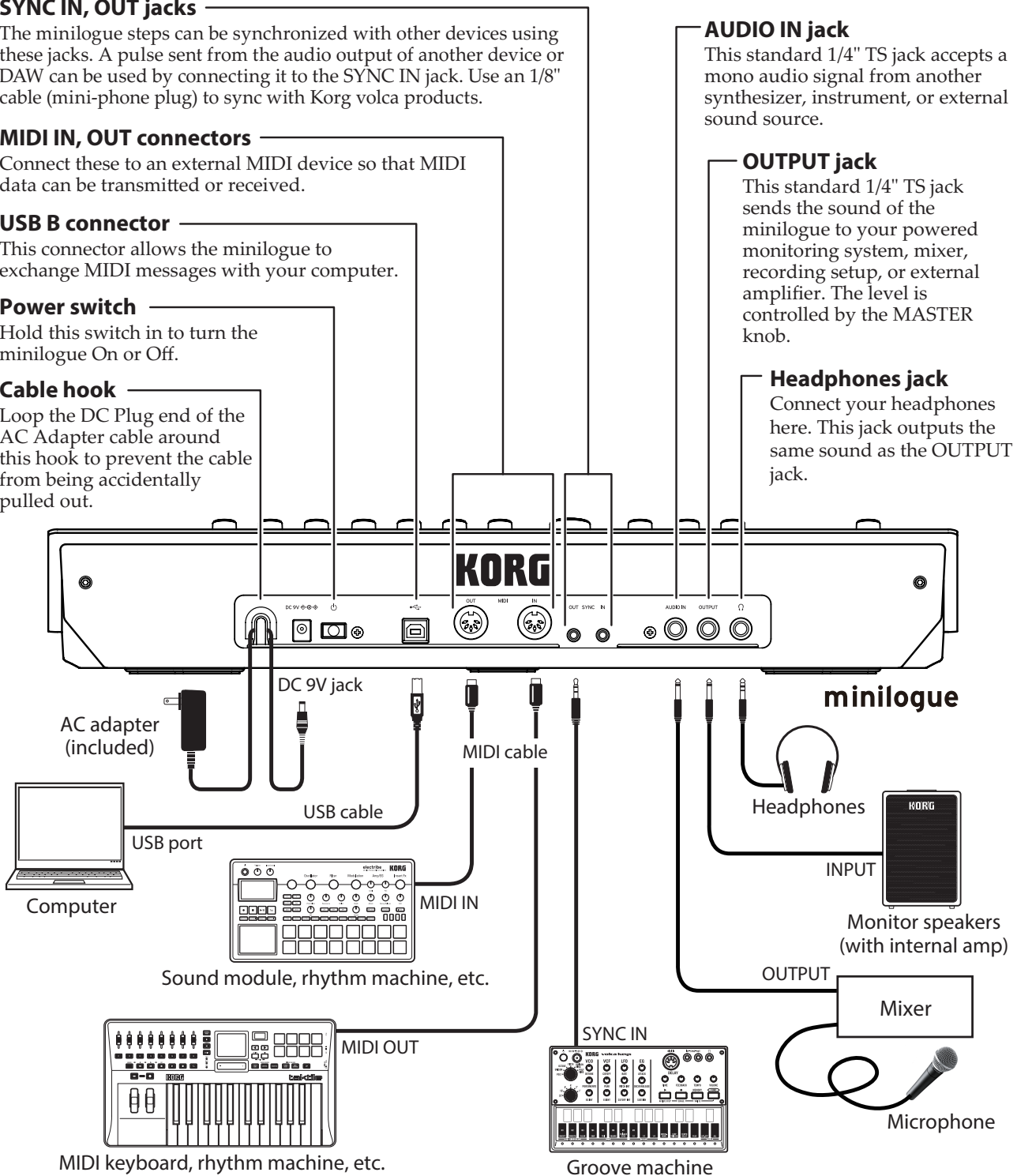

⚠ You must make connections with the minilogue turned off. Failure to observe this precaution may cause malfunctions and/or damage to your speaker system.

Turning the minilogue On and Off

Before you turn the minilogue On:

Connect the AC adapter and other equipment.

1. **Connect the included AC adapter to the DC 9V jack located on the rear panel.**

 Use only the included AC adapter. Using any other AC adapter may cause malfunctions.

2. **Plug the AC adapter into an AC outlet.**

3. **Hook the AC adapter cable onto the cable hook to relieve stress on the connector and to prevent the cable from accidentally being pulled out.**

When disconnecting the power supply, do not use excessive force when removing the cable from the hook. Doing so may damage the plug.

4. **Make sure that any external output devices such as powered monitor speakers are turned off before connecting them to the minilogue.**

TIP If you want to connect a MIDI device or computer to the minilogue's MIDI connectors or USB B connector in order to use the minilogue's keyboard and controllers to control an external MIDI tone generator, or if you want to use another MIDI keyboard or a sequencer to play the minilogue's sound generator, you will need to configure the settings. For details, ("Understanding MIDI", p. 50).

Turning the minilogue On

1. **Make sure that both the minilogue and any external output devices such as powered monitor speakers are turned off, and turn the volume of all devices all the way down.**
2. **Hold down the Power switch on the rear panel of the minilogue; once the "minilogue" logo appears in the display, take your finger off the Power switch.**
3. **Turn on any external output devices such as powered monitor speakers.**
4. **Adjust the volume of your external output equipment, and adjust the minilogue's volume using the MASTER knob.**

Turning the minilogue Off

Any Program data in the minilogue that has not been saved will be lost when the power is turned off. Be sure to save any Program and other important data that you have edited (“Saving a Program”, p. 13).

1. Turn the MASTER knob of the minilogue to the left to turn the volume all the way down.

Also, turn the volume all the way down on any external output devices that might be connected, such as powered monitor speakers.

2. Hold down the Power switch on the rear panel of the minilogue; to turn off the power after the display goes blank, take your finger off the power switch.

⚠ Once you have turned the minilogue off, wait about 10 seconds before turning the minilogue on again.

Auto Power Off Feature

The minilogue features an Auto Power Off feature that can automatically turn the minilogue off after 4 hours have elapsed with no operation of the knobs, switches, buttons, or keyboard of the minilogue. By default, the factory setting for the Auto Power Off is enabled. The Auto Power Off can be disabled using the steps below.

1. Press the EDIT MODE button.

The minilogue will enter the Edit Mode, and the display will look like the illustration shown below.

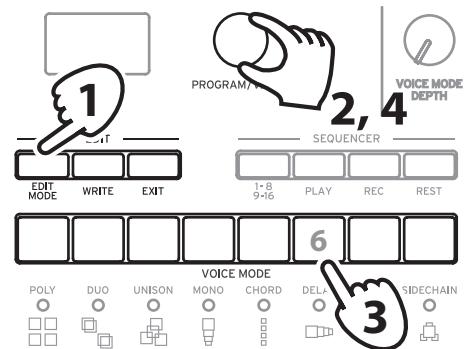

2. Turn the PROGRAM/VALUE knob, and select GLOBAL EDIT.

TIP GLOBAL EDIT can also be selected by pressing the EDIT MODE button.

3. Press button 6 twice.

“Auto Power Off” will be displayed.

4. Turn the PROGRAM/VALUE knob, and select “Off”.

5. Press the EXIT button.

The minilogue will enter the Play mode, and the display will indicate the current Program.

Playing Programs and Sequences

Selecting and Playing a Program

The minilogue comes equipped with 200 Programs. Of those, 100 are ready-to-play preset Programs and 100 locations are available to save your own sounds and custom edits.

Each Program includes settings for the sound, as well as sequence data and Voice mode settings.

1. Enter the Play mode.

When the minilogue is turned on, it will automatically enter the Play mode. In the Play mode, verify that all of the EDIT MODE and 1–8/9–16 buttons on the front panel are unlit.

TIP If the EDIT MODE button or the 1–8/9–16 button is lit, press the EXIT button. The PLAY or REC buttons will light to indicate when the sequence data saved in a Program is being played back or is recording. You can still select other Programs in this state, but press the PLAY button if you wish to stop the Sequencer.

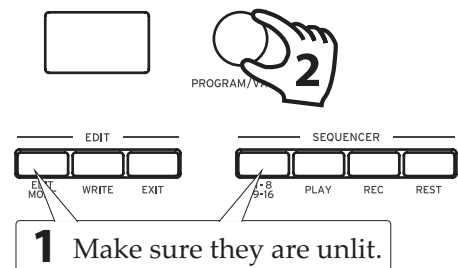

2. Turn the PROGRAM/VALUE knob to select a Program.

The display will indicate the Program name and number.



The minilogue comes with 100 preset Programs (001–100) as part of the factory preload data. These preset Programs are instantly accessible and ready for you to enjoy. For details, refer to “Program List” (p. 54).

TIP Hold down the SHIFT button while turning the PROGRAM/VALUE knob to skip through the Program List in increments of 10.

TIP In addition to showing Program name and number, the display can also be used as an **oscilloscope**, to show the electrical signals created by the waveform of the sound. For details on the display, refer to “Oscilloscope” (p. 45).

3. Adjusting the OCTAVE range, using the Slider, and changing the Voice Mode.

As you play, you can use the five-way OCTAVE Switch to transpose the playing area of the keyboard by ± 2 octaves.

In addition, you can move the Slider from left to right to add real-time performance control.

TIP The parameter assigned to the slider will vary depending on the Program. Refer to “Program List” (p. 54) to see which parameter is assigned to the slider in each Program.

TIP The Slider Assign function in PROGRAM EDIT mode is used to assign parameters to the slider (“Slider Assign”, p. 33).

In the Play mode, the LEDs below buttons 1–8 show the Voice mode status of the current Program. You can use these buttons 1–8 to switch between the different modes. For details, refer to “Voice modes” (p. 23).

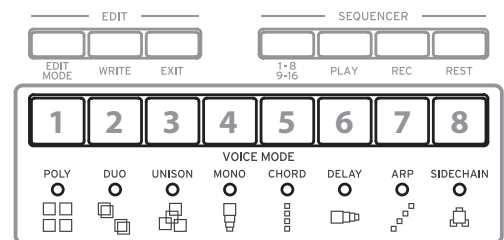
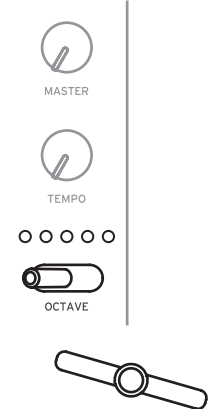

Using Favorites

Recalling your Favorite Programs

The minilogue includes a **Favorites function**, which can be used to instantly recall any one of the up to eight Programs that you have previously registered as Favorites on the minilogue.

1. In the Play mode, press one of the buttons from 1–8 while holding down the **SHIFT** button.

The Favorite Program previously registered to that button will be recalled, and the Program name and number will be indicated in the display.

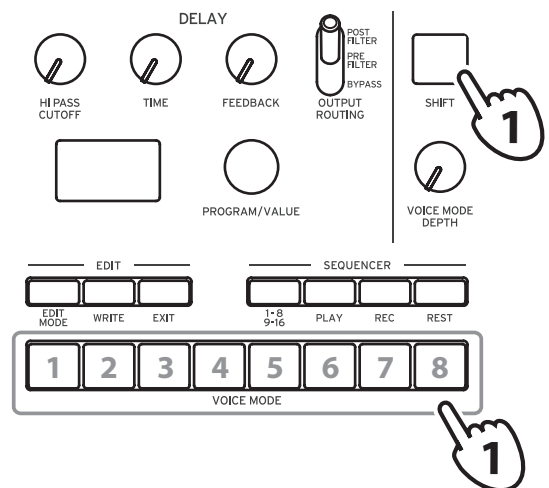

Registering your Favorite Programs

You can register up to eight Programs that you particularly like as Favorite Programs.

1. In Play mode, turn the PROGRAM/VALUE knob to select a Program you like.

The display will indicate the Program name and number.

2. Hold down one of the buttons from 1–8 while keeping the SHIFT button pressed.

The Program will be registered as a Favorite program, and “Registered to Favorite” will be indicated in the display.

TIP The favorite Programs that you register will be saved in the Global settings.

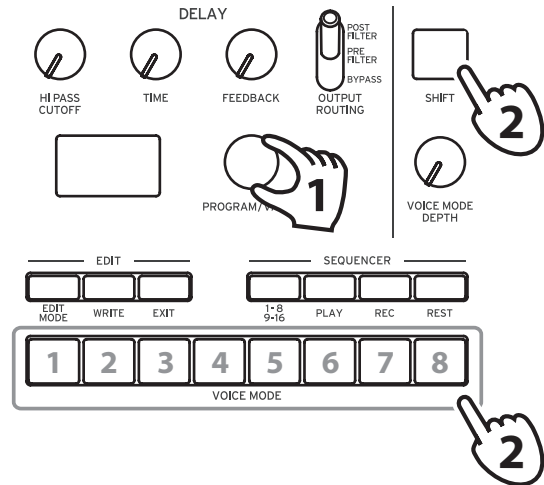

Playing the Sequencer

Each Program in the minilogue includes sequence data. In this section, we'll play the sequence data saved as part of the preset Programs.

1. Turn the PROGRAM/VALUE knob to select a Program.

The display will indicate the Program name and number.

2. Press the PLAY button in the SEQUENCER section.

The sequence data that is recorded in the current Program will begin playing.

The 1–8 buttons will light up in steps while the sequencer is playing.

TIP The Sequencer tempo is set for each Program in the SEQ EDIT mode and saved as part of the Program, but you can adjust the tempo from 56.0 to 240.0 BPM (Beats Per Minute) by turning the TEMPO knob.

3. Press the PLAY button once more to end the Sequencer playback.

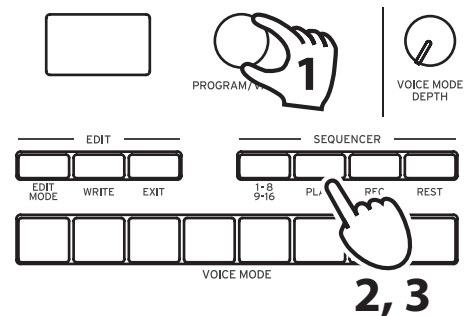

Programs

Program Architecture

Each minilogue Program includes settings for the Oscillators, Mixer, Filter, EGs and LFO, as well as a 16-Step Sequencer plus Effects.

Try editing each related parameter, and enjoy changing the sounds of the minilogue.

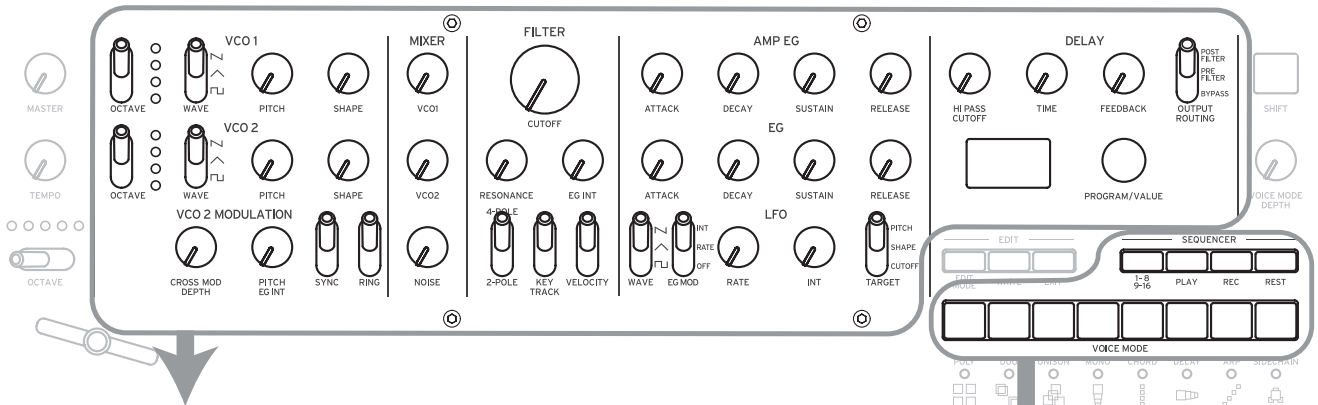

Basic Parametres

VCO 1 OCTAVE WAVE PITCH SHAPE	MIXER VCO1 VCO2 NOISE	EG ATTACK DECAY SUSTAIN RELEASE
VCO 2 OCTAVE WAVE PITCH SHAPE	FILTER CUTOFF RESONANCE EG INT FILTER TYPE KEYTRACK VELOCITY	LFO WAVE EG MOD RATE INT TARGET
VCO 2 MODULATION CROSS MOD DEPTH PITCH EG INT SYNC RING	AMP EG ATTACK DECAY SUSTAIN RELEASE	DELAY HI PASS CUTOFF TIME FEEDBACK OUTPUTROUTING

Detail Parametres

PROGRAM NAME Slider Assign Bend Range + Bend Range -	LFO BPM Sync LFO Key Sync LFO Voice Sync	Portamento Time Portamento Mode Portamento BPM Amp Velocity Program Level
---	--	---

Sequence Data

NOTE [STEP 1-16]
 GATE TIME [STEP 1-16]

STEP	1	2	3	...	14	15	16
NOTE	♪	♪	♪	...	♪	♪	♪
GATE							

Sequence Parameters

BPM

Step Length
 Step Resolution
 Swing
 Default Gate Time

Motion Type (1-4)
 Motion Enable (1-4)
 Motion Smooth (1-4)

Creating Sounds

Editing a program means changing the Program's parameters to alter its sound.

There are two way to create sounds on the minilogue.

- Select an existing Program that's close to the sound you want, and edit that Program's parameters to achieve your own custom sound.
- You can also initialize all the Program parameters or use the Panel Load function to create your own sound from scratch.

Editing an Existing Program

1. **In Program mode, select the Program that you want to use as a starting point.**
2. **Use the knobs and switches on the front panel.**

Take a moment to consider the differences between the current Program and the sound you have in mind, and use the front panel controls to edit the necessary parameters.

TIP For details on how the pitch, sound, and volume change when using the knobs and switches, refer to "Basic Parameter Editing" (p. 14).

 We recommend that you save the Program on the minilogue after editing the sound. Any edits that you make will be lost if you turn off the power or recall a different Program. For details, refer to "Saving a Program" (p. 13).

Creating a Program from Scratch

To create a sound from scratch, we recommend that you use the **Panel Load function**. This will load the current settings of each front panel control and provide a simple starting point for your iconic creations.

As you explore the front panel controls, you can see how each parameter will affect the sound, making it easier to understand how each section of the minilogue functions and how the parameters interact.

Panel Load function

Press the PLAY button while holding down the SHIFT button. The sound will change to reflect the panel settings, and "Load Panel" will be indicated in the display.

Saving a Program

We recommend that you save your Program on the minilogue after editing the sound.

⚠ Any edits that you make to the current program will be lost if you turn off the power or recall a different program before saving.

1. Edit the program in Play mode.

For details, refer to “Basic Parameter Editing” (p. 14).

2. Press the WRITE button; the minilogue will enter the Write standby mode, and the WRITE button will blink.

The message “Where to write?” will appear in the display.

3. Turn the PROGRAM/VALUE knob to select the Program number where your new sound will be saved.

Programs 1–100 are preset Programs, and Programs 101–200 are user Programs.

TIP Press the EXIT button to cancel the operation.

4. Press the WRITE button once more.

The Program will be saved in internal memory, and the message “Complete” will appear in the display..

⚠ Never turn off the power while Programs are being saved. Doing so may destroy the internal data.

Basic Parameter Editing

In this section, we'll explain the basic parameters that make up a program. The basic parameters are assigned to the knobs and switches on the front panel.

VCO 1, VCO 2

VCO: Voltage Controlled Oscillator

There are two oscillators in the minilogue. Oscillator Parameters include the settings for the pitch of the sound (OCTAVE, PITCH) and the waveform (WAVE, SHAPE).

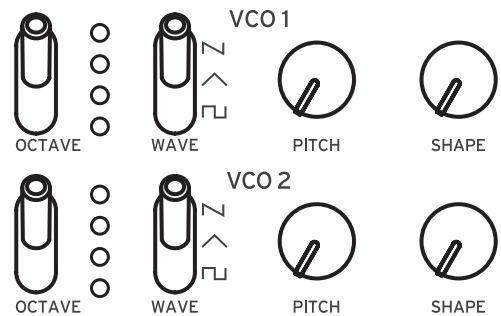

OCTAVE switch [16', 8', 4', 2']

The pitch of oscillators 1 and 2 can be set in octave steps.

WAVE switch [□, ▲, ▽]

This sets the waveforms for oscillators 1 and 2.

Square wave: This waveform is used for electronic and wind instrument sounds.

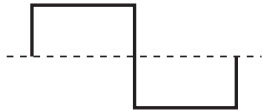

Triangle wave: This waveform has a rounder feel than the sawtooth or square wave.

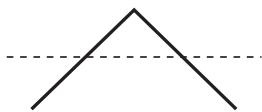

Sawtooth wave: This waveform is used to create sounds typical of analog synthesizers, such as synth basses and brass.

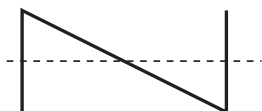

PITCH knob **[-1200...+1200]**

The pitch, or tuning, of the Oscillators can be set using one-cent steps.

SHAPE knob **[0...1023]**

This knob will determine the final shape, complexity, or duty-cycle (Square) of the selected waveform.

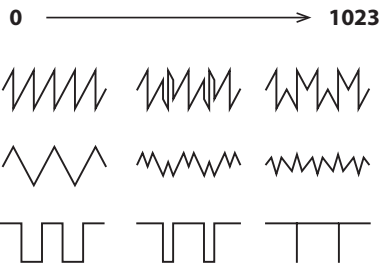

VCO 2 MODULATION

Oscillator 2 includes powerful oscillator sync, cross modulation, and ring modulation functions.

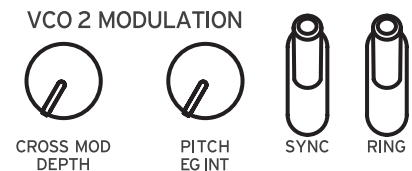

CROSS MOD DEPTH knob **[0...1023]**

Cross Mod (Modulation) allows Oscillator 1 to modulate the pitch of Oscillator 2.

Turning the knob to the right results in stronger modulation.

PITCH EG DEPTH knob **[-4800...+4800]**

The Pitch EG (Envelope Generator) can be used to change the Pitch of Oscillator 2 over time. In the center position, no effect is applied.

Positive values (turning the knob to the right of center) increase the Pitch EG effect; turning the knob to the left of center increases the Pitch EG effect using an inverted image of the EG shape (negative values).

To learn more about the EG settings, refer to “EG” (p. 20).

SYNC switch [OFF, ON]

Oscillator sync is a popular effects for creating edgy synth leads.

ON (up position): With this type of modulation, the phase of oscillator 2 is forcibly synchronized to the phase of oscillator 1. This adds harmonic overtones to the frequency of oscillator 2, making a complex waveform.

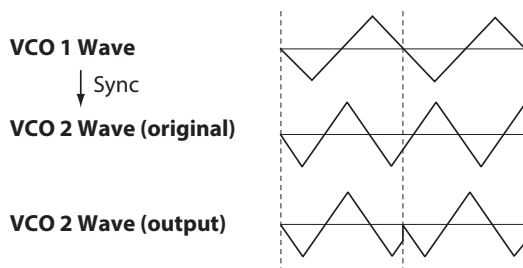

RING switch [OFF, ON]

Ring Modulation outputs the sum and difference of the frequencies created by the two oscillators. Adjust the pitch of Oscillator 2 to create non-tonal and metallic sounds.

ON (up position): Oscillator 1 is used to ring modulate oscillator 2.

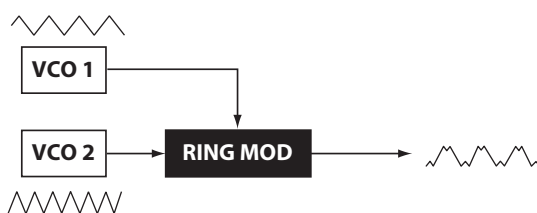

MIXER

The mixer is used to set the relative levels of the three signal sources—Oscillator 1, Oscillator 2, and the Noise generator before they enter the filter.



VCO 1 knob [0...1023]

VCO 2 knob [0...1023]

These knobs control the output levels of oscillator 1 and 2.



NOISE knob [0...1023]

Use this knob to set the output level of the noise generator.

Noise (white noise) can be used on its own, or mixed with the Oscillators to create percussion instrument sounds, or sound effects such as surf.



FILTER

VCF: Voltage Controlled Filter

The low-pass filter shapes the tone by selectively filtering certain parts of the harmonic spectrum of the sound generated by the Oscillators and the Noise generator.

CUTOFF knob [0...1023]

This knob is used to set the cutoff frequency. Harmonic content above the cutoff frequency will be filtered out.

Turning the knob to the left will lower the cutoff frequency, and turning the knob to the right will raise the cutoff frequency.

- ⚠ If the CUTOFF value is set too low, the volume may be extremely low.

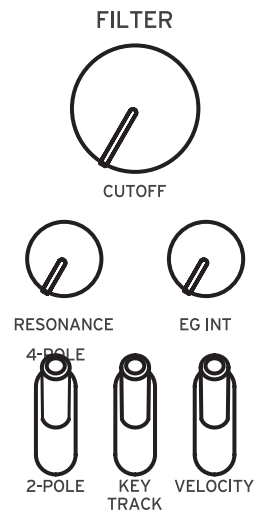

RESONANCE knob [0...1023]

Also known as Peak or Q, the RESONANCE control adds additional emphasis to the overtones occurring at the CUTOFF frequency, giving a distinctive character to the sound.

Turning the knob to the right will increase the resonance effect.

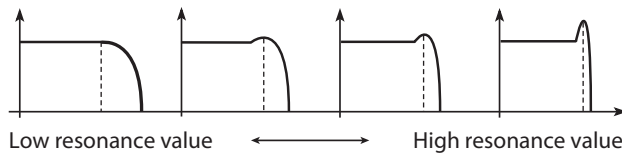

- TIP** The overtones that are emphasized will change depending on the cutoff frequency. For this reason, it's good to adjust the CUTOFF knob while adjusting the RESONANCE knob.

- ⚠ When emphasizing the overtones in this way, the sound may distort depending on the cutoff frequency or the input audio.

EG INT knob **[-100%...0...+100%]**

The Envelope Generator (EG) can be used to control the CUTOFF, or Filter frequency, over time using this EG INT (intensity) knob.

To learn more about the EG settings ("EG", p. 20).

With this knob in the center position (0%), no EG is applied to the Filter.

Rotating the knob to the left of center increases the EG intensity, but with the polarity of the EG inverted.

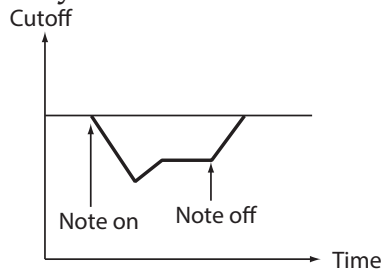

Rotating the knob to the right of center increases the EG intensity effect.

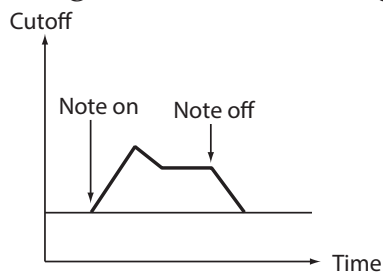

FILTER TYPE switch **[2-POLE, 4-POLE]**

The filter type (roll off) can be set to either 2-POLE (12 dB per octave) or 4-POLE (24 dB per octave).

2-POLE: Gently cuts off the upper harmonics, creating a more natural sound.

4-POLE: Cuts off the upper harmonics more sharply than the 2-POLE.

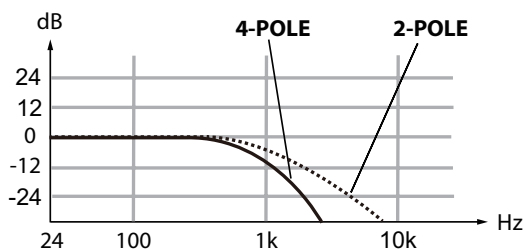

KEY TRACK switch **[0%, 50%, 100%]**

Key tracking allows the note played on the keyboard to influence the cutoff frequency of the filter. This is useful when you want higher notes to have more upper harmonics, or to appear brighter, than lower notes.

0% (lower position): No keyboard tracking will be applied.

50% (center position): The cutoff frequency will change at half the rate/slope as the pitch of the keyboard.

100% (upper position): The cutoff frequency will change at the same rate/slope as the pitch of the keyboard.

VELOCITY switch [0%, 50%, 100%]

Specifies how the velocity (keyboard playing dynamics) will affect the cutoff frequency, allowing louder notes to appear brighter, etc.

0% (lower position): Velocity will not affect the cutoff frequency.

50% (center position): Velocity will affect the cutoff frequency, but at only half the amount produced at 100%.

100% (upper position): Playing the keys harder will increase the cutoff frequency, while playing the keys softer will decrease the cutoff frequency.

AMP EG

VCA: Voltage Controlled Amplifier / EG: Envelope Generator

The AMP (VCA) controls the output level of the minilogue, before the Master control. The AMP Envelope Generator provides a precise control signal that varies over time to modify the VCA level.

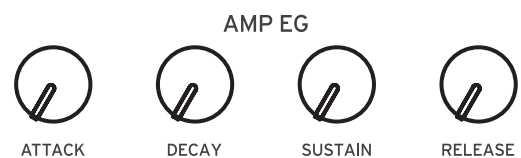

ATTACK knob [0...1023]

The ATTACK specifies the time required for the EG to reach its maximum level once a new note is played

DECAY knob [0...1023]

The DECAY specifies the time required for the EG to fall to the preset Sustain level once the Attack portion of the EG is complete.

SUSTAIN knob [0...1023]

The SUSTAIN specifies the level that will be maintained while the key is held down (or a trigger is applied).

RELEASE knob [0...1023]

The RELEASE specifies the time required for the EG to reach its minimum level (zero) once the key or trigger is released.

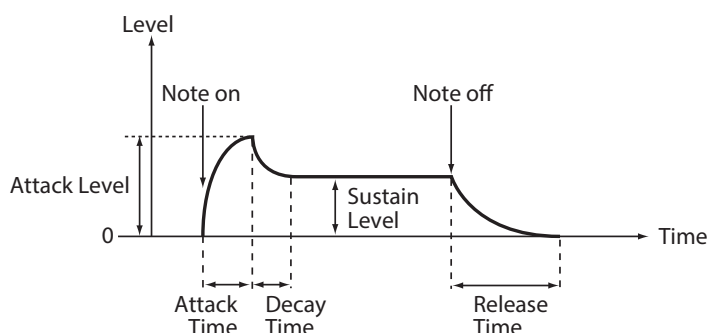

EG

EG: Envelope Generator

The EG provides a precise control signal that varies over time. This signal can be used to modify the Pitch of Oscillator 2, the Filter CUTOFF frequency, and the Speed or Intensity of the LFO. The EG signal is available at the VCO 2 MODULATION PITCH EG INT knob, the FILTER EG INT knob, and the LFO EG MOD switch. This switch can be set to allow the EG signal to control either the RATE or INT (Intensity), in conjunction with the LFO RATE and INT knobs.

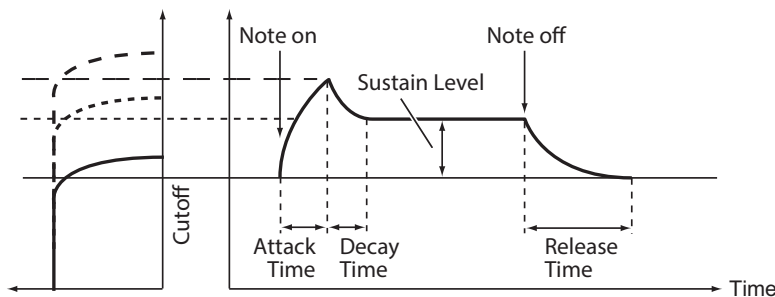
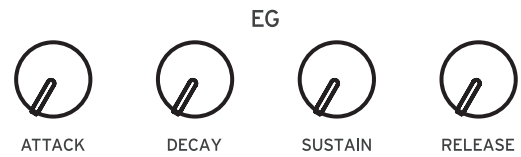

ATTACK knob [0...1023]

The ATTACK specifies the time required for the EG to reach its maximum level once a new note is played.

DECAY knob [0...1023]

The DECAY specifies the time required for the EG to fall to the preset Sustain level once the Attack portion of the EG is complete.

SUSTAIN knob [0...1023]

The SUSTAIN specifies the level that will be maintained while the key is held down (or a trigger is applied).

RELEASE knob [0...1023]

The RELEASE specifies the time required for the EG to reach its minimum level (zero) once the key or trigger is released.

LFO

LFO: Low Frequency Oscillator

The Low Frequency Oscillator creates a repeating cyclical signal. You can choose one of three LFO waveforms.

Depending on its target, the LFO can provide vibrato (PITCH); Tonal changes to the Oscillators (SHAPE); or Wah-Wah (CUTOFF) effects

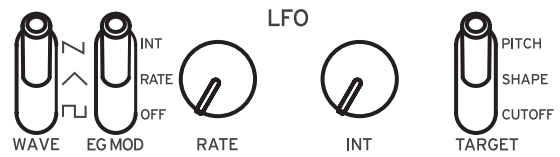

WAVE switch [□, △, ▽]

The LFO can be set to a square wave (□), a triangle wave (△), or a sawtooth wave (▽).

EG MOD switch [OFF, RATE, INT]

The EG can modify either the speed (RATE) or depth (INT) of the LFO, in conjunction with the RATE and INT knobs.

RATE knob [0...1023 / 4, 2, 1, 0, 3/4...1/64]

The rate knob adjusts the speed of the LFO.

Turning the knob to the right will increase the LFO speed.

TIP The values indicated here depend on the LFO BPM Sync settings in the PROGRAM EDIT mode. When LFO BPM Sync is Off, the available values are 0–1023; and when LFO BPM Sync is On, the available values are from 4–1/64 (“LFO BPM Sync”, p. 34).

INT knob [0...1023]

The INT knob adjusts the intensity of the LFO.

Turning the knob to the right will increase the LFO intensity.

TARGET switch [CUTOFF, SHAPE, PITCH]

Selects the parameter where the LFO modulation will be applied.

CUTOFF: Modulation is applied to the FILTER CUTOFF knob setting.

SHAPE: Modulation is applied to the VCO 1, 2 SHAPE knob settings.

PITCH: Modulation is applied to the VCO 1, 2 PITCH knob settings.

DELAY

The Delay effect is combined with a High Pass filter. This allows you to create a wide range of sounds.

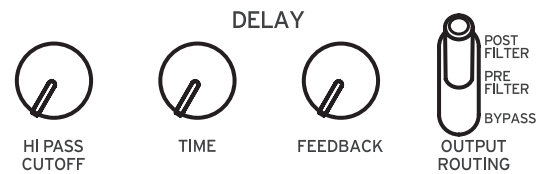

HI PASS CUTOFF knob [0...1023]

Adjusts the cutoff frequency of the high-pass filter. Sounds and harmonic components below the HI-PASS CUTOFF frequency will be attenuated. Turning the knob to the right will increase the cutoff frequency.

TIME knob [0...1023]

This knob specifies the delay time. Turning the knob to the right will make the delay time longer.

FEEDBACK knob [0...1023]

The Feedback knobs controls the regeneration of the Delay effect. Turning the knob to the right will increase the amount of feedback.

OUTPUT ROUTING switch [BYPASS, PRE FILTER, POST FILTER]

Using this switch, you can specify where in the signal chain the Delay effect is being applied.

The circuit routing is shown below. Also, refer to the block diagram (“Block Diagram”, p. 3).

BYPASS: In this mode, the Delay and Hi Pass Filter are bypassed, and no effect is applied to the sound.

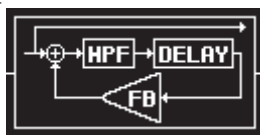

PRE FILTER: The original sound is output before the Hi Pass Filter, and the Hi Pass Filter is applied only to the delayed sound.

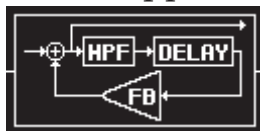

POST FILTER: This Hi Pass Filter is applied to both the original (dry) sound, and the delayed sound.

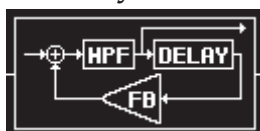

Voice modes

The minilogue is a 4-voice analog synthesizer. By changing the Voice mode, you can combine and allocate the voices in different ways.

The Voice mode is set as a Program parameter, and you can see which Voice mode is being used by looking at which of the buttons 1–8 is lit. For details, refer to “Program List” (p. 54).

There are 8 different Voice modes, and buttons 1–8 are used to switch between them. Turning the VOICE MODE DEPTH knob controls a specific parameter unique to each Voice mode.

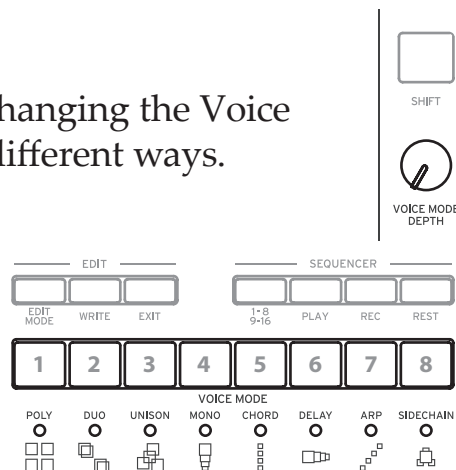

Voice mode list

Button	Voice mode	Action	VOICE MODE DEPTH knob effect
1	POLY	Used for basic playing as a 4-voice poly synth.	[Invert 0..8] Plays an inverted form of the chord that you play on the keyboard. Turning the knob right will invert the chord upwards.
2	DUO	The 4 voices will be stacked together into 2 pairs of 2 voices in unison, as a 2-voice poly synth.	[Detune 0C..50C] Turning the knob to the right will increase the detuning effect.
3	UNISON	The 4 voices will be stacked together into a single voice in unison, as a mono synth.	[Detune 0C..50C] Turning the knob to the right will increase the detuning effect.
4	MONO	The 4 voices will operate as a mono synth with sub-oscillator.	[Sub 0..1023] Turning the knob to the right will assign voices 2 and 3 as a sub-oscillator one octave lower, and turning the knob to the right once more will assign voice 4 as a sub-oscillator two octaves lower.
5	CHORD	The four voices will play as a chord.	[5th, sus2, m, Maj, sus4, m7, 7, 7sus4, Maj7, aug, dim, m7 ^b 5, mMaj7, Maj7 ^b 5] Selects the chord to play.

Button	Voice mode	Action	VOICE MODE DEPTH knob effect
6	DELAY	Voices 2, 3, and 4 will play in delayed sequence after voice 1 plays.	[1/192...1/4] Turning the knob to the right will make the delay time longer.
7	ARP	Uses the arpeggiator to play up to 4 voices. If you push and hold this button, you can toggle latch mode on and off. When latch is on, the arpeggiator will continue to play notes after releasing the keys.	[MANUAL 1, MANUAL 2, RISE 1, RISE 2, FALL 1, FALL 2, RISE FALL 1, RISE FALL 2, POLY 1, POLY 2, RANDOM 1, RANDOM 2, RANDOM 3] Selects the arpeggiator type.
8	SIDE CHAIN	Lowers the volume of the previously-played voice when a new voice is played.	[Depth 0...1023] Turning the knob to the right will increase the volume range by which the previously-played voice is reduced.

Sequencer

In this section, we'll explore real-time recording, step recording, and motion sequence recording, as well as how to edit the recorded sequences (step edit).

Real-Time Recording

Recording a performance

This feature allows you to record your minilogue keyboard performance and to add overdubs in real time.

1. **Press the PLAY button in the SEQUENCER section to play the sequencer.**

The PLAY button will light.

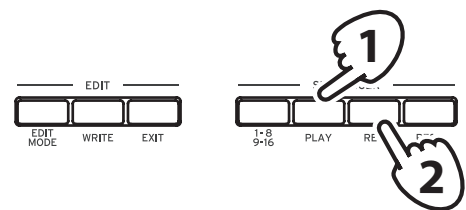

2. **Press the REC button.**

Real-time recording will begin, and the REC button will light.

3. **Play the keyboard.**

The notes that you play on the keyboard will be overdubbed (added to the recording of the sequence data).

4. **Press the REC button once more to stop the recording.**

The REC button will go dark.

TIP Press the REC button once more to start recording again.

5. **Press the PLAY button to finish real-time recording.**

The PLAY button will go dark.

Deleting the sequencer data

Press the REST button to erase or delete existing notes in the sequence during real-time recording.

Step Recording

1. **Press the REC button in the SEQUENCER section while the sequencer is stopped.**

“STEP REC” and “STEP 1” will be indicated in the display.

If the sequence has already been recorded, the note names will be indicated in the display.

TIP Select the step you wish to edit. Use buttons 1–8 to select steps 1–8, and use buttons 9–16 while holding the SHIFT button to select steps 9–16.

2. **Use the keyboard, REST button and other controls to edit the notes.**

When you record a note, rest, or tie in step mode, the display will automatically move to the next step.

Recording notes

The note name for the keys you press on the keyboard will be indicated in the display. Check the note name in the display, and if it is correct, release your finger to record that note and to move to the next step.

If the note name is not correct, just play the correct key while continuing to hold down the wrong key. Check the note indicated in the display, and take your finger off the keyboard to move to the next step.

You can also record chords that you play on the keyboard. The number of notes in a chord will depend on the Voice mode of the current Program (“Voice modes”, p. 23).

TIP The note length during recording is determined by the Default Gate Time value that is set in the SEQ EDIT mode. If you turn the PROGRAM/ VALUE knob while playing the keyboard, the gate time for only the note(s) you played will be changed when recording.

Recording a rest

You can record a rest by pressing the REST button.

Recording a tie

Press the REST button while holding down a key. The note will be tied to the next note and recorded.

3. **When the set number of steps have finished recording, step recording will automatically end. Pressing the REC button at any step during recording will stop the step recording at that step.**

TIP The number of steps is set for each Program, and you can change the number of steps using the Step Length function in the SEQ EDIT mode. For details, refer to “Step Length” (p. 37).

Recording a Motion Sequence

Motion Sequencing allows you to record the flipping of switches and the turning of knobs as part of the sequence, and recreate those motions automatically during playback.

Four Motion Sequences can be recorded on the minilogue, which can include changes to all knobs and switches (except for the MASTER knob, TEMPO knob, and OCTAVE switches).

1. Press the PLAY button to play the sequencer.

2. Press the REC button.

Real-time recording will begin.

3. Move the knobs and switches on the minilogue.

A Motion Sequence of the knobs and switches you moved will be recorded. You can record up to 4 Motion Sequences for the knobs and switches.

If you exceed this limit, the message "Motion Full" will be indicated in the display, and the display will enter MOTION CLEAR in the SEQ EDIT mode. When this happens, delete a previously-recorded Motion Sequence before recording a new one ("Deleting a Motion Sequence", p. 28).

4. After the set number of steps have finished recording, the Motion Sequence will automatically finish recording as well.

Up to 4 Motion Sequences can be recorded, which includes changes to the knobs and switches. Knobs and switches that have already been recorded can be rerecorded as well.

TIP The number of steps is set for each Program, and you can change the number of steps using the "Step Length" function in the SEQ EDIT mode. For details, refer to "Step Length" (p. 37).

Deleting a Motion Sequence

If you try to record a fifth Motion Sequence, the message “Motion Full” will be indicated in the display. When this happens, the display will enter MOTION CLEAR in the SEQ EDIT mode, and you will be able to delete one of the previously recorded Motion Sequences.

1. Check that the minilogue is on the MOTION CLEAR function, in the SEQ EDIT mode.

“MOTION CLEAR” will be indicated in the display. You can delete Motion Sequences one at a time here.

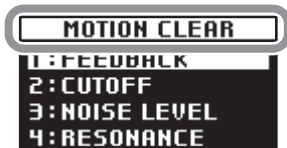

TIP Press the EXIT button to cancel deleting the Motion Sequence.

2. Press button 4, and select the motion to delete.



3. Turn the PROGRAM/VALUE knob to select the message “CLEAR...?”.

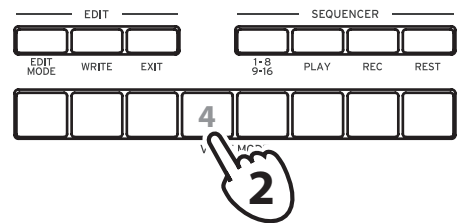

4. Press the WRITE button.

The selected Motion Sequence will be deleted.

5. Press the EXIT button.

6. To continue recording a Motion Sequence, press the REC button, and press the PLAY button to stop.

TIP To delete all Motion Sequences at once, use the “Motion Clear” function assigned to button 3 in the SEQ EDIT mode. For details, refer to “Motion Clear” (p. 38).

Editing sequence data (step edit)

Using Step Edit, you can change the values of notes and gate times previously recorded into a sequence.

1. Select the Program that includes the sequence data you wish to edit.
2. Press the 1–8/9–16 button.

“STEP EDIT 1–8” and “STEP EDIT 9–16” will be indicated in the display.

TIP The number of steps is set for each Program, and you can change the number of steps by turning the PROGRAM/VALUE knob while holding down the SHIFT button. You can also change the number of steps using the “Step Length” function in the SEQ EDIT mode. For details, refer to “Step Length” (p. 37).

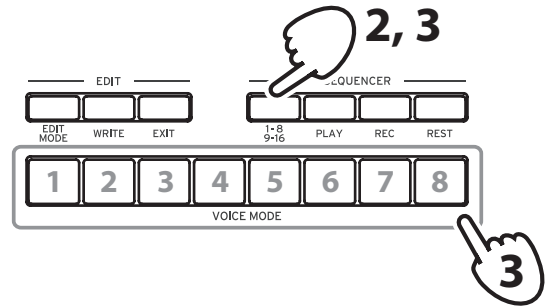

3. Select the step that you want to edit.

To change steps 1–8: Select STEP EDIT 1–8, and then press the one of the buttons from 1 to 8.

To change steps 9–16: Select STEP EDIT 9–16, and then press the one of the buttons from 1 to 8.

The display will indicate “Note”. Play the keyboard to record notes.

Next, press the same button to show the “Gate Time” message in the display, and use the PROGRAM/VALUE knob to change the value.

Button 1 STEP 1/9	Button 2 STEP 2/10	Button 3 STEP 3/11	Button 4 STEP 4/12	Button 5 STEP 5/13	Button 6 STEP 6/14	Button 7 STEP 7/15	Button 8 STEP 8/16
Note	Note	Note	Note	Note	Note	Note	Note
^	^	^	^	^	^	^	^
Button 1	Button 2	Button 3	Button 4	Button 5	Button 6	Button 7	Button 8
v	v	v	v	v	v	v	v
Gate Time	Gate Time	Gate Time	Gate Time	Gate Time	Gate Time	Gate Time	Gate Time

TIP If you hold down the SHIFT button while pressing a button from 1 to 8 that is assigned to the current step, you can delete the note.

 If no note has been recorded, there will be no gate time.

4. Press the EXIT button once you are finished with step editing.

Other editing functions

Use the SEQ EDIT mode when setting the Step Length and Step Resolution parameters during sequence step recording, as well as for deleting sequence data, or for editing or deleting motions. For details, refer to “SEQ EDIT mode” (p. 37).

Edit Mode

Although nearly all of the minilogue's main parameters can be edited using the knobs and switches on the panel, other detailed parameters are accessed using the **Edit mode**.

There are three sub-modes within the Edit mode: **PROGRAM EDIT mode**, **SEQ EDIT mode**, and **GLOBAL EDIT mode**.

How to enter the Edit mode

1. Press the EDIT MODE button.

Each Edit mode is shown in the display, and the buttons light.



2. Press the EDIT MODE button repeatedly—or use the PROGRAM/VALUE knob—to advance to the PROGRAM EDIT mode, SEQ EDIT mode, or GLOBAL EDIT mode.

PROGRAM EDIT mode: This mode is used to change the Program name and assign a parameter to the slider, as well as to initialize Programs and perform other Program editing functions.

SEQ EDIT mode: This mode is used to set the BPM and configure other Step Sequencer settings, to delete sequence data, and so on.

GLOBAL EDIT mode: This mode is used to set the tuning and to specify how the knobs and switches should function, as well as settings that affect the entire synthesizer—such as MIDI.

3. Press one of the buttons 1–6 (or buttons 1–7 in GLOBAL EDIT mode).

The minilogue will enter the selected Edit mode, and the parameter names will be indicated in the display.

Switch to a different page by pressing the same button in succession.

Buttons 1–6 are assigned to specific Edit pages in the **PROGRAM EDIT mode** and the **SEQ EDIT mode** (“PROGRAM EDIT mode”, p. 33) (“SEQ EDIT mode”, p. 37).

Buttons 1–7 are assigned to specific Edit pages in the **GLOBAL EDIT mode** (“GLOBAL EDIT mode”, p. 40).

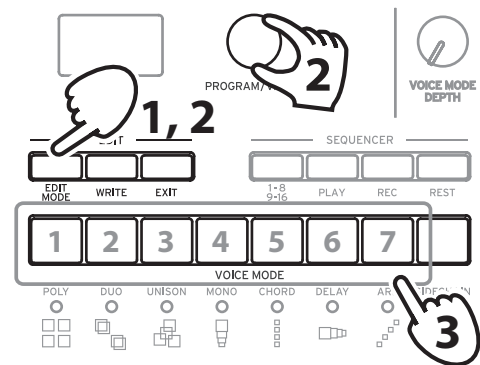

4. **After you have configured the parameters in PROGRAM EDIT mode and/or SEQ EDIT mode, press the WRITE button to save your changes.**
The display will indicate the message “Where to write?”.
 - ▲ If you do not save your changes and select another Program after you have configured the parameters in the PROGRAM EDIT mode and the SEQ EDIT mode, your settings will be lost.
 - TIP** GLOBAL EDIT mode parameters are automatically saved when you switch pages, so there is no need to save them manually.
5. **Use the PROGRAM/VALUE knob to select the destination Program number where you will save your edited sound.**
Press the EXIT button to cancel the save operation and return to Play mode.
6. **Press the WRITE button to save the settings and return to the Play mode.**

PROGRAM EDIT mode

The parameters of the PROGRAM EDIT mode are assigned to buttons 1–6.

Button 1 PROGRAM NAME	Button 2 SLIDER FUNC	Button 3 LFO SETTING	Button 4 OTHER SET- TING	Button 5 INITIALIZE	Button 6 DUMP
PROGRAM NAME	Slider Assign	LFO BPM Sync	Portamento Time	Initialize	Program Dump
	Bend Range +	LFO Key Sync	Portamento Mode		
	Bend Range -	LFO Voice Sync	Portamento BPM		
			Amp Velocity		
			Program Level		

Button 1 (PROGRAM NAME)

You can create a Program Name up to 12 characters in length.

Rotate the PROGRAM/VALUE knob to select the desired character, then press button 1 to move the cursor to the next position.

Button 2 (SLIDER FUNC)

The Slider offers real-time control over a specific parameter of your choosing. In addition, the slider can be used as a pitch bend controller.

Slider Assign

[PITCH BEND...VOICE MODE DEPTH]

You can assign any one these performance parameters to the slider:

- PITCH BEND
- GATE TIME
- VCO 1 PITCH
- VCO 1 SHAPE
- VCO 2 PITCH
- VCO 2 SHAPE
- CROSS MOD DEPTH
- VCO 2 PITCH EG INT

VCO 1 LEVEL
VCO 2 LEVEL
NOISE LEVEL
CUTOFF
RESONANCE
FILTER EG INT
AMP EG ATTACK
AMP EG DECAY
AMP EG SUSTAIN
AMP EG RELEASE
EG ATTACK
EG DECAY
EG SUSTAIN
EG RELEASE
LFO RATE
LFO INT
HPF CUTOFF
DELAY TIME
FEEDBACK
PORTAMENTO
VOICE MODE DEPTH

Bend Range + **[1 Note...12 Note]**

If the Slider is set to PITCH BEND, this parameter specifies how much pitch bend will be applied when moving the slider in the plus (right) direction.

Bend Range - **[1 Note...12 Note]**

If the Slider is set to PITCH BEND, this parameter specifies how much pitch bend will be applied when moving the slider in the minus (left) direction.

Button 3 (LFO SETTING)

There are a number of LFO parameters that relate to various sync functions.

LFO BPM Sync **[Off, On]**

This function allows you to choose whether the LFO frequency will be synchronized with the BPM of the Sequencer.

Off: The LFO frequency will not be synchronized. When the LFO RATE knob is turned, the LFO Rate value changes continuously within the 0–1023 range.

On: The LFO frequency will be synchronized. When the LFO RATE knob is turned, the LFO Rate value will be displayed as the number of beats, such as 4, 2, 1... 1/32, 1/64.

LFO Key Sync [Off, On]

With the LFO Key Sync set to On, the phase of the LFO will be reset with each note-on received from the keyboard.

LFO Voice Sync [Off, On]

Use the LFO Voice Sync to choose whether the phase of the LFO will be synchronized between voices.

Button 4 (OTHER SETTING)

These parameters relate to Portamento, Keyboard Velocity, and the output level of the Program.

Portamento Time [Off, 0...127]

Portamento produces a continuous glide in pitch between notes; this parameter controls the portamento time.

Off: No portamento effect is applied.

The larger the value, the longer the portamento time.

Portamento Mode [Auto, On]

Auto: When playing in a legato style (playing a new note before any previously played note is released), portamento will be applied.

On: Portamento will be applied, even when fully releasing a key and then playing the next note.

Portamento BPM [Off, On]

On: The Portamento Time will be synchronized to the BPM value.

Amp Velocity [0...127]

Amp Velocity is used to specify how much the volume will change according to the keyboard velocity.

0: The velocity will not affect the volume.

The larger the value, the more effect that keyboard velocity will have on volume.

Program Level [-25...+25]

Program Level allows you to adjust the volume of a Program relative to other Programs.

Increasing this value will make the volume louder.

Button 5 (INITIALIZE)

This button initializes the current Program.

Turn the PROGRAM/VALUE knob until “Press WRITE” is indicated in the display. The WRITE button will blink.

Press the WRITE button to initialize the Program. The display will indicate the message “Initialized”.

Button 6 (DUMP)

This button initiates a Program dump.

Turn the PROGRAM/VALUE knob until “Press WRITE” is indicated in the display. The WRITE button will blink.

Press the WRITE button to send a SysEx Program dump from the minilogue’s MIDI OUT and USB B connector. The display will indicate the message “Program Dump”.

SEQ EDIT mode

The parameters of the SEQ EDIT mode are assigned to buttons 1–6.

Button 1 BPM	Button 2 SEQ PARAM- ETER	Button 3 SEQ CLEAR	Button 4 MOTION CLEAR	Button 5 MOTION EN- ABLE	Button 6 MOTION SMOOTH
BPM	Step Length	All Clear	Motion 1...4	Motion 1...4	Motion 1...4
	Step Resolu- tion	Motion Clear			
	Swing				
	Default Gate Time				

Button 1 (BPM)

BPM [10.0...300.0]

This parameter sets the tempo of the Sequencer in Beats Per Minute (BPM).

Button 2 (SEQ PARAMETER)

This group provides control of various Sequencer timing and resolution parameters such as Gate Time, Swing, etc.

Step Length [1...16]

Step Length allows you to set the number of steps used by the Step Sequencer.

Step Resolution [1/16, 1/8, 1/4, 1/2, 1/1]

The Step Resolution is used to set the length of each Step Sequencer step.

1/16: A single step will be set to the length of a sixteenth note.

1/1: A single step will be set to the length of one measure. Use this when you want to play long chords.

Swing [-75%...+75%]

The Swing parameter adjusts the intensity of the swing.

Default Gate Time

[0–100%]

The Gate Time is the default value used for each step recorded using the Step Sequencer. Lower values are more staccato, higher values have a longer gate time.

Button 3 (SEQ CLEAR)

This function provides a convenient way to erase all data within a specific sequence.

All Clear

When using All Clear, all notes and Motion Sequences contained within the sequence data will be deleted.

Turn the PROGRAM/VALUE knob until “Press WRITE” is indicated in the display. The WRITE button will blink.

Press the WRITE button to delete the data. The display will indicate the message “All Cleared”.

Motion Clear

With Motion Clear, only the Motion Sequences contained within the sequence data will be deleted.

Turn the PROGRAM/VALUE knob until “Press WRITE” is indicated in the display. The WRITE button will blink.

Press the WRITE button to delete all of the Motion Sequence data. The display will indicate the message “Motion Cleared”.

Button 4 (MOTION CLEAR)

MOTION CLEAR

Unlike the previous motion clear, Button 4 allows you to clear motions 1–4 individually.

Press button 4 to select the Motion Sequence to delete.

Turn the PROGRAM/VALUE knob until “CLEAR...?” is indicated in the display. The WRITE button will blink.

Press the WRITE button to delete the data. The display will indicate the message “Cleared”.

TIP While the SHIFT button is pressed, the **MOTION VIEW** screen will be displayed, where you can see the waveforms for the Motion Sequences you have recorded. This will not be displayed if a Motion Sequence has not been recorded yet.

Button 5 (MOTION ENABLE)

MOTION ENABLE [OFF, ON]

By setting this function to OFF, you can disable a particular motion without deleting the data.

Press button 5 to select the Motion Sequence to configure.

Turn the PROGRAM/VALUE knob, and select either "OFF" or "ON".

OFF: The Motion Sequence will be disabled, and the parameters will not change (the recorded Motion Sequence will not be deleted).

TIP While the SHIFT button is pressed, the **MOTION VIEW** screen will be displayed, where you can see the waveforms for the Motion Sequences you have recorded. This will not be displayed if a Motion Sequence has not been recorded yet.

Button 6 (MOTION SMOOTH)

MOTION SMOOTH [OFF, ON]

The motion of a Motion Sequence can step from one value to the next, or it can transition smoothly from one value to the next by applying Motion Smooth.

Press button 6 to select the Motion Sequence to configure, and turn the PROGRAM/VALUE knob to select either "OFF" or "ON".

OFF: The Motion Sequence will make changes to the sound in steps.

ON: The Motion Sequence will change smoothly, and make smooth changes to the sound.

TIP While the SHIFT button is pressed, the **MOTION VIEW** screen will be displayed, where you can see the waveforms for the Motion Sequences you have recorded. This will not be displayed if a Motion Sequence has not been recorded yet.

GLOBAL EDIT mode

Unlike PROGRAM EDIT and SEQ EDIT parameters which apply only to the current Program GLOBAL EDIT functions apply to the entire minilogue universally.

GLOBAL EDIT mode parameters are assigned to buttons 1–7.

Button 1	Button 2	Button 3	Button 4	Button 5	Button 6	Button 7
GLOBAL 1	GLOBAL 2	GLOBAL 3	GLOBAL 4	GLOBAL 5	GLOBAL 6	GLOBAL 7
Master Tune	Knob Mode	Sync In Unit	MIDI Ch	Parameter Disp	Brightness	All Dump (USB)
Transpose	Audio In	Sync Out Unit	Clock Source	Oscilloscope	Auto Power Off	All Dump (MIDI)
	Local SW	Sync In Polarity	Enable Rx MIDI			
	Velocity Curve	Sync Out Polarity	Enable Tx MIDI			
			MIDI Route			

Button 1 (GLOBAL 1)

Common to both Oscillators, these functions control the tuning and transposition of the minilogue.

Master Tune [-50 Cent...+50 Cent]

This adjusts the overall tuning of the entire minilogue in one-cent units (semitone = 100 cents), over a range of ± 50 cents.

0: A4 is equal to 440 Hz.

Transpose [-12 Note...+12 Note]

Transposing the keyboard allows you play in a different key using familiar fingerings on the keyboard.

Button 2 (GLOBAL 2)

These functions relate to performance aspects of the minilogue—knob operation, velocity curves, local settings, and more.

Knob Mode [Jump, Catch, Scale]

The front panel knobs can operate in one of three modes:

Jump: When you turn the knob, the parameter value will jump to the value indicated by the knob. Since this makes it easy to hear the results while editing, we recommend that you use this setting.

Catch: Turning the knob will not change the parameter value until the knob position matches the stored value. We recommend that you use this setting when you don't want the sound to change abruptly, such as while performing.

Scale: When you turn the knob, the parameter value will increase or decrease in a relative manner in the direction that it is turned. When you turn the knob and it reaches the full extent of its motion, it will operate proportionate to the maximum or minimum value of the parameter. Once the knob position matches the parameter value, the knob position and parameter value will subsequently be linked.

If the parameter value does not change

In some cases, the parameter value may not change or Motion Sequence recording may not start, even when you turn the knob from left to right. This means that the knob mode is set to “Catch”.

In this case, the actual value of the parameter you're editing (the value shown in the display) will not change unless it matches the position of the knob. In Catch mode, the knob position and the value will be linked only when the knob position reaches the actual value. This prevents an unnatural change in sound that is caused when a value suddenly changes.

Let's say that you've turned the knob to edit a certain parameter, and that the knob is in the position shown.



The actual value of the parameter is at the position shown by the triangle.

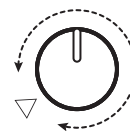

The parameter value will not change until the knob position reaches the triangle mark.

Once the knob has reached the position corresponding to the actual value, the parameter value and the knob position will be linked, and the value will change as you turn the knob.



Audio In [Off, On]

The audio input jack can be globally enabled or disabled.

Off: Any audio signals coming into the jack will be muted.

Local SW

[Off, On]

The local connection makes a link between the minilogue keyboard the sound-generating circuitry. Normally, this link is On. However, if you are using the minilogue with an external sequencer or sequencing software, you will want to set the local connection to OFF to eliminate the double-triggering of notes caused by MIDI echo.

Off: The minilogue's keyboard will be internally disconnected from the tone generator.

Velocity Curve

[Type 1...8, Const 127]

Changing the Velocity Curve allows you to match the dynamic response of the minilogue keyboard to your own playing style and technique.

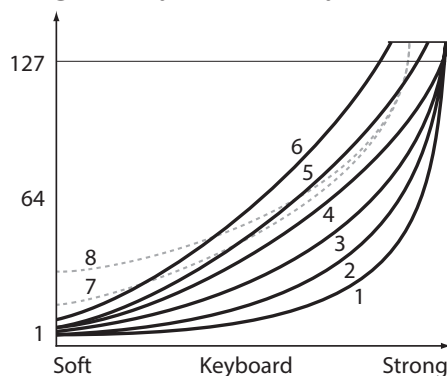

Type 1	This curve requires you to play strongly in order to produce an effect.
Type 2, 3	:
Type 4	This is a typical curve.
Type 5	:
Type 6	This curve produces an effect without requiring you to play very strongly.
Type 7	This curve produces a fairly steady effect with little change for medium-strength playing.
Type 8	This curve produces a fairly steady effect with little change for medium-strength playing (a flatter curve than 7).
Const 127	All notes will sound at maximum velocity.

Curve types 7 and 8 produce little change for medium-strength playing, and are suitable when keyboard velocity is not required, or when you want to play each note at the same velocity. However, these curves will produce a great deal of change with softly played notes, so the sound may be more difficult to control. Choose the curve that is most appropriate for your playing dynamics or for the effect you want to obtain.

Button 3 (GLOBAL 3)

These parameters relate to the SYNC IN/SYNC OUT jack settings.

Sync In Unit [16th Note, 8th Note]

The Sync In Units determine how much the Sequencer will advance with each pulse received via the SYNC IN jack.

16th Note: The Sequencer will advance one sixteenth note for each pulse.

8th Note: The Sequencer will advance one eighth note for each pulse.

TIP When Step Resolution in the SEQ EDIT mode is set to 1/16, a sixteenth note will be equal to one step, and an eighth note will be equal to two steps.

Sync Out Unit [16th Note, 8th Note]

The Sync Out Units determine how far the Sequencer needs to advance in order to generate a pulse via the SYNC OUT jack.

16th Note: A pulse will be outputted for every sixteenth note.

8th Note: A pulse will be outputted for every eighth note.

TIP When Step Resolution in the SEQ EDIT mode is set to 1/16, a sixteenth note will be equal to one step, and an eighth note will be equal to two steps.

Sync In Polarity [Rise, Fall]

In order to achieve synchronization with other units, the polarity of the SYNC IN jack may need to be changed.

Rise: The minilogue will sync to the pulse as it rises to its crest (the highest point) of the waveform.

Fall: The minilogue will sync to the pulse as it falls to its trough (the lowest point) of the waveform.

Sync Out Polarity [Rise, Fall]

In order for other units to correctly sync with the minilogue, the polarity of the SYNC OUT jack may need to be changed.

Rise: The minilogue will create a sync pulse as it rises to its crest (the highest point) of the waveform.

Fall: The minilogue will create a sync pulse as it falls to its trough (the lowest point) of the waveform.

Button 4 (GLOBAL 4)

These parameters relate to the minilogue's MIDI capabilities.

MIDI Ch [1...16]

In order to communicate, the minilogue and your other MIDI devices must be set to the same MIDI channel. This is both the Transmit and Receive channel.

Clock Source [Auto (USB), Auto (MIDI), Internal]

Many features of the minilogue can be sync'd to the tempo or BPM. This parameter allows you to specify whether the clock source is internal, or an external MIDI Clock Source.

Auto (USB), Auto (MIDI): When there is no input, the internal clock will be used; and when input is detected, the internal clock will be synchronized to the clocks from the USB B and MIDI IN connectors respectively.

Internal: Only the internal clock to be used.

- 🔊 When a cable is plugged into the SYNC IN jack, the internal clock is synchronized to the SYNC IN jack clock, regardless of the MIDI clock settings.

Enable Rx MIDI [Off, On]

Set this parameter to ON to allow the minilogue to receive MIDI messages.

Enable Tx MIDI [Off, On]

Set this parameter to ON to allow the minilogue to transmit MIDI messages.

MIDI Route [USB+MIDI, USB]

MIDI signals can be sent and received via the MIDI and USB connectors, or by the USB connector alone.

USB+MIDI: MIDI messages are received via the USB B connector and the MIDI IN connector; messages are transmitted from the USB B connector and the MIDI OUT connector.

USB: MIDI messages will be transmitted and received only via the USB B connector. When using the USB connector as a MIDI interface, it is advantageous to use this setting.

Button 5 (GLOBAL 5)

These parameters relate to the minilogue's display, and what information is seen there.

Parameter Disp [Normal, All]

Normal: Only major information such as operating the pitch-related knobs or switching the OUTPUT ROUTING switch will be displayed.

All: When any knob except for the MASTER knob is turned, the value is indicated; and when operating a switch, the setting is indicated.

Oscilloscope [Disable, Enable]

In place of the Program name and number, the **oscilloscope feature** can be used to show a waveform tracing of the sound.

Disable: The display will indicate the Program name and number..

Enable: The sound will be displayed as an electrical signal (waveform).

Button 6 (GLOBAL 6)

These parameters relate to the minilogue's display and power settings.

Brightness [1...10]

Adjusts the display brightness.

- ⚠ Continuous use of the minilogue while the brightness is set to a high value will have an adverse effect on the overall life of the display.

Auto Power Off [Off, On]

Using the Auto Power Off feature, the minilogue can be set to automatically turn off after approximately four hours have elapsed without any operation of the knobs, switches, or keyboard, and without any input. Once this occurs, you will need to turn the minilogue on again manually.

Off: The Auto Power Off feature will be disabled.

On: The Auto Power Off feature is enabled. For details, refer to "Auto Power Off Feature" (p. 7)

Button 7 (GLOBAL 7)

These parameters allow you to perform a dump of all the internal data, either via MIDI or via USB.

All Dump (USB)

Turn the PROGRAM/VALUE knob until “Press WRITE” is indicated in the display. The WRITE button will blink.

Press the WRITE button to transmit the MIDI data dump via the USB B connector. The display will indicate the message “Transmitting”. The data will take about 10 seconds to transmit.

- ⚠ If the USB cable is not connected, or if the MIDI IN port on the PC is not open, the data will not be transmitted.

All Dump (MIDI)

Turn the PROGRAM/VALUE knob until “Press WRITE” is indicated in the display. The WRITE button will blink.

Press the WRITE button to transmit the MIDI data dump via the MIDI OUT connector. The display will indicate the message “Transmitting”. The data will take about 30 seconds to transmit.

Other functions

Tuning

As with all analog instruments, the minilogue's circuitry can drift over time during performance due to changes in environment and temperature. The minilogue provides an **auto-tuning function** that automatically tunes the instrument's analog circuits on demand, to correct for any analog drift..

As you continue to play the minilogue for a while right after you've turned it on, the pitch and tone may gradually drift. If the pitch drift becomes noticeable, use the steps below to tune the instrument. This will manually bring the minilogue back into tune.

- 1. Press the REC button while holding down the SHIFT button.**

Tuning will begin, and the display will indicate "Tuning...".

The tuning will take about 15 seconds.

 During tuning, you will temporarily be unable to play the minilogue.

Restoring the Factory settings

You can restore the minilogue's preset Programs and global settings to their original factory-set state at any time.

- 1. Begin with the minilogue turned Off.**

- 2. While holding down the WRITE button and the EXIT button, turn the minilogue On.**

"FACTORY RESET" will be indicated in the display.

- 3. Turn the PROGRAM/VALUE knob to select the items you wish to reset to the factory default settings.**

PRESET: Restores the preset Programs (Programs 1–100) to their factory-set default settings.

 This will replace the existing preset Programs with the factory-set default Programs. If you want to keep the existing preset Programs beforehand, press the WRITE button to save the presets to the user Programs (Programs 101–200).

GLOBAL: Restores the GLOBAL settings to their factory default settings. This also includes any favorite Programs that you have registered.

ALL: Restores the preset Programs (Programs 001–100), Programs 101–200, and GLOBAL settings to their factory-set default settings.

 Use caution, as this will replace all data with the factory-set default settings (which will erase your user Programs).

4. Press the WRITE button.

The display will indicate the message “Are you sure?”.

5. Turn the PROGRAM/VALUE knob to select “Yes”, and press the WRITE button.

The factory-set default data will be reloaded, and the minilogue will be restored to its factory default state.

TIP Press the EXIT button, or select “No” using the PROGRAM/VALUE knob and press the WRITE button to cancel the operation.

 Never turn off the minilogue while data is being loaded.

Shortcuts using the SHIFT button

By holding down the SHIFT button as you press other select buttons, you can access a number of convenient features quickly and easily.

Function	SHIFT button +	
Load panel information	When in Play mode: PLAY button	Loads the state of the front panel switches and knobs into the selected Program. Used to make the sound match the state of the controls on the front panel.
Tuning	When in Play mode: REC button	When the minilogue's sound generator is not making any sound, auto-tuning occurs automatically; but you can use this function to re-tune the minilogue manually in Play mode if the tuning seems to be drifting. The internal temperature tends to change more right after the power is turned on, which may cause the instrument to go out of tune. Press the REC button while holding down the SHIFT button again to cancel manual tuning, if you accidentally started it by mistake.
Delete sequence data	When in Play mode: REST button	Deletes all sequence data for the selected Program (including notes and Motion Sequence settings). Press the REC button while holding down the SHIFT button again before doing anything else to cancel deleting the sequence data, if you accidentally started this operation by mistake.
Select a Program	When in Play mode: PROGRAM/VALUE knob	Skips the selected Program forward or backwards, in increments of 10.
Select a favorite Program	When in Play mode: Buttons 1–8	Selects a Program that has been registered as a favorite Program.
Set the step length	While in Step Edit: PROGRAM/VALUE knob	Allows for the step length value to be changed.
Select the step	While in Step Edit: Buttons 1–8	When the current step selected is at 1–8, this selects steps 9–16. When the current step selected is at 9–16, this selects steps 1–8.

Understanding MIDI

MIDI stands for Musical Instrument Digital Interface, and is a worldwide standard for exchanging various types of musical data between electronic musical instruments and computers.

When MIDI cables are used to connect two or more MIDI devices, performance data can be exchanged between the devices, even if they were made by different manufacturers.

MIDI data can also be exchanged between the minilogue and your personal computer using a single USB cable. The minilogue lets you assign MIDI control change numbers (CC#) to the major parameters that affect the sound, and control these parameters from an external MIDI sequencer while you play the tone generator. You can also use the front panel knobs or buttons to transmit these control change messages, in order to control an external MIDI device.

You can also synchronize the minilogue's tempo to the MIDI clock of an external MIDI sequencer or other device, so that the minilogue will play in time with the external device and with any changes you make.

Connecting Devices via MIDI and USB

Controlling an external MIDI device from the minilogue

If you want to use the minilogue's keyboard, controllers, and sequencer to play sounds on or to control an external MIDI tone generator, connect the minilogue's MIDI OUT connector to the external MIDI tone generator's MIDI IN connector using a MIDI cable.

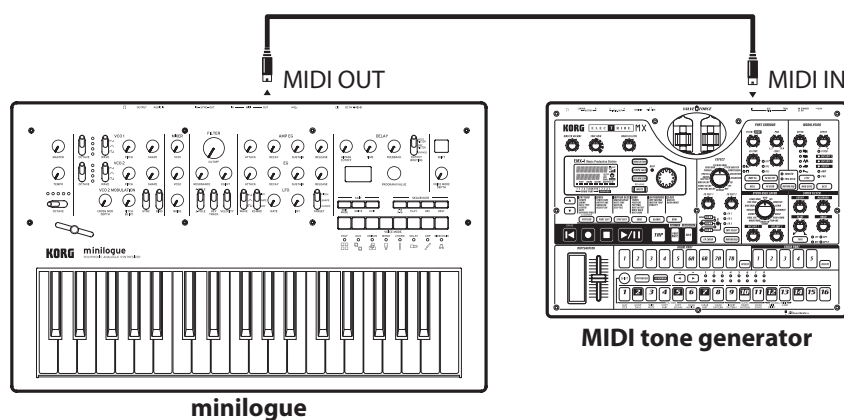

Controlling the minilogue from an external MIDI device

If you want to play or control the minilogue from another MIDI keyboard, sequencer, or other device, connect the MIDI OUT connector of the external MIDI device to the minilogue's MIDI IN connector with a MIDI cable.

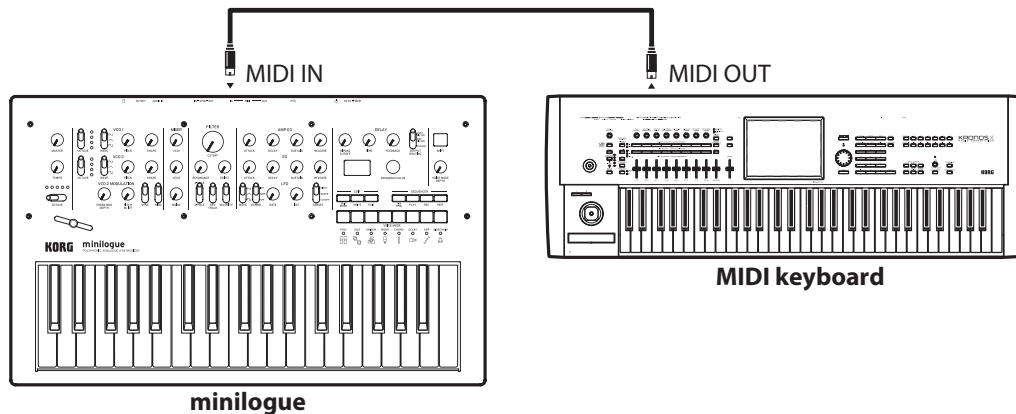

Connecting the minilogue to a computer via MIDI

You might want to play the minilogue's keyboard and record your performance on an external MIDI sequencer or computer (connected using the MIDI interface), and then play the minilogue while monitoring or playing back what you recorded. You also might want to use the minilogue as both an input device for playing notes and as a MIDI tone generator. In either case, you'll need to connect the MIDI OUT connector to the MIDI IN connector on both the minilogue and the external MIDI sequencer or computer.

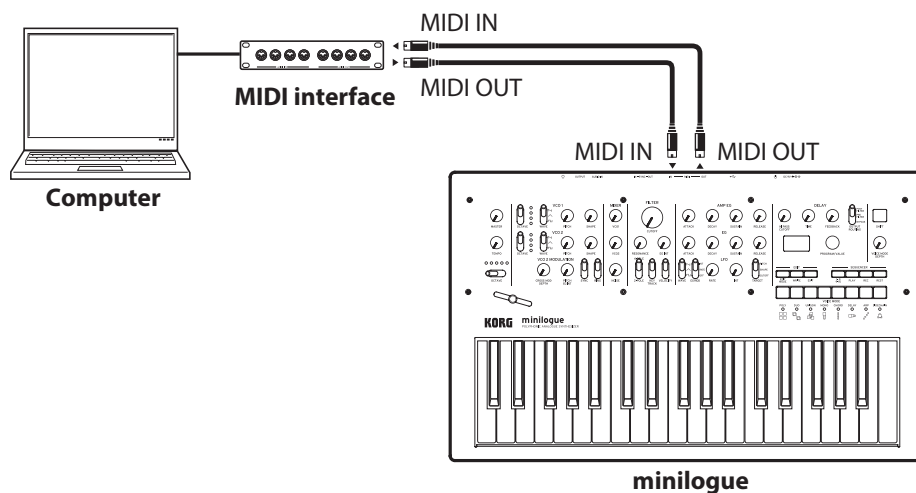

⚠ Some MIDI interface devices may be unable to transmit or receive MIDI SysEx messages to or from the minilogue.

TIP It's convenient to use the USB connector when connecting the minilogue to a personal computer.

Connecting the minilogue to a computer via USB

In order to use a USB connection, you'll need to install the Korg USB-MIDI driver on your computer. Download the "Korg USB-MIDI driver" from the Korg website, and install it as described in the accompanying documentation.

- 🔗 If either the MIDI connection or the USB connection is not working properly, check the settings in button 4 ("MIDI Route") of the GLOBAL EDIT mode ("MIDI Route", p. 44).

MIDI-Related Settings

Setting the MIDI channel

In order to exchange data with a connected external MIDI device, you must set the minilogue's MIDI channel to match the MIDI channel of the external MIDI device.

Use the button 4 (MIDI Ch) in the GLOBAL EDIT mode to set the minilogue's MIDI channel ("MIDI Ch", p. 44).

- TIP** When synchronizing to an external MIDI device, refer to that device's Owner's manual.

Configuring the MIDI "LOCAL" setting when connected to an external MIDI sequencer or computer

The Echo Back setting of your external MIDI sequencer or computer system allows the MIDI notes and other messages being played by the minilogue to be instantly passed along to any other MIDI equipment, including synthesizers, tone generators. However, this same Echo Back function can cause the minilogue to double trigger: once when you play the note, and a second time as the external MIDI sequencer or computer system sends the note back to the minilogue. To prevent this from happening, you can simply disable the LOCAL connection between the minilogue keyboard and the tone generating circuitry. The LOCAL feature is accessed using button 2 (Local SW) in the GLOBAL EDIT mode ("Local SW", p. 42).

Configuring the minilogue to transmit and receive short MIDI messages

The minilogue can be configured to enable or disable the receiving or transmission of MIDI short messages.

To receive or transmit MIDI short messages, turn the “Enable Rx MIDI” and “Enable Tx MIDI” settings on using button 4 in the GLOBAL EDIT mode (“Enable Rx MIDI”, p. 44) (“Enable Tx MIDI”, p. 44).

Synchronizing the Sequencer

Use the “Clock Source” setting on button 4 in the GLOBAL EDIT mode to set whether the minilogue will be the master (the device controlling the synchronization) or the slave (the device being controlled) when the Sequencer is played (“Clock Source”, p. 44).

TIP When synchronizing to an external MIDI device, refer to that device’s Owner’s manual.

Using the minilogue as the master to slave external MIDI devices

Connect the MIDI OUT connector of the minilogue to the MIDI IN connector on your external MIDI device(s).

In the GLOBAL EDIT mode, set the Clock Source of the minilogue to “Internal”, and configure the external MIDI device to receive clock data via MIDI. The minilogue will act as the master, and the tempo that is set using the TEMPO knob on the minilogue will be sent as MIDI timing clock data to operate the external MIDI device (sequencers, rhythm machines, and so on).

Slaving the minilogue clock to an external MIDI device

Connect the MIDI IN connector of the minilogue to the MIDI OUT connector on your external MIDI device.

In the GLOBAL EDIT mode, set the Clock Source of the minilogue to “Auto (MIDI)”, and configure the external MIDI device to transmit MIDI clock data. The minilogue will automatically act as the slave whenever a MIDI timing clock is received, and will be driven by the tempo of the external MIDI device (sequencers, rhythm machines, and so on).

TIP Even if you set the Clock Source to “Auto (USB)” or “Auto (MIDI)”, the minilogue will operate in “Internal” MIDI clock mode, unless a clock is received from an external device.

Program List

No.	Program Name	Category	Voice Mode	Slider Assign	Author
1	PolyLogue	Poly Synth	POLY	PITCH BEND	KORG Inc.
2	PWM Strings	Poly Synth	POLY	PITCH BEND	KORG Inc.
3	Flutter Pad	Poly Synth	POLY	LFO INT	KORG Inc.
4	TraxBass	Bass	UNISON	EG DECAY	KORG Inc.
5	Ultra Low	Bass	MONO	FILTER EG INT	KORG Inc.
6	Stardom Lead	Lead	DUO	PITCH BEND	KORG Inc.
7	Fluctuation	Lead	DUO	PITCH BEND	KORG Inc.
8	King Cheetah	Chord	CHORD	EG DECAY	Jimmy Edgar
9	PolySeek	Arp	ARP	EG DECAY	KORG Inc.
10	Magic Spells	SFX	DELAY	VCO 2 PITCH EG INT	Richard Devine
11	Stabber	Poly Synth	POLY	PITCH BEND	KORG Inc.
12	S.F. Key	Poly Synth	POLY	PITCH BEND	KORG Inc.
13	Late Summer	Poly Synth	POLY	PITCH BEND	KORG Inc.
14	Scuba Diving	Poly Synth	POLY	PITCH BEND	Jimmy Edgar
15	Soft Brass	Poly Synth	POLY	PITCH BEND	KORG Inc.
16	Wah Clav	Poly Synth	POLY	PITCH BEND	KORG Inc.
17	FilterMotion	Poly Synth	POLY	PITCH BEND	Jimmy Edgar
18	Sing(bout u)	Poly Synth	SIDE CHAIN	PITCH BEND	KORG Inc.
19	PluckMouse	Poly Synth	POLY	PITCH BEND	KORG Inc.
20	PopperSynth	Poly Synth	POLY	PITCH BEND	KORG Inc.
21	Cosmic Love	Poly Synth	POLY	PITCH BEND	Jimmy Edgar
22	Louge Pad	Poly Synth	POLY	VCO 2 PITCH	KORG Inc.
23	Pulse Pad	Poly Synth	POLY	PITCH BEND	Richard Devine
24	Liquid Pad	Poly Synth	POLY	PITCH BEND	Richard Devine
25	Prospero	Poly Synth	POLY	PITCH BEND	Richard Devine
26	Burn Low	Poly Synth	DUO	PITCH BEND	KORG Inc.
27	Polymonk	Poly Synth	POLY	PITCH BEND	KORG Inc.
28	Yes or No	Poly Synth	POLY	PITCH BEND	KORG Inc.
29	OuterSpace	Poly Synth	POLY	PITCH BEND	KORG Inc.
30	Morning Gt.	Poly Synth	POLY	PITCH BEND	KORG Inc.
31	Ugly Ducking	Poly Synth	SIDE CHAIN	PITCH BEND	KORG Inc.
32	Unwilling	Poly Synth	SIDE CHAIN	PITCH BEND	KORG Inc.
33	Mountain	Poly Synth	POLY	PITCH BEND	KORG Inc.
34	Old Elba	Poly Synth	POLY	PITCH BEND	Richard Devine
35	Lipstick	Poly Synth	POLY	PITCH BEND	Jimmy Edgar
36	Rubber Band	Poly Synth	POLY	PITCH BEND	Jimmy Edgar
37	Vintage Tine	Poly Synth	POLY	PITCH BEND	Richard Devine
38	Chico Synth	Poly Synth	POLY	PITCH BEND	Jimmy Edgar
39	Dice Synth	Poly Synth	POLY	PITCH BEND	Jimmy Edgar
40	Joyful	Poly Synth	POLY	PITCH BEND	Jimmy Edgar
41	Majenta	Poly Synth	POLY	PITCH BEND	Jimmy Edgar
42	TriBell	Poly Synth	POLY	PITCH BEND	KORG Inc.
43	Pluckey	Poly Synth	POLY	PITCH BEND	KORG Inc.
44	Old MusicBox	Poly Synth	POLY	PITCH BEND	KORG Inc.
45	NoiseScope	Poly Synth	POLY	PITCH BEND	KORG Inc.
46	Flutes Key	Poly Synth	POLY	PITCH BEND	KORG Inc.
47	Universe Luv	Poly Synth	POLY	PITCH BEND	Jimmy Edgar
48	Accordion	Poly Synth	POLY	PITCH BEND	KORG Inc.
49	Dirt Bass	Bass	MONO	PITCH BEND	KORG Inc.
50	QueBass	Bass	MONO	VCO 2 PITCH	KORG Inc.

No.	Program Name	Category	Voice Mode	Slider Assign	Author
51	Mega PopBass	Bass	POLY	PITCH BEND	Richard Devine
52	OctaBass	Bass	MONO	PITCH BEND	KORG Inc.
53	BassRide	Bass	MONO	EG DECAY	KORG Inc.
54	Dark Bass	Bass	UNISON	PITCH BEND	Richard Devine
55	Detuned Acid	Bass	MONO	GATE TIME	KORG Inc.
56	Nasal Bass	Bass	MONO	PITCH BEND	Richard Devine
57	RingBase	Bass	UNISON	PITCH BEND	KORG Inc.
58	Housey Bass	Bass	MONO	PITCH BEND	KORG Inc.
59	Rhino Bass	Bass	MONO	PITCH BEND	Jimmy Edgar
60	Dungeon	Bass	UNISON	PITCH BEND	Jimmy Edgar
61	StackBass	Bass	UNISON	PITCH BEND	KORG Inc.
62	Organ Bass	Bass	MONO	PITCH BEND	KORG Inc.
63	Passing Step	Bass	DUO	PITCH BEND	KORG Inc.
64	Sterlie Bass	Bass	DUO	PITCH BEND	Jimmy Edgar
65	Hoovaaa	Bass	UNISON	PITCH BEND	KORG Inc.
66	Fallen Rock	Bass	UNISON	PITCH BEND	KORG Inc.
67	Runaway Lead	Lead	UNISON	PITCH BEND	KORG Inc.
68	G-Lead	Lead	MONO	PITCH BEND	KORG Inc.
69	Panic Lead	Lead	MONO	PITCH BEND	KORG Inc.
70	Unison Lead	Lead	UNISON	PITCH BEND	KORG Inc.
71	CutLead	Lead	UNISON	PITCH BEND	KORG Inc.
72	Cyber Lead	Lead	DELAY	PITCH BEND	KORG Inc.
73	Sweep Lead	Lead	MONO	PITCH BEND	KORG Inc.
74	Jimmy Vision	Lead	DUO	PITCH BEND	Jimmy Edgar
75	Vibe Lead	Lead	MONO	PITCH BEND	KORG Inc.
76	ManzLead	Lead	MONO	PITCH BEND	KORG Inc.
77	Da Lead	Lead	MONO	PITCH BEND	KORG Inc.
78	Oct Uni Sync	Lead	MONO	PITCH BEND	KORG Inc.
79	Delay Seq_1	Lead	DELAY	PITCH BEND	KORG Inc.
80	Third Eye	Lead	UNISON	PITCH BEND	KORG Inc.
81	DualSonic	Lead	DUO	PITCH BEND	KORG Inc.
82	Deephit	Chord	CHORD	PITCH BEND	KORG Inc.
83	Halftime Hit	Chord	CHORD	PITCH BEND	Jimmy Edgar
84	HarmorChord	Chord	CHORD	PITCH BEND	Richard Devine
85	SunnyDetroit	Chord	CHORD	PITCH BEND	Richard Devine
86	Crystal Band	Chord	CHORD	PITCH BEND	Jimmy Edgar
87	Foggy Morn	Chord	CHORD	PITCH BEND	Jimmy Edgar
88	Teleport 1-2	Chord	CHORD	PITCH BEND	KORG Inc.
89	Thoth Arp	Arp	ARP	PITCH BEND	Jimmy Edgar
90	BlinkyLead	Arp	ARP	PITCH BEND	Richard Devine
91	Arp Bass	Arp	ARP	PITCH BEND	KORG Inc.
92	Password	Arp	ARP	PITCH BEND	KORG Inc.
93	Drip City	Arp	ARP	PITCH BEND	Richard Devine
94	Heeler Seq	Arp	ARP	GATE TIME	KORG Inc.
95	Dream Seq	SFX	CHORD	PITCH BEND	Jimmy Edgar
96	Spark!	SFX	MONO	PITCH BEND	KORG Inc.
97	Mono Growl	SFX	MONO	EG SUSTAIN	KORG Inc.
98	NoisyPopToms	SFX	DELAY	EG DECAY	KORG Inc.
99	Motion Beat	SFX	MONO	PITCH BEND	Jimmy Edgar
100	Beat Salad	SFX	POLY	PITCH BEND	Jimmy Edgar
101					
:	Init Program		POLY		
200					

For more information about the authors please visit:

Richard Devine

<https://soundcloud.com/richarddevine>

<https://instagram.com/richarddevine/>

<https://vimeo.com/richarddevine>

<http://www.devsnd.blogspot.com/>

JIMMY EDGAR

<http://jimmyedgar.com/>

Specifications

Keyboard:	37 keys (slim keyboard, velocity sensitive)
Maximum polyphony:	4 voices
Sound generating system:	2 VCO (square wave, triangle wave, sawtooth wave) 1 VCF (2-pole, 4-pole) 2 EG 1 VCA 1 LFO DELAY
Input/output jacks:	Headphones jack OUTPUT jack AUDIO IN jack SYNC IN jack (ø3.5 mm stereo mini-phone jack, 20V maximum input level) SYNC OUT jack (ø3.5 mm stereo mini-phone jack, 5V output level) MIDI IN connector MIDI OUT connector USB B connector
Power supply:	AC adapter (DC 9V )
Power consumption:	8 W
Dimensions (W x D x H):	500 x 300 x 85 mm 19.69 x 11.81 x 3.35 inches
Weight:	2.8 kg 6.17 lbs.
Operating temperature:	0–+40 °C (non-condensing)
Accessories:	AC adapter, Quick Start Guide, Precautions

* Specifications and appearance are subject to change without notice for improvement

* All product names and company names are the trademarks or registered trademarks of their respective owners.

MIDI Implementation Chart

Function...		Transmitted	Received	Remarks
Basic Channel	Default	1-16	1-16	Memorized
	Change	1-16	1-16	
Mode	Default	X	3	
	Messages	X	X	
	Altered	*****		
Note Number		0-127	0-127	*1
	True Voice	*****	0-127	
Velocity	Note On	O 9n, V=1-127	O 9n, V=1-127	
	Note Off	X 8n, V=64	X	
After Touch	Key's	X	X	
	Channel	X	X	
Pitch Bend		O	O	
Control Change	0, 32	O	O	Bank Select (MSB, LSB) *1
	16-23	O	O	AMP EG (ADSR), EG (ADSR) *1
	24, 26, 27	O	O	LFO (RATE, DEPTH), VOICE DEPTH *1
	29-31	O	O	DELAY (HI PASS, TIME, FEEDBACK) *1
	34-37	O	O	PITCH(VCO1,2), SHAPE(VCO1,2) *1
	33, 39, 40	O	O	LEVEL(NOISE, VCO1,2) *1
	41, 42	O	O	CROSS MOD DEPTH, PITCH EG INT *1
	43-45	O	O	FILTER(CUTOFF, RESONANCE, EG INT) *1
	48-51	O	O	OCTAVE(VCO 1,2), WAVE(VCO 1,2) *1
	56-58	O	O	LFO (TARGET, EG MOD, WAVE) *1
	80, 81	O	O	SYNC, RING *1
82, 83	O	O	VELOCITY KEY TRACK, KEYBOARD TRACK *1	
84, 88	O	O	FILTER TYPE, DELAY OUTPUT ROUTING *1	
Program Change		O 0-99	O 0-99	*1
	True Number	*****	0-99	
System Exclusive		O	O	
System Common	Song Position	X	X	
	Song Select	X	X	
	Tune Request	X	X	
System Real Time	Clock	O	O	*2
	Commands	O	O	
Aux Meassages	Local On/Off	X	O	*3
	All Notes Off	X	O	*3
	Active Sense	O	O	
	System Reset	X	X	
Notes *1: When the Global setting is "Enable Tx MIDI=On", the minilogue will transmit signals; and when the Global setting is "Enable RX MIDI=ON", the minilogue will receive signals. *2: When the Global setting is "Clock Source=Internal", the minilogue will not receive signals. The minilogue will receive signals when set to "Auto(MIDI)" or "Auto(USB)". *3: When the Global setting is "Enable RX MIDI=ON", the minilogue will receive signals.				

Mode 1: Omni On, Poly
 Mode 3: Omni Off, Poly

Mode 2: Omni On, Mono
 Mode 4: Omni Off, Mono

O: Yes
 X: No

Consult your local Korg distributor for more information on MIDI implementation.

KORG INC.

4015-2 Yanokuchi, Inagi-City, Tokyo 206-0812 JAPAN

© 2016 KORG INC.