

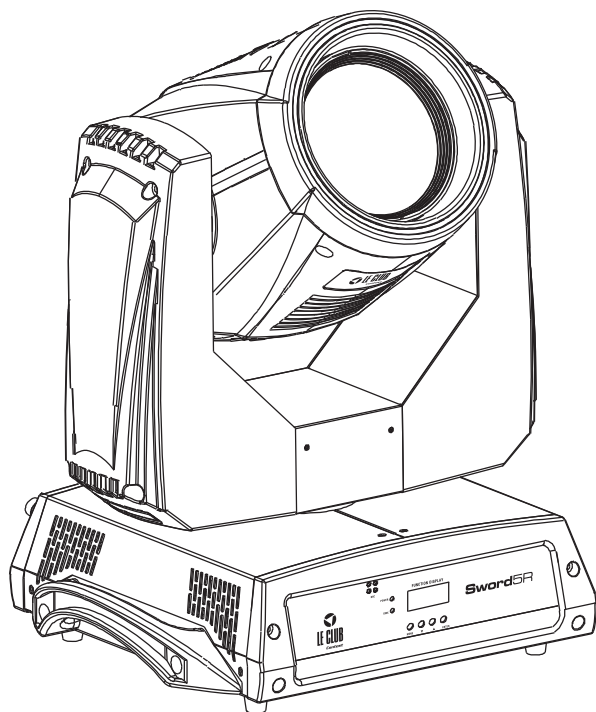

**BEAM MOVING HEAD WITH  
5R LAMP, 8-FACET PRISM,  
MOTORIZED FOCUS AND FROST**



**Sword5R**

**USER GUIDE**  
10409 - Version 1 / 11-2015

# 1 - Safety information

## Important safety information



This unit is intended for indoor use only. Do not use it in a wet, or extremely cold/hot locations. Failure to follow these safety instructions could result in fire, electric shock, injury, or damage to this product or other property.



Any maintenance procedure must be performed by a CONTEST authorised technical service. Basic cleaning operations must thoroughly follow our safety instructions.



This product contains non-isolated electrical components. Do not undertake any maintenance operation when it is switched on as it may result in electric shock.

## Symbols used



This symbol signals an important safety precaution.



The WARNING symbol signals a risk to the user's physical integrity. The product may also be damaged.



The CAUTION symbol signals a risk of product deterioration.

## Instructions and recommendations

### 1 - Please read carefully :

We strongly recommend to read carefully and understand the safety instructions before attempting to operate this unit.

### 2 - Please keep this manual :

We strongly recommend to keep this manual with the unit for future reference.

### 3 - Operate carefully this product :

We strongly recommend to take into consideration every safety instruction.

### 4 - Follow the instructions:

Please carefully follow each safety instruction to avoid any physical harm or property damage.

### 5 - Avoid water and wet locations :

Do not use this product in rain, or near washbasins or other wet locations.

### 6 - Installation :

We strongly encourage you to only use a fixation system or support recommended by the manufacturer or supplied with this product. Carefully follow the installation instructions and use the adequate tools. Always ensure this unit is firmly fixed to avoid vibration and slipping while operating as it may result in physical injury.

### 7 - Ceiling or wall installation :

Please contact your local dealer before attempting any ceiling or wall installation.

### 8 - Ventilation :

The cooling vents ensure a safe use of this product, and avoid any overheating risk. Do not obstruct or cover these vents as it may result in overheating and potential physical injury or product damage. This product should never be operated in a closed non-ventilated area such as a flight case or a rack, unless cooling vents are provided for the purpose.

### 9 - Heat exposure :

Sustained contact or proximity with warm surfaces may cause overheating and product damages. Please keep this product away from any heat source such as a heaters, amplifiers, hot plates, etc...

### 10 - Electric power supply :

This product can only be operated according to a very specific voltage. These information are specified on the label located at the rear of the product.

**CAUTION**

**RISK OF ELECTRIC SHOCK**

**DO NOT OPEN**

**WARNING:** This unit contains no user-serviceable parts. Do not open the housing or attempt any maintenance by yourself. In the unlikely even your unit may require service, please contact your nearest dealer.

In order to avoid any electrical malfunction, please do not use any multi-socket, power cord extension or connecting system without making sure they are perfectly isolated and present no defect.

**Warning**

This product is equipped with Class 2 LEDs.

Please avoid looking directly at the beam as it may cause severe eye injuries.

**Recycling your device**

- As HITMUSIC is really involved in the environmental cause, we only commercialise clean, ROHS compliant products.
- When this product reaches its end of life, take it to a collection point designated by local authorities. The separate collection and recycling of your product at the time of disposal will help conserve natural resources and ensure that it is recycled in a manner that protects human health and the environment.

### 11 - Power cords protection:

Power-supply cords should be routed so that they are not likely to be walked on or pinched by items placed upon or against them, paying particular attention to cords at lugs, convenience receptacles and the point where they exit from the fixture.

### 12 - Cleaning precautions :

Unplug the product before attempting any cleaning operation. This product should be cleaned only with accessories recommended by the manufacturer. Use a damp cloth to clean the surface. Do not wash this product.

### 13 - Long periods of non use :

Disconnect the unit's main power during long periods of non use.

### 14 - Liquids or objects penetration :

Do not let any object penetrate this product as it may result in electric shock or fire. Never spill any liquid on this product as it may infiltrate the electronic components and result in electric shock or fire.

### 15 - This product should be serviced when :

Please contact the qualified service personnel if :

- The power cord or the plug has been damaged.
- Objects have fallen or liquid has been spilled into the appliance.
- The appliance has been exposed to rain or water.
- The product does not appear to operate normally.
- The product has been damaged.

### 16 - Inspection/maintenance :

Please do not attempt any inspection or maintenance by yourself. Refer all servicing to qualified personnel.

### 17 - Operating environment :

Ambient temperature and humidity: +5 - +35°C, relative humidity must be less than 85% (when cooling vents are not obstructed). Do not operate this product in a non-ventilated, very humid or warm place.

## 2 - Technical specifications

### Light source

- › Philips® MSD PLATINUM 5R - 8000°K
- › Light output : 77000 lux at 5m
- › Beamwidth: 3.5°

### Effects

- › Strobe with adjustable speed, pulse effect and random strobe
- › Adjustable dimmer from 0 to 100%
- › Frost Filter
- › Motorized focus
- › Colour wheel with 14 colours + open via dichroic filters
- › Half-colours
- › Gobo wheel with 17 gobos + open
- › 8-facet rotating prism with adjustable speed
- › Gobo shake function

### Control

- › Standard DMX-512
- › 1, 12 and 16 DMX channels
- › Built-in music-sensitive programs (via internal mic)
- › Simplified command of several units via Master/Slave mode  
LCD drop-down menu to choose and assign the different modes

### Movements

- › PAN and TILT movements
- › Range: Pan 540° - Tilt 270°
- › PAN and TILT position memory and auto repositioning

### Package contents

The package must contain the following elements:

- Your SWORD5R
- 2 fixation brackets with Omega holders
- The user guide
- 1x2-pole + earth power cord / Powercon® socket

### Additional characteristics

- › Power consumption: 270 W maximum
- › Power supply: 100/230V, AC - 50/60Hz
- › Dimensions: 500 x 394 x 525 mm
- › Net weight: 18 Kg

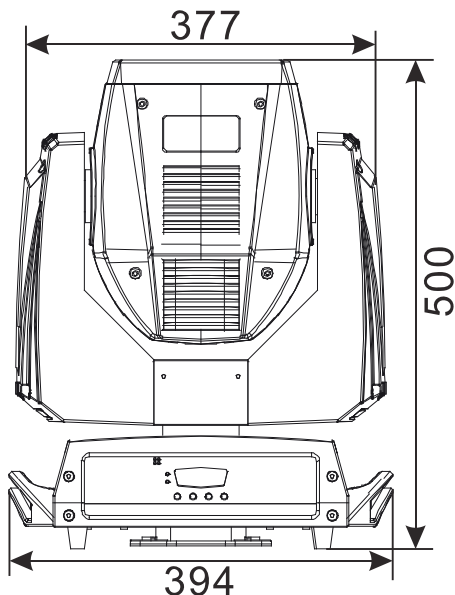
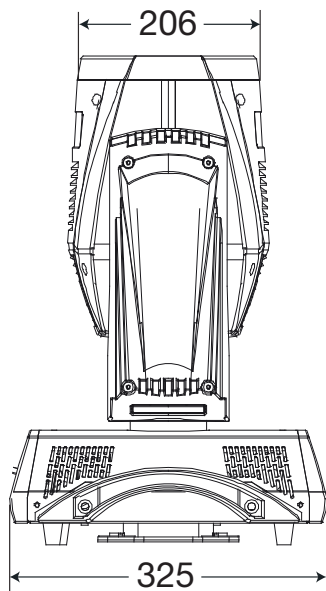

### 3 - Description

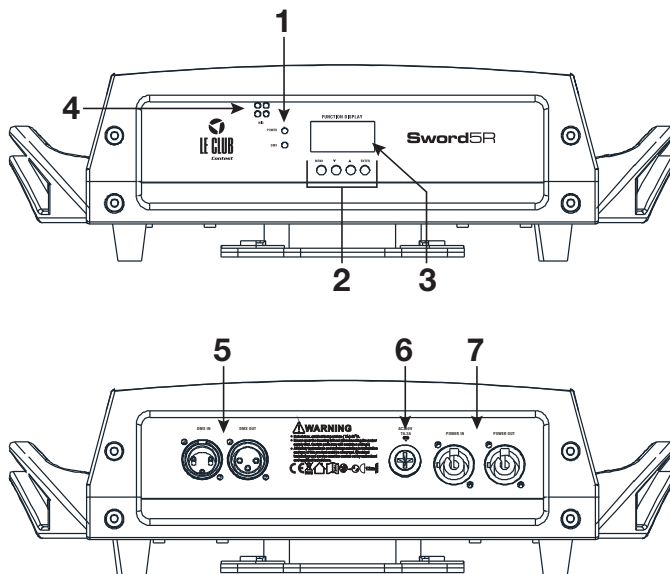

#### 1 Indicator LEDs

These 2 LEDs indicate the status of your device.

LED	Indication
DMX	Lights up when your device is in DMX mode
SOUND	Flashes when your device is in music-sensitive mode

#### 2 MENU Buttons

##### MENU button

Allows you to browse through menus and select a function.

##### ENTER button

Allows you to browse through menus and change values via the UP and DOWN buttons.

##### UP and DOWN buttons

Allows you to browse through menus and change values.

#### 3 Display

Allows you to configure your projector. Please refer to next chapter for more details.

The back-light can be deactivated from the menu via the Back Light function.

#### 4 Microphone

Allows music-sensitive modes.

#### 5 DMX Input /Output

3-pin female XLR plug hardwired as follows

- Mass: 1
- Negative signal: 2
- Positive signal: 3

#### 6 Fuse

If need to replace this fuse, please make sure the new one has the exact same characteristics.

#### 7 Power input/output

Powercon® Neutrik® sockets.

Allow you to power up your projector and daisy-chain extra projectors.

Please read the instructions carefully and make sure the voltage matches them.

You can daisy-chain up to 8 projectors with identical power requirements.

## 4 - Internal menu











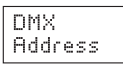





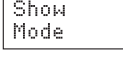



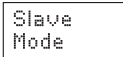

### 4.1 - Menu tree and description of the functions

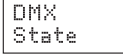
Your moving head will initialise the position of each motor upon activation.

The display will indicate  at this stage.

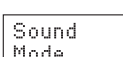
The display will then indicate  and you will be able to access the menu by pressing MENU or ENTER.

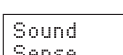
After a 30-second period of inactivity, the display will indicate  again and lock. Press ENTER to access it again.

MENU	UP and DOWN	Action	ENTER
		DMX address selection. Press ENTER, then use the UP and DOWN buttons to configure the address.	Saves changes
		1 channel: built-in programs (1 to 4) selection	Press ENTER, select a mode with UP and DOWN. Saves changes
		10 channels: Pan, Tilt, Movement speed, Dimmer, Strobe, Colour wheel, Gobo wheel, Prism, Prism rotation, Special functions	
		14 channels: Pan, Tilt, Movement speed, Dimmer, Strobe, Colour wheel, Gobo wheel, Prism, Prism rotation, Movements macros, Movements macro speed, Special function	
		Show 1 : PAN = 180° / TILT = 100°	Shows are music-sensitive. Please make sure the music-sensitive mode is activated (Sound State menu) and the microphone sensitivity has been set (Sound Sense menu). Please refer to chapter 4.3 for more details about the shows. Saves changes
		Show 2 : PAN = 180° / TILT = 100°	
		Show 3 : PAN = 540° / TILT = 180°	
		Show 4 : PAN = 540° / TILT = 100°	
		Allows you to activate the Master mode and adjust the behavior of slave devices: - Slave 1: The slave device reproduces precisely the movement of the master device. - Slave 2: The slave device reverses movements of the master device. Saves changes	
			
			
		Configure the behaviour of your projector in the event of DMX signal failure: • <b>Master</b> : The projector enters Master mode • <b>Hold</b> : The projector holds onto the last information received • <b>Blackout</b> : The projector blacks out Saves changes	
			
			
		Activates or deactivates the music-sensitive mode. Press ENTER and select On or Off via the UP and DOWN buttons. Saves changes	
			
		Allows you to adjust the microphone sensitivity for music-sensitive modes. 000 indicates the microphone is deactivated. Saves changes	

## 4.1 - Menu tree and functions (continuation and end)

MENU	UP and DOWN	Action	ENTER
Pan Inverse	No Yes	Reverses the PAN movement when the slave and show modes are activated, or in DMX mode. Press ENTER and select Yes or No via the UP and DOWN buttons.	Saves changes
Tilt Inverse	No Yes	Reverses the TILT movement when the slave and show modes are activated, or in DMX mode. Press ENTER and select Yes or No via the UP and DOWN buttons.	Saves changes
Back Light	On Off	Activates or deactivates the screen backlight. Press ENTER and select On or Off via the UP and DOWN buttons. When Off, the display will automatically turn off after a 30-second period of inactivity.	Saves changes
Auto Test	Test...	Launches an automatic test of every function.	Launches test
Fixture Time	xxx	Displays the total running time of your device since its very first initialisation.	No action
Lamp Time	xxx	Displays the total running time of the lamp since its very first initialisation.	No action
Lamp On	On Off	Allows you to manually turn on/off the lamp.	Saves changes
Lamp Power ON	On Off	Allows you to activate the lamp upon initialisation of your device.	Saves changes
Software Version	A :UX.X Ab:UX.X	Displays the current version of the internal software. <b>A</b> is the current main software version. <b>Ab</b> is the current booting software version.	No action
Pro Default	No Yes	Resets all parameters to factory settings.	Saves changes
Reset		Resets your device.	Resets

### 4.2 - Configuring initial positions

Upon initialisation, your moving head will adjust its motors onto their initial positions.

You can modify such positions so they meet your needs.

To do so, enter the **DMX Address** menu, then press ENTER for 3 seconds. Adjustable positions are listed below:

Pan Offset	-127 +127	PAN initial position settings.
Tilt Offset	-127 +127	TILT initial position settings.
Dimmer Offset	0 255	Dimmer initial value settings.
Gobo Offset	-127 +127	Gobo wheel initial position settings.
Color Offset	-127 +127	Colour wheel initial position settings.
Prism Offset	0 255	Prism initial position settings.
Frost Offset	0 255	Frost filter initial position settings.
Focus Offset	0 255	Focus initial position settings.

### 4.3 - Movement limitations based on programs used

In order to prevent your moving head from projecting beams over unwanted areas (ceilings, room angles, etc.) when automatic mode is activated, each show features its own PAN and TILT ranges. Please find below the movement limitations for each show.

Show 1

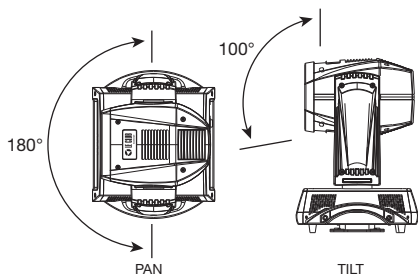

Show 2

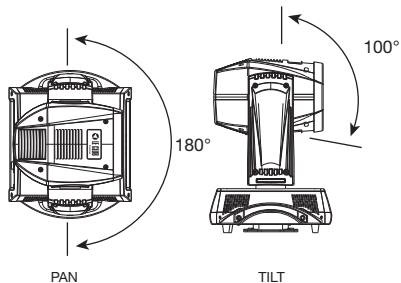

Show 3

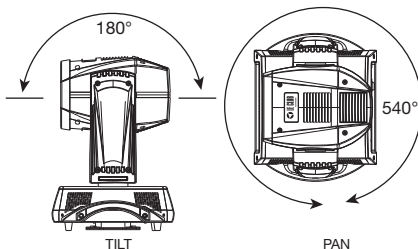

Show 4

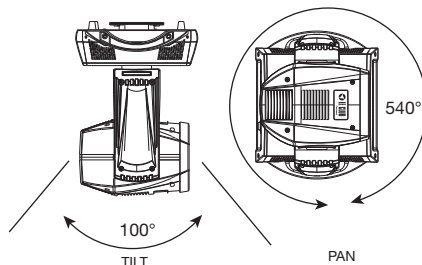

## 5 - Installation

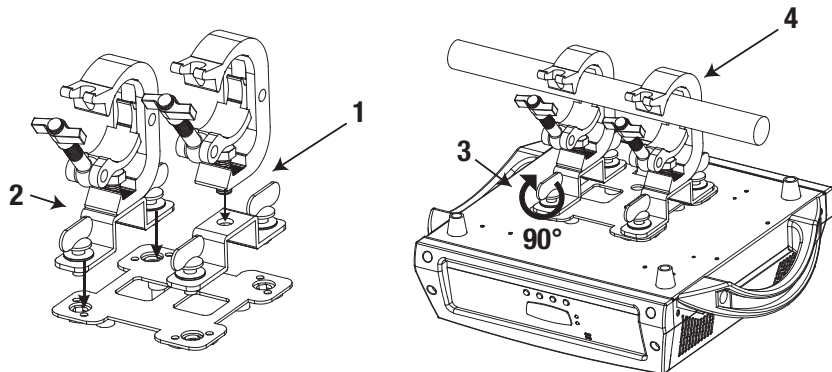

The SWORD5R moving head is supplied with two Quick-Lock fastening systems. The example above indicates how to install the Omega holders.

- 1- Attach Omega holders or hook clamps to the Quick-Lock systems.
- 2- Position your Omega - Quick-Lock systems on top of the drilled holes located below the RAY1R.
- 3- Rotate the Quick-Lock wing nuts a quarter turn.
- 4- Attach the Omega fixations to a structure and lock them.

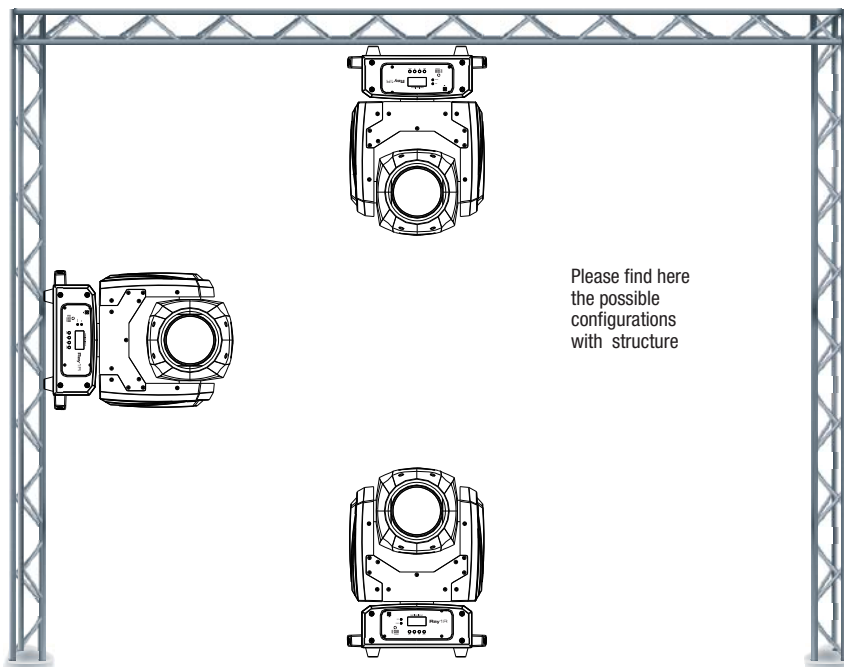

Please find here the possible configurations with structure



## 6 - Dmx channels and their functions

Your moving head will enter DMX mode as soon as a signal is detected via its DMX input.

### 6.1 - 1-channel mode

Channels	Values	Action
1	000 - 007	Black-out
	008 - 057	Show 1 in auto mode
	058 - 107	Show 2 in auto mode
	108 - 157	Show 3 in auto mode
	158 - 207	Show 4 in auto mode
	208 - 255	Show 1 to 4 in music-sensitive mode

### 5.2 - 12-channel mode

Channels	Values	Action
1	<b>PAN movement</b>	
	000 - 255	PAN movement settings
2	<b>Mouvement TILT</b>	
	000 - 255	TILT movement settings
3	<b>PAN and TILT movement speed</b>	
	000 - 255	Increasing speed
4	<b>Main dimmer</b>	
	000 - 255	Intensity from 0 to 100%
5	<b>Strobe</b>	
	000 - 003	Black-out
	004 - 103	Stroboscope at increasing speed
	104 - 107	Open
	108 - 207	Pulse effect at increasing speed
	208 - 212	Open
	213 - 225	Slow random strobe
	226 - 238	Regular random strobe
	239 - 251	Fast random strobe
	252 - 255	Open
6	<b>Colour wheel</b>	
	000 - 004	Open
	005 - 008	White / Red
	009 - 012	Red
	013 - 017	Red / Orange
	018 - 021	Orange
	022 - 025	Orange / Cyan
	026 - 029	Cyan
	030 - 034	Cyan / Green
	035 - 038	Green
	039 - 042	Green / Light green
	043 - 046	Light Green
	047 - 051	Light Green / Lilac
	052 - 055	Lilac
	056 - 059	Lilac / Pink
	060 - 063	Pink
	064 - 068	Pink / Yellow
069 - 072	Yellow	
073 - 076	Yellow / Magenta	

## 6.2 - 12-channel mode (continuation)

6 (Continuation)	077 - 081	Magenta
	082 - 085	Magenta / Blue
	086 - 089	Blue
	090 - 093	Blue / Temperature correction 1
	094 - 098	Temperature correction 1
	099 - 102	Temperature correction 1 / Temperature correction 2
	103 - 106	Temperature correction 2
	107 - 110	Temperature correction 2 / Temperature correction 3
	111 - 115	Temperature correction 3
	116 - 119	Temperature correction 3 / Congo
	120 - 123	Congo
	124 - 127	Congo / White
	128 - 255	Slow to fast Rainbow effect
	7	<b>Gobo wheel</b>
000 - 003		Open
004 - 007		Gobo 1
008 - 011		Gobo 2
012 - 015		Gobo 3
016 - 019		Gobo 4
020 - 023		Gobo 5
024 - 027		Gobo 6
028 - 031		Gobo 7
032 - 035		Gobo 8
036 - 039		Gobo 9
040 - 043		Gobo 10
044 - 047		Gobo 11
048 - 051		Gobo 12
052 - 055		Gobo 13
056 - 059		Gobo 14
060 - 063		Gobo 15
064 - 067		Gobo 16
068 - 071		Gobo 17
072 - 113		Fast to slow, counterclockwise gobo wheel rotation
114 - 117		Open
118 - 159		Slow to fast, clockwise gobo wheel rotation
160 - 164		Gobo 1 Shake from slow to fast
165 - 169		Gobo 2 Shake from slow to fast
170 - 174		Gobo 3 Shake from slow to fast
175 - 179		Gobo 4 Shake from slow to fast
180 - 184		Gobo 5 Shake from slow to fast
185 - 189		Gobo 6 Shake from slow to fast
190 - 194		Gobo 7 Shake from slow to fast
195 - 199		Gobo 8 Shake from slow to fast
200 - 204		Gobo 9 Shake from slow to fast
205 - 209		Gobo 10 Shake from slow to fast
210 - 214		Gobo 11 Shake from slow to fast
215 - 219		Gobo 12 Shake from slow to fast
220 - 224		Gobo 13 Shake from slow to fast
225 - 229		Gobo 14 Shake from slow to fast
230 - 234		Gobo 15 Shake from slow to fast
235 - 239	Gobo 16 Shake from slow to fast	
240 - 255	Gobo 17 Shake from slow to fast	

## 6.2 - 12-channel mode (continuation and end)

8	<b>Prism</b>	
	000 - 127	No function
	128 - 255	Prism
9	<b>Prism rotation</b>	
	000 - 127	Prism indexation from 0 to 45°
	128 - 190	Fast to slow, counterclockwise prism rotation
	191 - 192	No rotation
	193 - 255	Slow to fast, clockwise prism rotation
10	<b>Frost</b>	
	000 - 255	Frost effect from 0 to 100%
11	<b>Focus</b>	
	000 - 255	Focus from 0 to 100%
12	<b>Special functions</b>	
	000 - 079	No function
	080 - 084	Effects reset
	085 - 087	PAN and TILT movements reset
	088 - 090	Main reset
	091 - 100	No function
	101 - 120	Lamp off
	121 - 140	Lamp on
	141 - 160	No function
	161 - 180	Show 1 in auto mode
	181 - 200	Show 2 in auto mode
	201 - 220	Show 3 in auto mode
	221 - 240	Show 4 in auto mode
240 - 255	Show 1 to 4 in music-sensitive mode	

## 6.3 - 16-channel mode

Channels	Values	Action
1	<b>PAN movement</b>	
	000 - 255	PAN movement settings
2	<b>16-bit PAN movement</b>	
	000 - 255	Very precise PAN movement settings
3	<b>TILT movement</b>	
	000 - 255	TILT movement
4	<b>16-bit TILT movement</b>	
	000 - 255	Very precise TILT movement settings
5	<b>PAN and TILT movements speed</b>	
	000 - 255	Increasing speed
6	<b>Main dimmer</b>	
	000 - 255	Intensity from 0 to 100%
7	<b>Strobe</b>	
	000 - 003	Black-out
	004 - 103	Stroboscope at increasing speed
	104 - 107	Open
	108 - 207	Pulse effect at increasing speed
	208 - 212	Open
	213 - 225	Slow random strobe
	226 - 238	Regular random strobe
	239 - 251	Fast random strobe
	252 - 255	Open

## 6.3 - 16-channel mode (continuation)

8	<b>Colour wheel</b>	
	000 - 004	Open
	005 - 008	White / Red
	009 - 012	Red
	013 - 017	Red / Orange
	018 - 021	Orange
	022 - 025	Orange / Cyan
	026 - 029	Cyan
	030 - 034	Cyan / Green
	035 - 038	Green
	039 - 042	Green / Light green
	043 - 046	Light Green
	047 - 051	Light Green / Lilac
	052 - 055	Lilac
	056 - 059	Lilac / Pink
	060 - 063	Pink
	064 - 068	Pink / Yellow
	069 - 072	Yellow
	073 - 076	Yellow / Magenta
	077 - 081	Magenta
	082 - 085	Magenta / Blue
	086 - 089	Blue
	090 - 093	Blue / Temperature correction 1
	094 - 098	Temperature correction 1
	099 - 102	Temperature correction 1 / Temperature correction 2
	103 - 106	Temperature correction 2
	107 - 110	Temperature correction 2 / Temperature correction 3
	111 - 115	Temperature correction 3
116 - 119	Temperature correction 3 / Congo	
120 - 123	Congo	
124 - 127	Congo / White	
128 - 255	Slow to fast Rainbow effect	
9	<b>Gobo wheel</b>	
	000 - 003	Open
	004 - 010	Gobo 1
	011 - 016	Gobo 2
	017 - 022	Gobo 3
	023 - 027	Gobo 4
	028 - 031	Gobo 5
	032 - 035	Gobo 6
	036 - 039	Gobo 7
	040 - 043	Gobo 8
	044 - 047	Gobo 9
	048 - 051	Gobo 10
	052 - 055	Gobo 11
	056 - 059	Gobo 12
	060 - 063	Gobo 13
	064 - 067	Gobo 14
	068 - 071	Gobo 15
	064 - 067	Gobo 16
	068 - 071	Gobo 17
	072 - 113	Fast to slow, counterclockwise gobo wheel rotation
114 - 117	Open	
118 - 159	Slow to fast, clockwise gobo wheel rotation	

## 6.3 - 16-channel mode (continuation)

9 (continuation)	160 - 164	Gobo 1 Shake from slow to fast
	165 - 169	Gobo 2 Shake from slow to fast
	170 - 174	Gobo 3 Shake from slow to fast
	175 - 179	Gobo 4 Shake from slow to fast
	180 - 184	Gobo 5 Shake from slow to fast
	185 - 189	Gobo 6 Shake from slow to fast
	190 - 194	Gobo 7 Shake from slow to fast
	195 - 199	Gobo 8 Shake from slow to fast
	200 - 204	Gobo 9 Shake from slow to fast
	205 - 209	Gobo 10 Shake from slow to fast
	210 - 214	Gobo 11 Shake from slow to fast
	215 - 219	Gobo 12 Shake from slow to fast
	220 - 224	Gobo 13 Shake from slow to fast
	225 - 229	Gobo 14 Shake from slow to fast
	230 - 234	Gobo 15 Shake from slow to fast
	235 - 239	Gobo 16 Shake from slow to fast
	240 - 255	Gobo 17 Shake from slow to fast
10	<b>Prism</b>	
	000 - 127	No function
	128 - 255	Prism
11	<b>Prism rotation</b>	
	000 - 127	Prism indexation from 0 to 45°
	128 - 190	Fast to slow, clockwise prism rotation
	191 - 192	No rotation
193 - 255	Slow to fast, counterclockwise prism rotation	
12	<b>Frost</b>	
	000 - 255	Frost effect from 0 to 100%
13	<b>Focus</b>	
	000 - 255	Focus from 0 to 100%
14	<b>PAN/TILT movement macros</b>	
	000 - 007	No function
	008 - 015	Macro 1
	016 - 023	Macro 2
	024 - 031	Macro 3
	032 - 039	Macro 4
	040 - 047	Macro 5
	048 - 055	Macro 6
	056 - 063	Macro 7
	064 - 071	Macro 8
	072 - 079	Macro 9
	080 - 087	Macro 10
	088 - 095	Macro 11
	096 - 103	Macro 12
	104 - 111	Macro 13
	112 - 119	Macro 14
	120 - 127	Macro 15
	128 - 135	Macro 16
	136 - 143	Macro 17
	144 - 151	Macro 18
	152 - 159	Macro 19
	160 - 167	Macro 20
	176 - 183	Macro 22
	184 - 191	Macro 23
	192 - 199	Macro 24

6.3 - 16-channel mode (continuation and end)

14 (continuation)	200 - 207	Macro 25
	208 - 215	Macro 26
	216 - 223	Macro 27
	224 - 231	Macro 28
	232 - 239	Macro 29
	240 - 247	Macro 30
15	<b>Movement macros speed</b>	
	000 - 127	Increasing speed
	128 - 255	Music-sensitive mode
16	<b>Special functions</b>	
	000 - 079	No function
	080 - 084	Effects reset
	085 - 087	PAN and TILT movements reset
	088 - 090	Main reset
	091 - 100	No function
	101 - 120	Lamp off
	121 - 140	Lamp on
	141 - 160	No function
	161 - 180	Show 1 in auto mode
	181 - 200	Show 2 in auto mode
	201 - 220	Show 3 in auto mode
	221 - 240	Show 4 in auto mode
	240 - 255	Show 1 to 4 in music-sensitive mode

7 - Cabling, addressing and daisy chaining

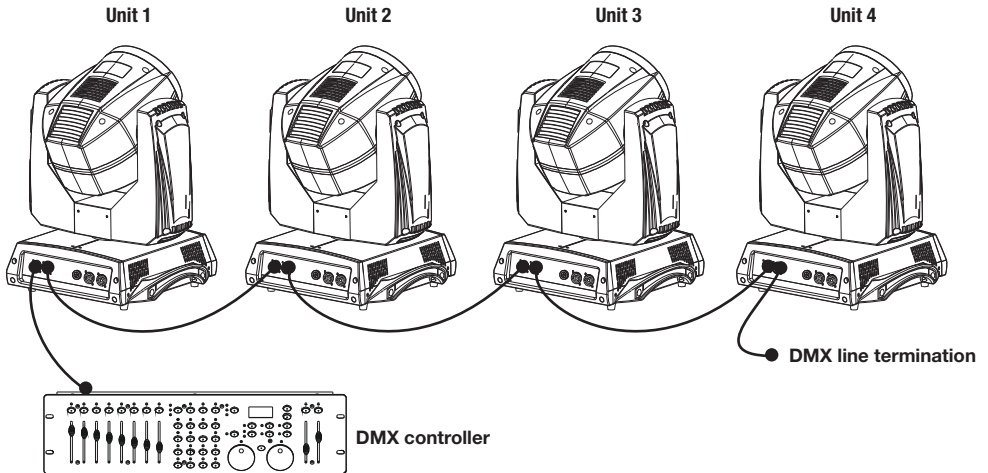

DMX Mode	Unit 1 address	Unit 2 address	Unit 3 address	Unit 4 address
1 channel	1	2	3	4
12 channels	1	13	25	37
16 channels	1	17	33	49

## 8 - Gobos and colours

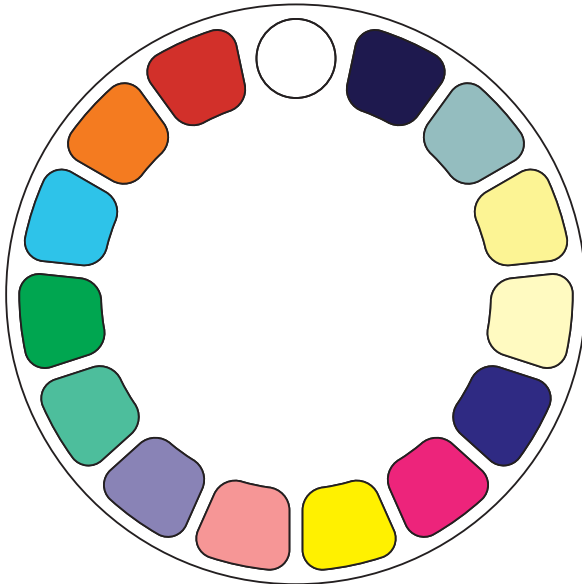
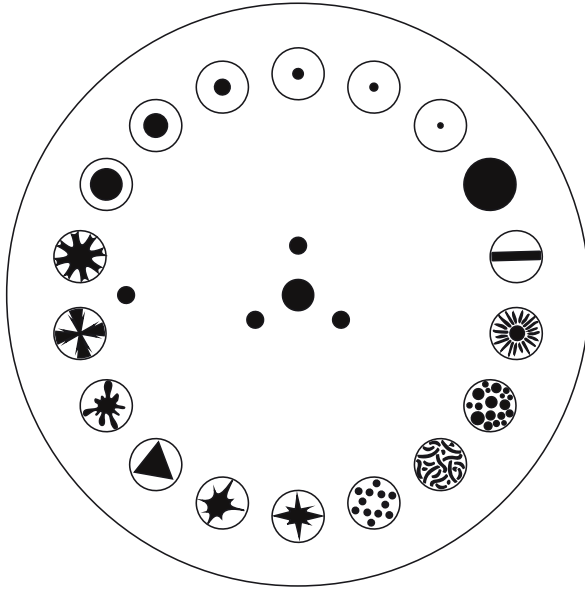

Because CONTEST® takes the utmost care in its products to make sure you only get the best possible quality, our products are subjects to modifications without prior notice. That is why technical specifications and the products physical configuration might differ from the illustrations.

Make sure you get the latest news and updates about the CONTEST® products on [www.contest-lighting.com](http://www.contest-lighting.com)  
CONTEST® is a trademark of HITMUSIC S.A. - Zone Cahors sud - 46230 FONTANES - FRANCE